

PANTHELLA 250 TABLE LAMP

The fixture emits a glare-free, soft and comfortable illumination. The metal shade versions direct the light directly downwards and create a pleasant illumination due to the inner white painted shade and the reflection from the trumpet-shaped stem. The opal acrylic produces a diffused comfortable light due to the translucent shade, the downward reflection from the inner shade and the reflection from the trumpet-shaped stem.

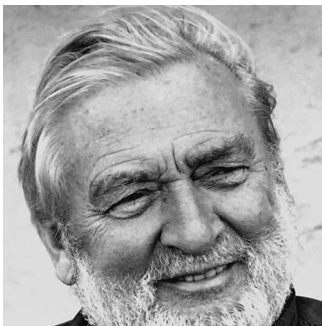

Verner Panton

Verner Panton (1926-1998) is famous for his inspirational and colorful personality. A unique person with a special sense for color, shape, light function and space. Over the course of his career, Panton introduced a series of modern lamps with personalities unlike any of his Scandinavian contemporaries.

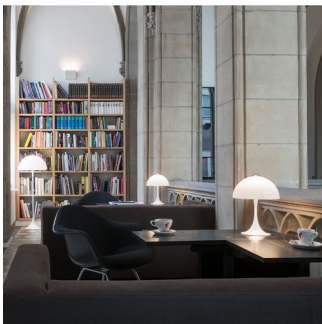

Set location -
The Qvest



Product info

Information

Electrical: System Wattage: 10W LED Wattage: 9W Delivered lumens: 428-589 Efficacy: 42 - 58 lm/W (LED)
 Certifications: cULus, Dry Location Protection class IP20 Controllability: Continuous dimming by touch switch on cord. Color Rendering: Ra \geq 90

Mounting

Cable type: White for brass, pale rose and white finishes; Black for other finishes. Cable length: 8'. LED-driver: Separate, plugs into power outlet. Light control: In-line switch. Auto shut-off timer: 4 hours/8 hours. Continuous dimming from 15% to 100%.

Finish

White Opal Acrylic shade with white stand. Gray Opal Acrylic shade with high-luster chrome stand. High-Luster Chrome shade and stand. Metalized Brass shade and stand. White, Black, or Orange shade and stand, Powder-coated.

Materials

Shade: Injection-molded acrylic or deep-drawn steel. Base and housing: Cast aluminum. Diffuser: Injection-molded opal pmma.

Sizes and weight

Width x Height x Length (in.) | 9.8 x 13.2 x 9.8 Max 2.6 lbs

Compliance

cULus, Dry location.

Light source

LED 2700K
 Lumen: 428

Information

Electrical:
 System Wattage: 10W
 LED Wattage: 9W
 Delivered lumens: 428-589
 Efficacy: 42 - 58 lm/W (LED)
 Certifications:
 cULus, Dry Location
 Protection class IP20
 Controllability: Continuous dimming by touch switch on cord.
 Color Rendering: Ra \geq 90



Related products



Panthella 320 Table Lamp

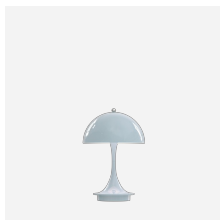

Panthella 160 Portable



Panthella Floor

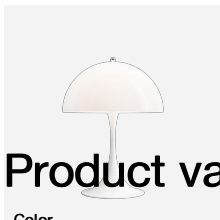

Product variants

Color	Cable type	Light source	Lumen	Voltage frequency
Panthella 400 Table Lamp				
<input checked="" type="radio"/> Black	-	LED 2700K	428	-
<input type="radio"/> Brass metalized	Blk		460	120V
<input type="radio"/> Coral	Wht		589	
<input type="radio"/> Grey opal acrylic			679	
<input type="radio"/> High lustre chrome plated				
<input type="radio"/> Orange				
<input type="radio"/> Pale blue				
<input type="radio"/> Pale rose				
<input type="radio"/> White				
<input type="radio"/> White opal acrylic				

Product description

The fixture emits a soft, comfortable, glare-free, light. The metal-shade versions direct the light directly downward, creating a pleasant illumination due to the inner white-painted shade and the reflection from the trumpet-shaped stem. The opal acrylic produces a diffused, comfortable light due to the translucent shade, the downward reflection from the inner shade, and the reflection from the trumpet-shaped stem.

Light description

The fixture emits a soft, comfortable, glare-free, light. The metal-shade versions shield from upward light while the opal acrylic shade provides pleasant upward illumination.

Design

Verner Panton

Material

"Shade: Injection-molded acrylic or deep-drawn steel. Base and housing: Cast aluminum.

Diffuser: Injection-molded opal pmma. Cable type: White for brass, pale rose and white finishes; Black for other finishes. Cable length: 8'. Switch: In-line on/off. Diffuser with"

Weight

Min: 2.601 lbs Max: 2.601 lbs

Other functions

White cord on white opal, white metal, and metalized brass versions. Black cord on all other versions. LED driver fitted externally on cord. Turn on/off with the light fading in/out. Stepless dimming of the light to a suitable level between 15 and 100%. Timer function to automatically turn off the light after a period of time, selectable between 4 hours or 8 hours. Function to set a fixed brightness level each time the lamp is connected to main power. For an LED replacement kit, please contact Louis Poulsen.

Finish

Black, Brass metalized, Coral, Grey opal acrylic, High lustre chrome plated, Orange, Pale blue, Pale rose, White, White opal acrylic

Voltage

120V

Light distribution diagrams

Cartesian

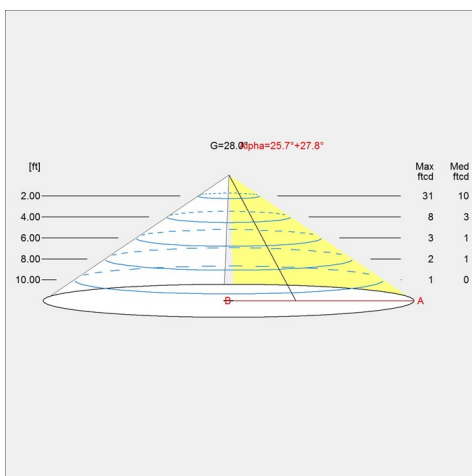

Isolux

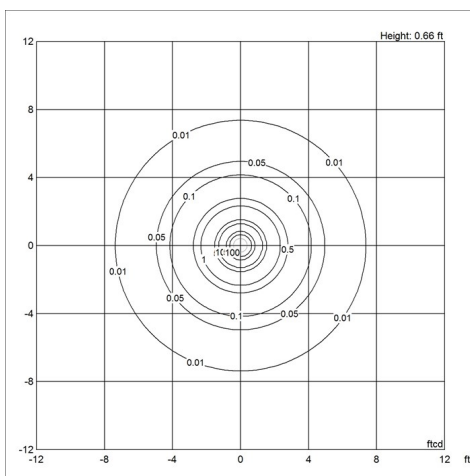

Polar

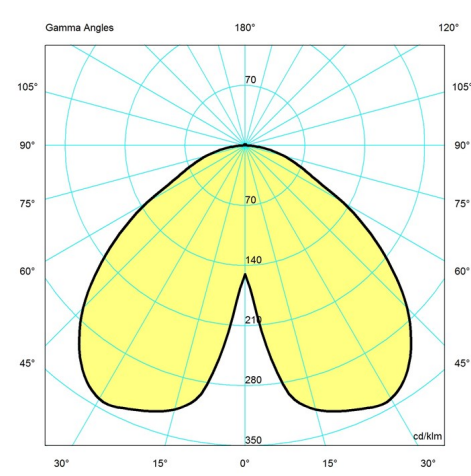

Spare parts & accessories

Panthella 250 Table Lamp

Product	Variant number
PANTHELLA 250 TABLE LAMP TOP NUT	5744166234
PANTHELLA 250 TABLE SHADE YELLOW/GREEN	5744166247
PANTHELLA 250 TABLE LAMP SHADE WHITE	5744166250
PANTHELLA 250 TABLE LAMP SHADE BLACK	5744166263
PANTHELLA 250 TABLE LAMP SHADE BLUE/GREEN	5744166276
PANTHELLA 250 TABLE LAMP SHADE PINK	5744166289
PANTHELLA 250 TABLE LAMP SHADE BLUE	5744166292
PANTHELLA 250 TABLE LAMP SHADE RED	5744166302
PANTHELLA 250 TABLE LAMP SHADE YELLOW	5744166315
PANTHELLA 250 TABLE LAMP SHADE ORANGE	5744166328
PANTHELLA 250 TABLE LAMP SHADE VIOLET	5744166331
PANTHELLA 250 TABLE LAMP SHADE OPAL	5744166344
PANTHELLA 250 TABLE LAMP SHADE CHROME	5744162568
PANTHELLA 250 TABLE LAMP DIFFUSER	5744161828
PANTHELLA 250 TABLE LAMP SHADE BRASS PVD	5744167589
PANTHELLA 250 TABLETOP NUT BRASS PVD	5744167660
PANTHELLA 250 TABLE LAMP SHADE OPAL GREY	5744168054
PANTHELLA 250 TABLE SHADE PALE BLUE	5744612704
PANTHELLA 250 TABLE SHADE CORAL	5744612717
PANTHELLA 250 TABLE SHADE PALE ROSE NEW	5744902087
Panthella MINI white cord	5744168436
PANTHELLA 250 TABLE LAMP CORD BLK	5744168533
ADAPTOR 12V BLK	5744164867
ADAPTOR 12V WHT	5744164870