

# CIRRUS SUSPENSION R1

## RECTANGULAR R1 WITH REMOTE POWER, END FEED

DESIGNED BY GREGORY KAY | ASSEMBLED IN AMERICA

REV 06.09.20



### DESCRIPTION

Cirrus R1 End Feed Suspension with Remote 24VDC Power Supply (sold separately) is a linear LED fixture that offers direct light in a clean, contemporary style. Featuring a Diffused White Rectangular Lens with a 140° Beam Spread available in various increments from 12"-420" and multiple finish options. The Cirrus R1 Suspension comes in nine color temperatures ranging from 2200k to 5700k, including two Warm Dim options of **(27D)** 2700K or **(30D)** 3000K that dim down to 2000K. Fixture includes a 5 year pro-rated warranty. For custom lengths and quotes, email our Design Team: [design@PureEdgeLighting.com](mailto:design@PureEdgeLighting.com).

Wattages for this fixture are available in the following options:

- 2W - 2.5 Watts per Foot, Lengths up to 420" (35')
- 5W - 4.4 Watts per Foot, Lengths up to 240" (20')
- 7W - 7.3 Watts per Foot, Lengths up to 160" (13.3')
- 10W - 9.6 Watts per Foot, Lengths up to 120" (10')

### INSTALLATION

- Mounts to a Standard Junction Box, pre-wired from either a 120V with a 60 Watt NON-IC (50W-IC) Power Supply that fits in the ceiling Electrical Junction Box, or from a Remote Power Supply feeding 24VDC up to 100 Watts at a maximum of 40' away
- Includes Canopy of your choice: 2.8" or 4.6", available in Round or Square, Pairs - One for remote power and one for a blank end cap, and VR (Vanishing Point)
- Includes adjustable 12' Coaxial and Aircraft Cables (additional Aircraft Cables included for support when fixture exceeds 96")
- Remote Power Supplies sold separately

### FINISHES

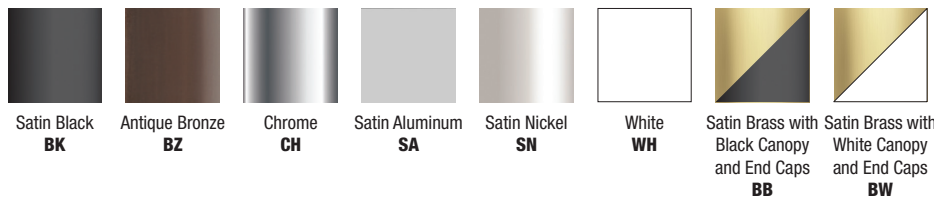

System	Wattage Per Foot	Canopy	Nominal Size (Inches)	Color Temperature	Finish
<b>CSR1</b>	<b>2W</b>	<b>2R</b>	<b>420</b>	<b>22K</b>	<b>SN</b>
<b>CSR1</b> Cirrus Suspension Rectangular 1 Lens	<b>2W</b> 2.5 Watts (420" max, 35') <b>5W</b> 5 Watts (240" max, 20') <b>7W</b> 7.5 Watts (160" max, 13.3') <b>10W</b> 10 Watts (120" max, 10')	<b>2R</b> 2.8" Round Canopy <b>2S</b> 2.8" Square Canopy <b>4R</b> 4.6" Round Canopy <b>4S</b> 4.6" Square Canopy <b>VR</b> Vanishing Point Plaster in system with No Canopy <b>2R2</b> 2 x 2.8" Round Canopies <b>2S2</b> 2 x 2.8" Square Canopies <b>4R2</b> 2 x 4.6" Round Canopies <b>4S2</b> 2 x 4.6" Square Canopies	<b>12-420</b> Order in various increments from 12"-420".  *Maximum shipping length for Chrome is 84"  **See length chart on pgs 2-3 for exact dimensions	<b>22K</b> 2200K Amber White <b>24K</b> 2400K Very Warm White <b>27K</b> 2700K Incandescent White <b>27D</b> 2700K Warm Dim (5W only, 20' max) <b>30K</b> 3000K Warm White <b>30D</b> 3000K Warm Dim (5W only, 20' max) <b>35K</b> 3500K Neutral White <b>40K</b> 4000K Cool White <b>57K</b> 5700K Daylight White	<b>BK</b> Satin Black <b>BZ</b> Antique Bronze <b>CH</b> Chrome <b>SA</b> Satin Aluminum <b>SN</b> Satin Nickel <b>WH</b> White <b>BB</b> Satin Brass with Black Canopy and End Caps <b>BW</b> Satin Brass with White Canopy and End Caps

### LENSES

Diffused White R1 Rectangular Lens, 140° Beam Spread

### APPLICATIONS

Designed for indoor use only. Ideal applications in Residential, Commercial, Retail, and Hospitality environments.

### LAMPING OPTIONS

- Choose from 9 different Color Temperatures from 2200K-5700K including Warm Dim
- Warm Dim: 2700K-2000K **(27D)** or 3000K-2000K **(30D)**
- 50,000 Hour Lamp Life

### REMOTE POWER SUPPLIES\*, DIMMERS & CONTROLS (SOLD SEPARATELY)

- UNI Driver (ELV, 0-10, TRIAC)
- Lutron Hi-Lume®
- Electronic Low Voltage Dimming (ELV)
- 0-10 Volt Dimming **(0-10V)**

\*In-Wall Mounting Kits available for select power supplies

### APPROVALS:

Class 2 Wiring, Damp Location Suitable, ETL listed. Title 24 with Universal Power Supply

PROJECT		FIXTURE TYPE		DATE	
---------	--	--------------	--	------	--

# CIRRUS SUSPENSION R1

## RECTANGULAR R1 WITH REMOTE POWER, END FEED

### LENGTH CHART Actual lengths for Cirrus Suspension R1

22K, 24K, 27K, 30K, 35K, 40K & 57K									
Ordering Code (Nominal Size)	Actual Length	2W (2.5 Watts)	Power Supply	5W (5 Watts)	Power Supply	7W (7 Watts)	Power Supply	10W (10 Watts)	Power Supply
12	13.1	2	PSB-40W-UNI-24VDC	5	PSB-40W-UNI-24VDC	8	PSB-40W-UNI-24VDC	10	PSB-40W-UNI-24VDC
15	15.5	3	PSB-40W-UNI-24VDC	6	PSB-40W-UNI-24VDC	9	PSB-40W-UNI-24VDC	12	PSB-40W-UNI-24VDC
17	17.9	4	PSB-40W-UNI-24VDC	7	PSB-40W-UNI-24VDC	11	PSB-40W-UNI-24VDC	14	PSB-40W-UNI-24VDC
20	20.3	4	PSB-40W-UNI-24VDC	8	PSB-40W-UNI-24VDC	13	PSB-40W-UNI-24VDC	17	PSB-40W-UNI-24VDC
22	22.7	5	PSB-40W-UNI-24VDC	9	PSB-40W-UNI-24VDC	14	PSB-40W-UNI-24VDC	18	PSB-40W-UNI-24VDC
24	25.1	5	PSB-40W-UNI-24VDC	10	PSB-40W-UNI-24VDC	15	PSB-40W-UNI-24VDC	20	PSB-40W-UNI-24VDC
27	27.5	6	PSB-40W-UNI-24VDC	11	PSB-40W-UNI-24VDC	17	PSB-40W-UNI-24VDC	22	PSB-40W-UNI-24VDC
29	29.9	6	PSB-40W-UNI-24VDC	12	PSB-40W-UNI-24VDC	18	PSB-40W-UNI-24VDC	24	PSB-40W-UNI-24VDC
32	32.3	7	PSB-40W-UNI-24VDC	13	PSB-40W-UNI-24VDC	20	PSB-40W-UNI-24VDC	27	PSB-40W-UNI-24VDC
34	34.7	7	PSB-40W-UNI-24VDC	14	PSB-40W-UNI-24VDC	21	PSB-40W-UNI-24VDC	28	PSB-40W-UNI-24VDC
36	37.1	7	PSB-40W-UNI-24VDC	15	PSB-40W-UNI-24VDC	23	PSB-40W-UNI-24VDC	30	PSB-40W-UNI-24VDC
39	39.5	8	PSB-40W-UNI-24VDC	16	PSB-40W-UNI-24VDC	24	PSB-40W-UNI-24VDC	32	PSB-40W-UNI-24VDC
41	41.9	9	PSB-40W-UNI-24VDC	17	PSB-40W-UNI-24VDC	26	PSB-40W-UNI-24VDC	34	PSB-40W-UNI-24VDC
44	44.3	9	PSB-40W-UNI-24VDC	18	PSB-40W-UNI-24VDC	28	PSB-40W-UNI-24VDC	37	PSB-40W-UNI-24VDC
46	46.7	10	PSB-40W-UNI-24VDC	19	PSB-40W-UNI-24VDC	29	PSB-40W-UNI-24VDC	38	PSB-40W-UNI-24VDC
48	49.1	10	PSB-40W-UNI-24VDC	20	PSB-40W-UNI-24VDC	30	PSB-40W-UNI-24VDC	40	PSB-60W-UNI-24VDC
51	51.5	11	PSB-40W-UNI-24VDC	21	PSB-40W-UNI-24VDC	32	PSB-40W-UNI-24VDC	42	PSB-60W-UNI-24VDC
53	53.9	11	PSB-40W-UNI-24VDC	22	PSB-40W-UNI-24VDC	33	PSB-40W-UNI-24VDC	44	PSB-60W-UNI-24VDC
56	56.3	12	PSB-40W-UNI-24VDC	23	PSB-40W-UNI-24VDC	35	PSB-40W-UNI-24VDC	47	PSB-60W-UNI-24VDC
58	58.7	12	PSB-40W-UNI-24VDC	24	PSB-40W-UNI-24VDC	36	PSB-40W-UNI-24VDC	48	PSB-60W-UNI-24VDC
60	61.1	12	PSB-40W-UNI-24VDC	25	PSB-40W-UNI-24VDC	38	PSB-40W-UNI-24VDC	50	PSB-60W-UNI-24VDC
63	63.5	13	PSB-40W-UNI-24VDC	26	PSB-40W-UNI-24VDC	39	PSB-40W-UNI-24VDC	52	PSB-60W-UNI-24VDC
65	65.9	14	PSB-40W-UNI-24VDC	27	PSB-40W-UNI-24VDC	41	PSB-60W-UNI-24VDC	54	PSB-60W-UNI-24VDC
68	68.3	14	PSB-40W-UNI-24VDC	28	PSB-40W-UNI-24VDC	43	PSB-60W-UNI-24VDC	57	PSB-60W-UNI-24VDC
70	70.7	15	PSB-40W-UNI-24VDC	29	PSB-40W-UNI-24VDC	44	PSB-60W-UNI-24VDC	58	PSB-60W-UNI-24VDC
72	73.1	15	PSB-40W-UNI-24VDC	30	PSB-40W-UNI-24VDC	45	PSB-60W-UNI-24VDC	60	PSB-96W-UNI-24VDC
75	75.5	16	PSB-40W-UNI-24VDC	31	PSB-40W-UNI-24VDC	47	PSB-60W-UNI-24VDC	62	PSB-96W-UNI-24VDC
77	77.9	16	PSB-40W-UNI-24VDC	32	PSB-40W-UNI-24VDC	48	PSB-60W-UNI-24VDC	64	PSB-96W-UNI-24VDC
80	80.3	17	PSB-40W-UNI-24VDC	33	PSB-40W-UNI-24VDC	50	PSB-60W-UNI-24VDC	67	PSB-96W-UNI-24VDC
82	82.7	17	PSB-40W-UNI-24VDC	34	PSB-40W-UNI-24VDC	51	PSB-60W-UNI-24VDC	68	PSB-96W-UNI-24VDC
84*	85.1	17	PSB-40W-UNI-24VDC	35	PSB-40W-UNI-24VDC	53	PSB-60W-UNI-24VDC	70	PSB-96W-UNI-24VDC
87	87.5	18	PSB-40W-UNI-24VDC	36	PSB-40W-UNI-24VDC	54	PSB-60W-UNI-24VDC	72	PSB-96W-UNI-24VDC
89	89.9	19	PSB-40W-UNI-24VDC	37	PSB-40W-UNI-24VDC	56	PSB-60W-UNI-24VDC	74	PSB-96W-UNI-24VDC
92	92.3	19	PSB-40W-UNI-24VDC	38	PSB-40W-UNI-24VDC	58	PSB-60W-UNI-24VDC	77	PSB-96W-UNI-24VDC
94	94.7	20	PSB-40W-UNI-24VDC	39	PSB-40W-UNI-24VDC	59	PSB-60W-UNI-24VDC	78	PSB-96W-UNI-24VDC
96	97.1	20	PSB-40W-UNI-24VDC	40	PSB-60W-UNI-24VDC	60	PSB-96W-UNI-24VDC	80	PSB-96W-UNI-24VDC
99	99.5	21	PSB-40W-UNI-24VDC	41	PSB-60W-UNI-24VDC	62	PSB-96W-UNI-24VDC	82	PSB-96W-UNI-24VDC
101	101.9	21	PSB-40W-UNI-24VDC	42	PSB-60W-UNI-24VDC	63	PSB-96W-UNI-24VDC	84	PSB-96W-UNI-24VDC
104	104.3	22	PSB-40W-UNI-24VDC	43	PSB-60W-UNI-24VDC	65	PSB-96W-UNI-24VDC	87	PSB-96W-UNI-24VDC
106	106.7	22	PSB-40W-UNI-24VDC	44	PSB-60W-UNI-24VDC	66	PSB-96W-UNI-24VDC	88	PSB-96W-UNI-24VDC
108	109.1	22	PSB-40W-UNI-24VDC	45	PSB-60W-UNI-24VDC	68	PSB-96W-UNI-24VDC	90	PSB-96W-UNI-24VDC
111	111.5	23	PSB-40W-UNI-24VDC	46	PSB-60W-UNI-24VDC	69	PSB-96W-UNI-24VDC	92	PSB-96W-UNI-24VDC
113	113.9	24	PSB-40W-UNI-24VDC	47	PSB-60W-UNI-24VDC	71	PSB-96W-UNI-24VDC	94	PSB-96W-UNI-24VDC
116	116.3	24	PSB-40W-UNI-24VDC	48	PSB-60W-UNI-24VDC	73	PSB-96W-UNI-24VDC	97	PSB-100W-ELV-24VDC
118	118.7	25	PSB-40W-UNI-24VDC	49	PSB-60W-UNI-24VDC	74	PSB-96W-UNI-24VDC	98	PSB-100W-ELV-24VDC
120**	121.1	25	PSB-40W-UNI-24VDC	50	PSB-60W-UNI-24VDC	75	PSB-96W-UNI-24VDC	100	PSB-100W-ELV-24VDC
123	123.6	26	PSB-40W-UNI-24VDC	51	PSB-60W-UNI-24VDC	77	PSB-96W-UNI-24VDC		
125	126.0	26	PSB-40W-UNI-24VDC	52	PSB-60W-UNI-24VDC	78	PSB-96W-UNI-24VDC		
128	128.4	27	PSB-40W-UNI-24VDC	53	PSB-60W-UNI-24VDC	80	PSB-96W-UNI-24VDC		
130	130.8	27	PSB-40W-UNI-24VDC	54	PSB-60W-UNI-24VDC	81	PSB-96W-UNI-24VDC		
132	133.2	28	PSB-40W-UNI-24VDC	55	PSB-60W-UNI-24VDC	83	PSB-96W-UNI-24VDC		
135	135.6	28	PSB-40W-UNI-24VDC	56	PSB-60W-UNI-24VDC	84	PSB-96W-UNI-24VDC		
137	138.0	29	PSB-40W-UNI-24VDC	57	PSB-60W-UNI-24VDC	86	PSB-96W-UNI-24VDC		
140	140.4	29	PSB-40W-UNI-24VDC	58	PSB-60W-UNI-24VDC	87	PSB-96W-UNI-24VDC		
142	142.8	30	PSB-40W-UNI-24VDC	59	PSB-60W-UNI-24VDC	89	PSB-96W-UNI-24VDC		
144	145.2	30	PSB-40W-UNI-24VDC	60	PSB-96W-UNI-24VDC	90	PSB-96W-UNI-24VDC		
147	147.6	31	PSB-40W-UNI-24VDC	61	PSB-96W-UNI-24VDC	92	PSB-96W-UNI-24VDC		
149	150.0	31	PSB-40W-UNI-24VDC	62	PSB-96W-UNI-24VDC	93	PSB-96W-UNI-24VDC		
152	152.4	32	PSB-40W-UNI-24VDC	63	PSB-96W-UNI-24VDC	95	PSB-96W-UNI-24VDC		
154	154.8	32	PSB-40W-UNI-24VDC	64	PSB-96W-UNI-24VDC	96	PSB-96W-UNI-24VDC		
156	157.2	33	PSB-40W-UNI-24VDC	65	PSB-96W-UNI-24VDC	98	PSB-100W-ELV-24VDC		
159	159.6	33	PSB-40W-UNI-24VDC	66	PSB-96W-UNI-24VDC	99	PSB-100W-ELV-24VDC		
161	162.0	34	PSB-40W-UNI-24VDC	67	PSB-96W-UNI-24VDC				
164	164.4	34	PSB-40W-UNI-24VDC	68	PSB-96W-UNI-24VDC				
166	166.8	35	PSB-40W-UNI-24VDC	69	PSB-96W-UNI-24VDC				

\*Maximum Chrome Length \*\*Maximum Shipping Length

PROJECT		FIXTURE TYPE		DATE	
---------	--	--------------	--	------	--

# CIRRUS SUSPENSION R1

## RECTANGULAR R1 WITH REMOTE POWER, END FEED

### LENGTH CHART Actual lengths for Cirrus Suspension R1

22K, 24K, 27K, 30K, 35K, 40K & 57K									
Ordering Code (Nominal Size)	Actual Length	2W (2.5 Watts)	Power Supply	5W (5 Watts)	Power Supply	Ordering Code (Nominal Size)	Actual Length	2W (2.5 Watts)	Power Supply
168	169.2	35	PSB-40W-UNI-24VDC	70	PSB-96W-UNI-24VDC	324	325.6	68	PSB-96W-UNI-24VDC
171	171.6	36	PSB-40W-UNI-24VDC	71	PSB-96W-UNI-24VDC	327	328.0	68	PSB-96W-UNI-24VDC
173	174.0	36	PSB-40W-UNI-24VDC	72	PSB-96W-UNI-24VDC	329	330.4	69	PSB-96W-UNI-24VDC
176	176.4	37	PSB-40W-UNI-24VDC	73	PSB-96W-UNI-24VDC	332	332.8	69	PSB-96W-UNI-24VDC
178	178.8	37	PSB-40W-UNI-24VDC	74	PSB-96W-UNI-24VDC	334	335.2	70	PSB-96W-UNI-24VDC
180	181.2	38	PSB-40W-UNI-24VDC	75	PSB-96W-UNI-24VDC	336	337.6	70	PSB-96W-UNI-24VDC
183	183.6	38	PSB-40W-UNI-24VDC	76	PSB-96W-UNI-24VDC	339	340.0	71	PSB-96W-UNI-24VDC
185	186.0	39	PSB-40W-UNI-24VDC	77	PSB-96W-UNI-24VDC	341	342.4	71	PSB-96W-UNI-24VDC
188	188.4	39	PSB-40W-UNI-24VDC	78	PSB-96W-UNI-24VDC	344	344.8	72	PSB-96W-UNI-24VDC
190	190.8	40	PSB-60W-UNI-24VDC	79	PSB-96W-UNI-24VDC	346	347.2	72	PSB-96W-UNI-24VDC
192	193.2	40	PSB-60W-UNI-24VDC	80	PSB-96W-UNI-24VDC	348	349.6	73	PSB-96W-UNI-24VDC
195	195.6	41	PSB-60W-UNI-24VDC	81	PSB-96W-UNI-24VDC	351	352.0	73	PSB-96W-UNI-24VDC
197	198.0	41	PSB-60W-UNI-24VDC	82	PSB-96W-UNI-24VDC	353	354.4	74	PSB-96W-UNI-24VDC
200	200.4	42	PSB-60W-UNI-24VDC	83	PSB-96W-UNI-24VDC	356	356.8	74	PSB-96W-UNI-24VDC
202	202.8	42	PSB-60W-UNI-24VDC	84	PSB-96W-UNI-24VDC	358	359.2	75	PSB-96W-UNI-24VDC
204	205.2	43	PSB-60W-UNI-24VDC	85	PSB-96W-UNI-24VDC	360	361.6	75	PSB-96W-UNI-24VDC
207	207.6	43	PSB-60W-UNI-24VDC	86	PSB-96W-UNI-24VDC	363	364.0	76	PSB-96W-UNI-24VDC
209	210.0	44	PSB-60W-UNI-24VDC	87	PSB-96W-UNI-24VDC	365	366.4	76	PSB-96W-UNI-24VDC
212	212.4	44	PSB-60W-UNI-24VDC	88	PSB-96W-UNI-24VDC	368	369.2	77	PSB-96W-UNI-24VDC
214	214.8	45	PSB-60W-UNI-24VDC	89	PSB-96W-UNI-24VDC	370	371.6	77	PSB-96W-UNI-24VDC
216	217.2	45	PSB-60W-UNI-24VDC	90	PSB-96W-UNI-24VDC	372	374.0	78	PSB-96W-UNI-24VDC
219	219.6	46	PSB-60W-UNI-24VDC	91	PSB-96W-UNI-24VDC	375	376.4	78	PSB-96W-UNI-24VDC
221	222.0	46	PSB-60W-UNI-24VDC	92	PSB-96W-UNI-24VDC	377	378.8	79	PSB-96W-UNI-24VDC
224	224.4	47	PSB-60W-UNI-24VDC	93	PSB-96W-UNI-24VDC	380	381.2	79	PSB-96W-UNI-24VDC
226	226.8	47	PSB-60W-UNI-24VDC	94	PSB-96W-UNI-24VDC	382	383.6	80	PSB-96W-UNI-24VDC
228	229.2	48	PSB-60W-UNI-24VDC	95	PSB-96W-UNI-24VDC	384	386.0	80	PSB-96W-UNI-24VDC
231	231.6	48	PSB-60W-UNI-24VDC	96	PSB-96W-UNI-24VDC	387	388.4	81	PSB-96W-UNI-24VDC
233	234.0	49	PSB-60W-UNI-24VDC	97	PSB-100W-ELV-24VDC	389	390.8	81	PSB-96W-UNI-24VDC
236	236.4	49	PSB-60W-UNI-24VDC	98	PSB-100W-ELV-24VDC	392	393.2	82	PSB-96W-UNI-24VDC
238	238.8	50	PSB-60W-UNI-24VDC	99	PSB-100W-ELV-24VDC	394	395.6	82	PSB-96W-UNI-24VDC
240	241.2	50	PSB-60W-UNI-24VDC	100	PSB-100W-ELV-24VDC	396	398.0	83	PSB-96W-UNI-24VDC
243	244.0	51	PSB-60W-UNI-24VDC			399	400.4	83	PSB-96W-UNI-24VDC
245	246.4	51	PSB-60W-UNI-24VDC			401	402.8	84	PSB-96W-UNI-24VDC
248	248.8	52	PSB-60W-UNI-24VDC			404	405.2	84	PSB-96W-UNI-24VDC
250	251.2	52	PSB-60W-UNI-24VDC			406	407.6	85	PSB-96W-UNI-24VDC
252	253.6	53	PSB-60W-UNI-24VDC			408	410.0	85	PSB-96W-UNI-24VDC
255	256.0	53	PSB-60W-UNI-24VDC			411	412.4	86	PSB-96W-UNI-24VDC
257	258.4	54	PSB-60W-UNI-24VDC			413	414.8	86	PSB-96W-UNI-24VDC
260	260.8	54	PSB-60W-UNI-24VDC			416	417.2	87	PSB-96W-UNI-24VDC
262	263.2	55	PSB-60W-UNI-24VDC			418	419.6	87	PSB-96W-UNI-24VDC
264	265.6	55	PSB-60W-UNI-24VDC			420	422.0	88	PSB-96W-UNI-24VDC
267	268.0	56	PSB-60W-UNI-24VDC						
269	270.4	56	PSB-60W-UNI-24VDC						
272	272.8	57	PSB-60W-UNI-24VDC						
274	275.2	57	PSB-60W-UNI-24VDC						
276	277.6	58	PSB-60W-UNI-24VDC						
279	280.0	58	PSB-60W-UNI-24VDC						
281	282.4	59	PSB-60W-UNI-24VDC						
284	284.8	59	PSB-60W-UNI-24VDC						
286	287.2	60	PSB-96W-UNI-24VDC						
288	289.6	60	PSB-96W-UNI-24VDC						
291	292.0	61	PSB-96W-UNI-24VDC						
293	294.4	61	PSB-96W-UNI-24VDC						
296	296.8	62	PSB-96W-UNI-24VDC						
298	299.2	62	PSB-96W-UNI-24VDC						
300	301.6	63	PSB-96W-UNI-24VDC						
303	304.0	63	PSB-96W-UNI-24VDC						
305	306.4	64	PSB-96W-UNI-24VDC						
308	308.8	64	PSB-96W-UNI-24VDC						
310	311.2	65	PSB-96W-UNI-24VDC						
312	313.6	65	PSB-96W-UNI-24VDC						
315	316.0	66	PSB-96W-UNI-24VDC						
317	318.4	66	PSB-96W-UNI-24VDC						
320	320.8	67	PSB-96W-UNI-24VDC						
322	323.2	67	PSB-96W-UNI-24VDC						

PROJECT		FIXTURE TYPE		DATE	
---------	--	--------------	--	------	--

# CIRRUS SUSPENSION R1

## RECTANGULAR R1 WITH REMOTE POWER, END FEED

### LAMP DATA Lamp Data for Cirrus Suspension R1

DESCRIPTION		CSR1																													
		DIFFUSED RECTANGULAR 1 LENS																													
WATTS PER FOOT		2W (2.5 watts)						5W (5 watts)						7W (7.5 watts)						10W (9.6 watts)											
COLOR TEMPERATURE		22K	24K	27K	30K	35K	40K	57K	22K	24K	27K	27D*	30K	27D*	35K	40K	57K	22K	24K	27K	30K	35K	40K	57K	22K	24K	27K	30K	35K	40K	57K
LUMENS PER FOOT (lm/ft)		123	136.5	150	164	187	204	217	239	265	291	329	318	359	364	396	422	379	420.5	462	505	579	629	670	448	497	546	597	683	743	791
LUMENS PER WATT (lm/w)		49	54.5	60	65	75	81	87	54	60	66	75	72	82	83	90	96	52	57.5	63	69	79	86	92	47	52	57	62	71	77	82
CRI		85+	90+	95+	95+	85+	84	84	85+	90+	95+	95+	95+	95+	85+	84	84	85+	90+	95+	95+	85+	84	84	85+	90+	95+	95+	85+	84	84

\*27D, 30D - Warm Dim (4.8 Watts)

### 8', 140° AT 3000K

2 Watt 140°	
Distance	Foot Candles
1'	69
1.5'	46
2'	35
3'	23
4'	16
5'	12
6'	10
7'	8
8'	7

5 Watt 140°	
Distance	Foot Candles
1'	111
1.5'	75
2'	56
3'	37
4'	27
5'	20
6'	16
7'	13
8'	11

7 Watt 140°	
Distance	Foot Candles
1'	180
1.5'	120
2'	90
3'	60
4'	43
5'	33
6'	26
7'	21
8'	18

10 Watt 140°	
Distance	Foot Candles
1'	191
1.5'	127
2'	95
3'	62
4'	45
5'	34
6'	27
7'	21
8'	19

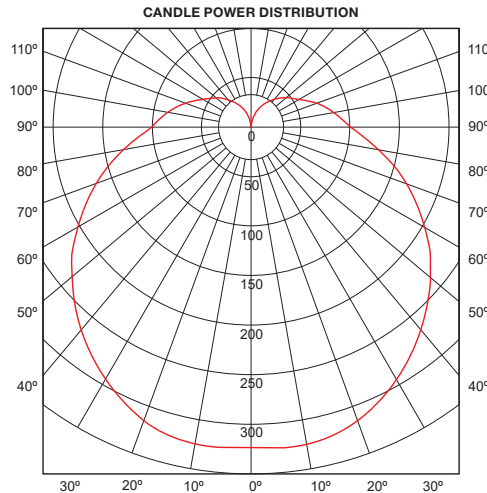
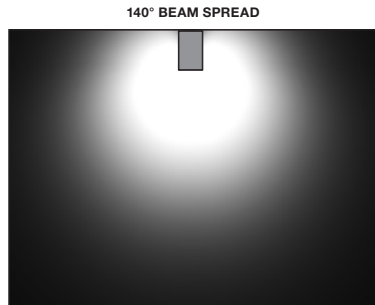

DIFFUSED WHITE LENS

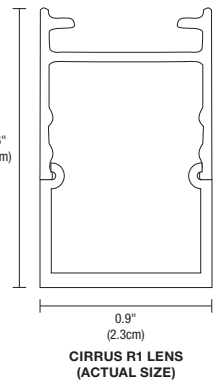

PROJECT	FIXTURE TYPE	DATE
---------	--------------	------

# CIRRUS SUSPENSION R1

## RECTANGULAR R1 WITH REMOTE POWER, END FEED

### DRAWINGS Canopy & Channel drawings for Cirrus Suspension R1

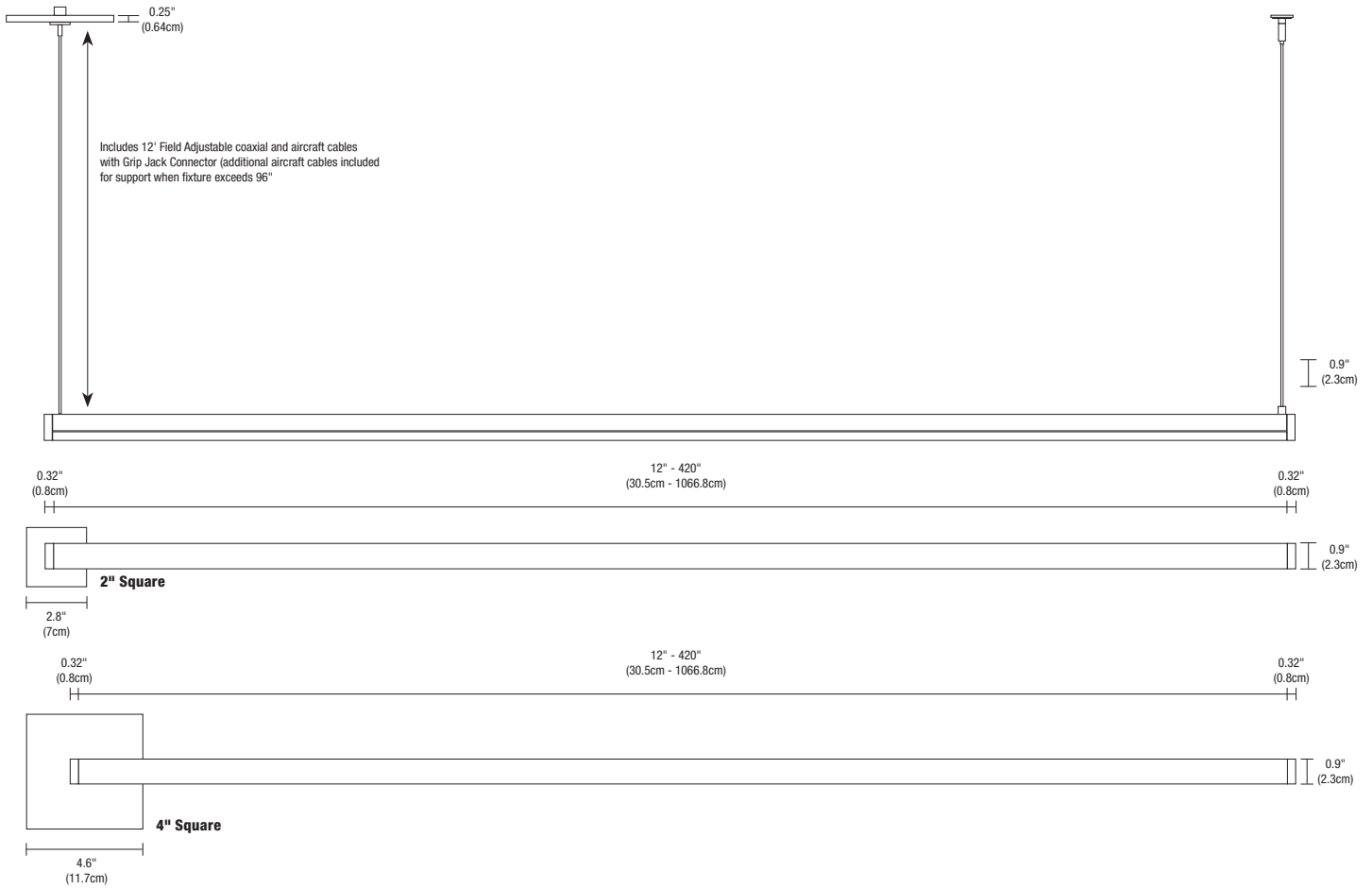

PROJECT		FIXTURE TYPE		DATE	
---------	--	--------------	--	------	--

# CIRRUS SUSPENSION R1

## RECTANGULAR R1 WITH REMOTE POWER, END FEED

**DRAWINGS** Side-View shown with two 2" and 4" Canopies; one for Remote Power, one Blank

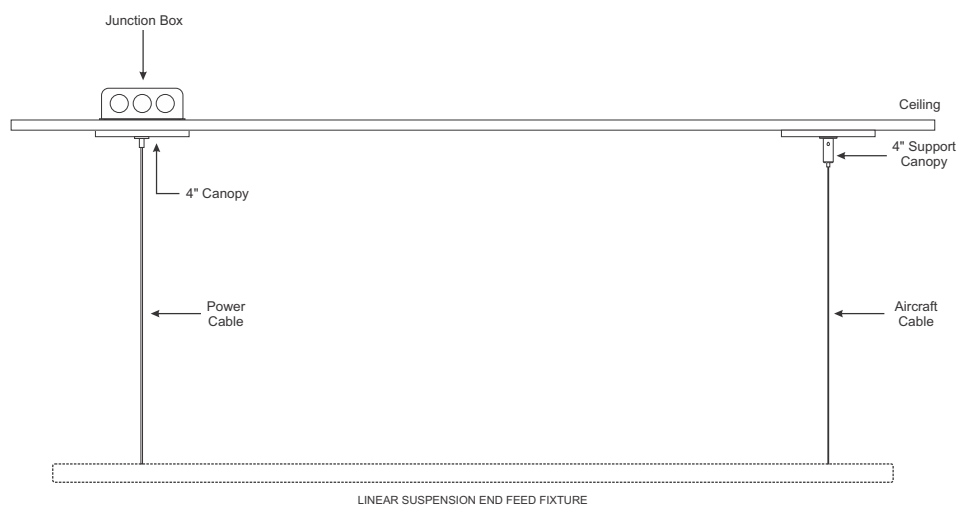
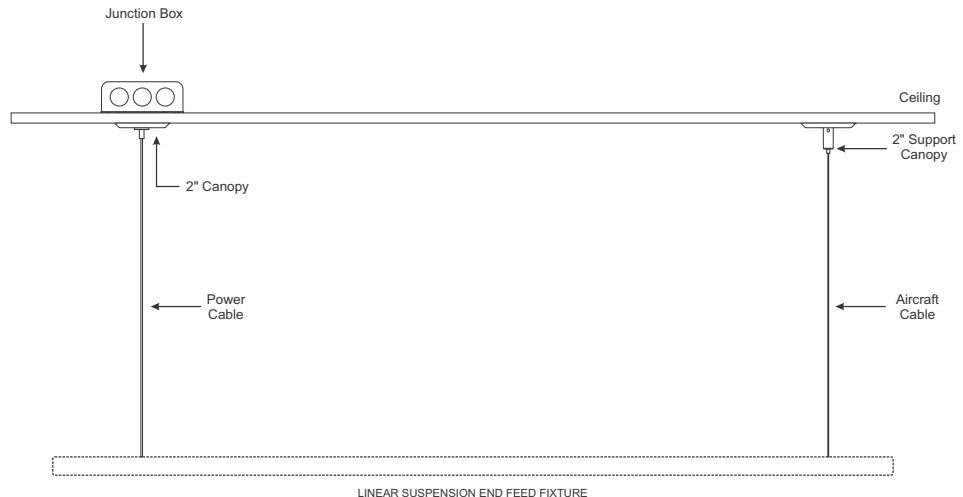
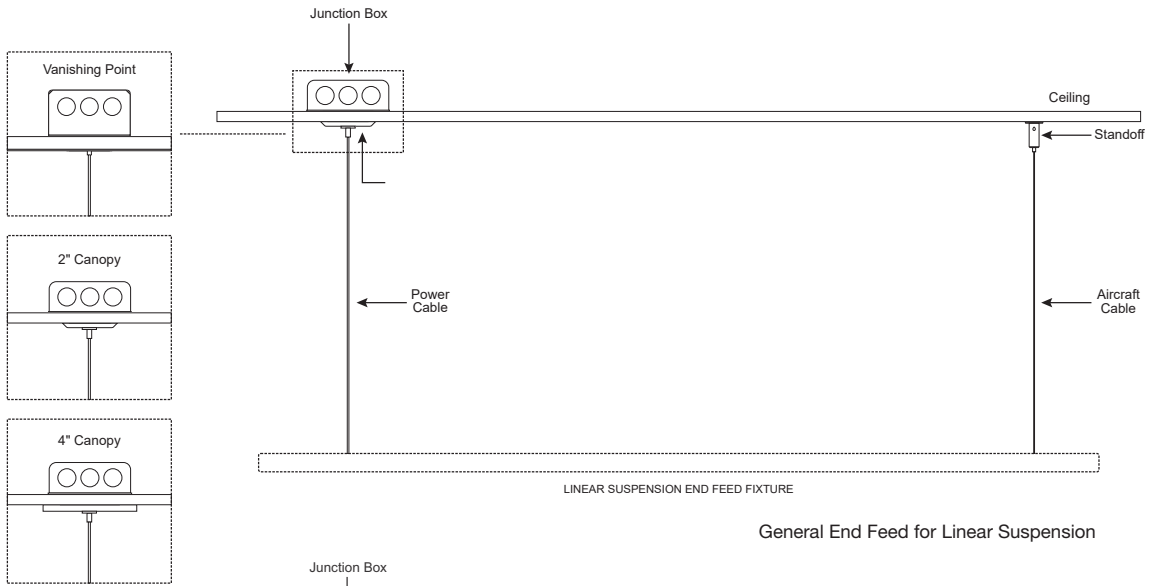

PROJECT	FIXTURE TYPE	DATE
---------	--------------	------

**COMPONENTS** Swag Bar & Hook, Swag Hook, and T-Bar are compatible with all Power Canopy options and may be required based on lighting design and application

### NEW CONSTRUCTION & REMODEL 2" COVER FOR 4" SQUARE JUNCTION BOX

The New Construction NC2-JBOX Cover is included with the 2" Round and Square Canopies and is not required for the 4" Square Canopies. NC2 New Construction Junction Box Cover mounts to a standard 4" Electrical Box or Octagon Box, converting it to a 2" Plaster Ring for use with the 2R (Round) or 2S (Square) Canopy. The Remodel RM2-JBOX Plaster Plate cover is used with an existing 4" Square Junction Box and standard Round Plaster Ring. The PS-60L-ELV-24VDC (50 Watt IC, 60 Watt Non-IC) will fit inside the NC2 or RM2-JBOX Cover and Electrical Junction Box for a flush look.

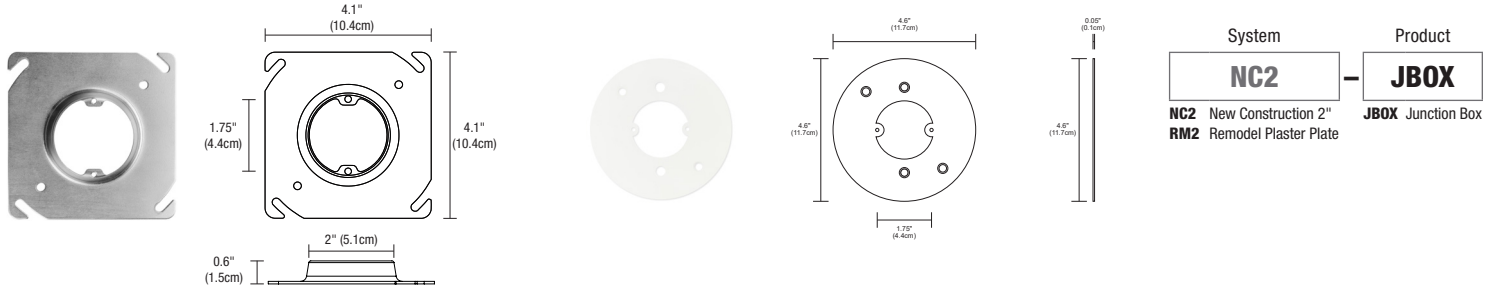

### CIRRUS REMOTE POWER CANOPIES (INCLUDED)

Canopies are included with Canopy ordering code. The 2" Round and Square Canopy includes a special Plaster Ring NC2-JBOX (above). The 4" Square or Round Canopy fits on a standard 4" Electrical Box with Round Plaster Ring and the PS-60L-ELV-24VDC 50 Watt IC, 60 Watt Non-IC) will fit inside the NC2 or RM2-JBOX Cover and Electrical Junction Box for a flush look. Vanishing Point Plaster in system with No Canopy, only see cable going through drywall ceiling with GJ24.

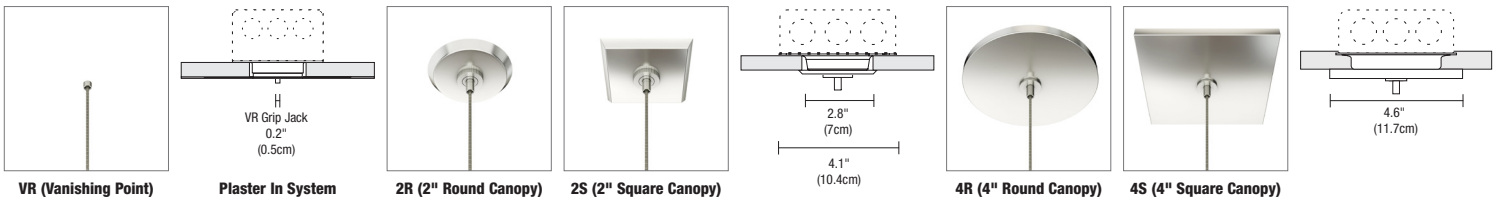

2 inch or 4 inch Canopy (Not Included)

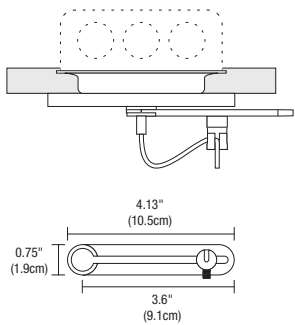

### CHANNEL SUSPENSION ADJUSTABLE SWAG BAR AND HOOK

Channel Suspension Adjustable Swag Bar and Hook allows a cable to form a straight connection to the channel when the Power Canopy is not located directly above the fixture. Use when you have two or more canopies (power supplies) on the same fixture run. The Adjustable Swag Hook is compatible with the 2R, 2S, 4R and 4S Power Canopies (Canopy not included).

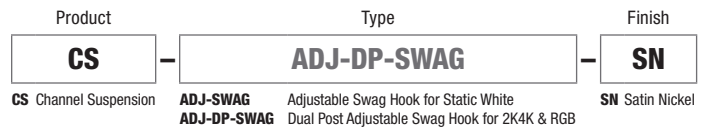

### CHANNEL SUSPENSION SWAG HOOK

The clear plastic Swag Hook extends a cable from an electrical box that is not located directly above desired fixture location.

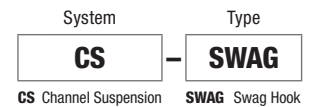
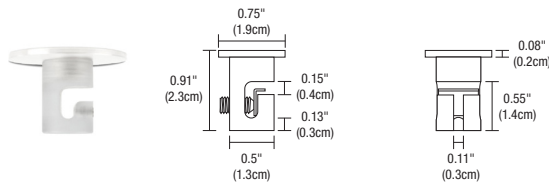

### CHANNEL SUSPENSION ADJUSTABLE T-BAR CLIP

Channel Suspension Adjustable T-Bar Clip mounts to T-Bar grid ceilings. Available in Satin Nickel Hardware as Adjustable Power and Non-Power versions.

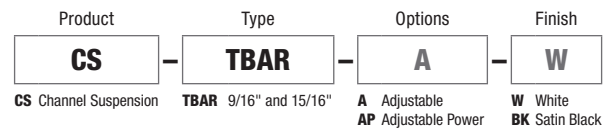
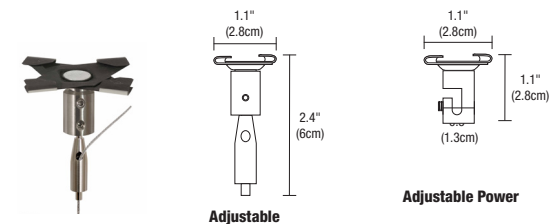

PROJECT	FIXTURE TYPE	DATE
---------	--------------	------

# CIRRUS SUSPENSION R1

## RECTANGULAR R1 WITH REMOTE POWER, END FEED

**DRAWINGS** Side-View shown with two 2" and 4" Canopies; one for Remote Power, one Blank

**Cirrus Suspension Downlight with Remote Power 4R2, 4S2, 4" Canopy Shown**

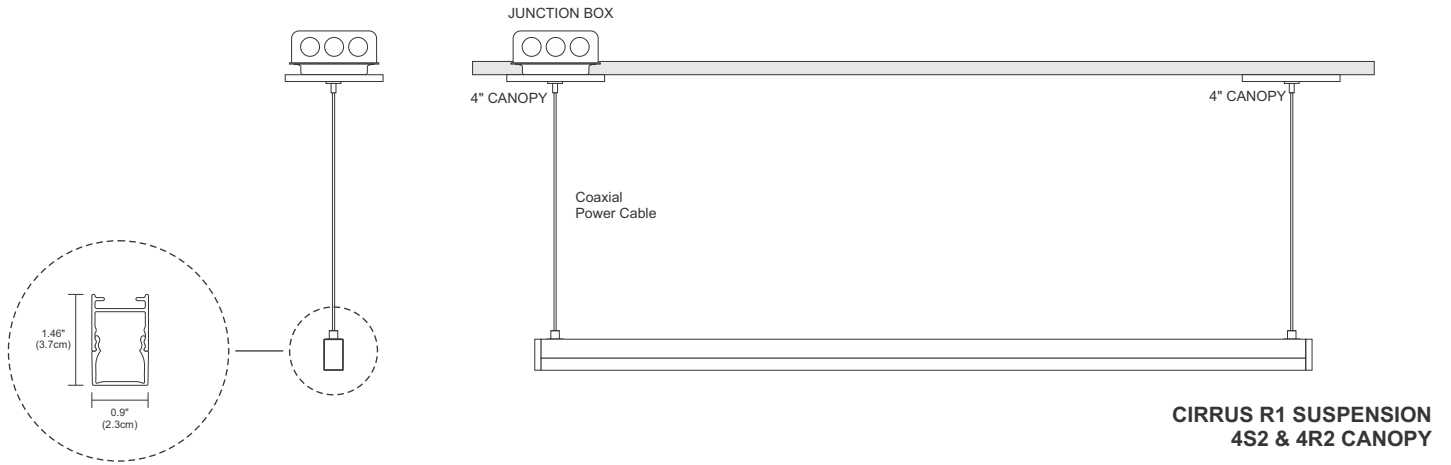

**Cirrus Suspension Downlight with Remote Power 2R2, 2S2, 2" Canopy Shown**

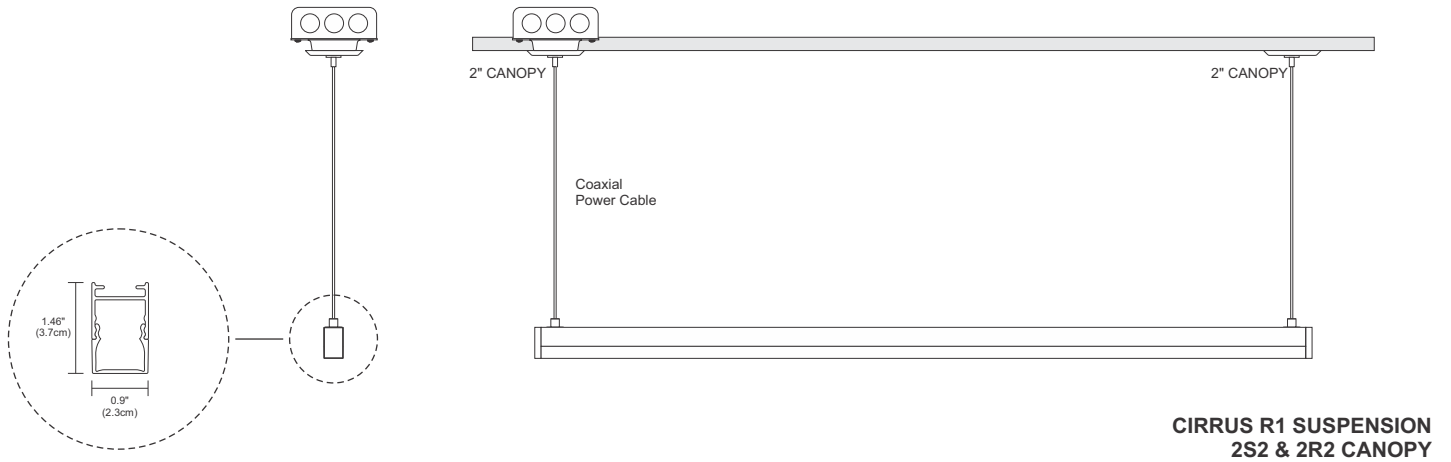

PROJECT		FIXTURE TYPE		DATE	
---------	--	--------------	--	------	--



### WIRING DIAGRAM Wiring Diagram for Static White with ELV Dimmer

#### APPLICATION

ELV dimming for Cirrus R1 Suspension, End Feed Canopy, Static White

#### REMOTE POWER SUPPLIES

Class 2: 24VDC output; 120VAC input | PS-60L-ELV-24VDC (fits in J-box) | PSB-60W-ELV-24VDC  
PSB-100W-ELV-24VDC

#### DIMMING

Dimmable with ELV dimmer: Legrand, Adorne ADTP703TU  
Lutron: Diva DVELV-300P, Skylark SELV-300P, Maestro MAELV-600 and Radio Ra 2

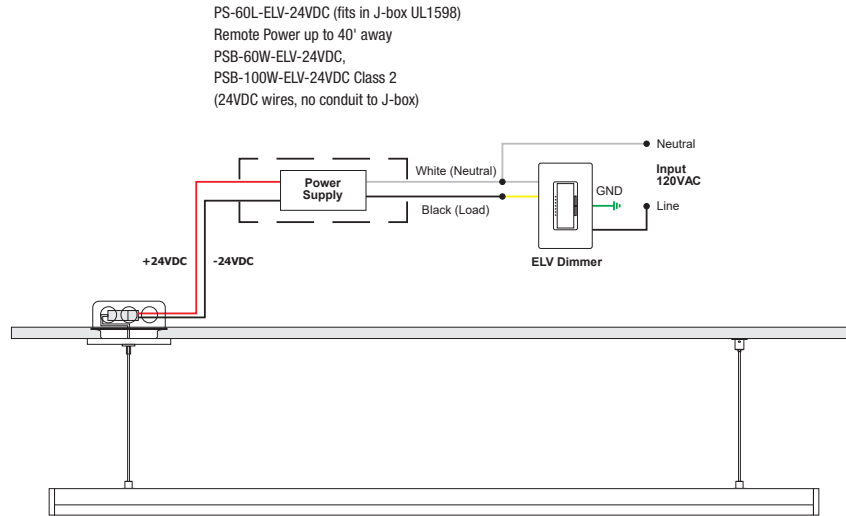

### WIRING DIAGRAM Wiring Diagram for Static White with 0-10V Dimmer

#### APPLICATION

0-10V dimming for Cirrus R1 Suspension, End Feed Canopy, Static White

#### REMOTE POWER SUPPLIES

Class 2: 24VDC output; 120/277VAC input | PSB-60W-010-24VDC | PSB-100W-010-24VDC

#### DIMMING

Dimmable with 0-10V dimmer: Philips: Sunrise SR1200ZTUNV; Lutron: Diva DVTV-WH, Nova-T NTSTV-DV-XX, Grafix Eye QS QSGRJ-XP, Radio RA2 RRD-1-ND; Leviton: IP710-DLZ, LEV40050, IP710-LFZ; Legrand ADPD4FBL3P2W4

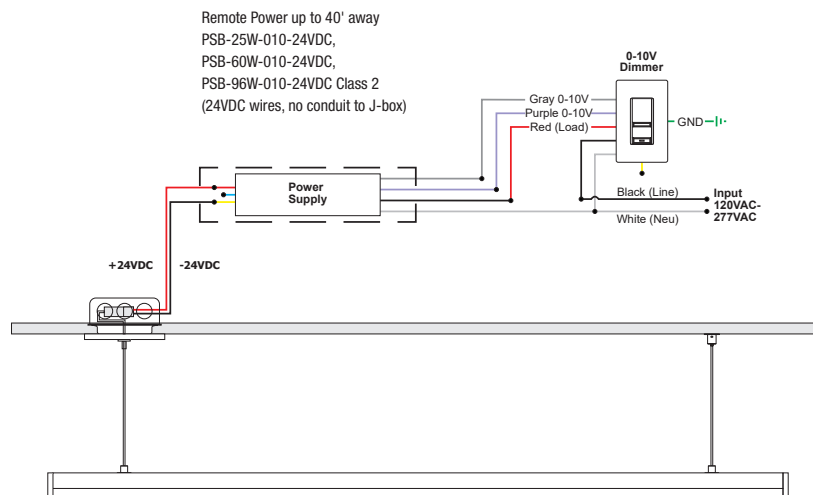

PROJECT	FIXTURE TYPE	DATE
---------	--------------	------



**IN WALL MOUNTING OPTIONS**

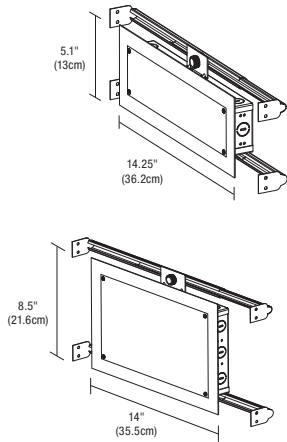

**In-Wall Mounting Kit:** Includes power supply, box cover and stud hangers for installing Junction Box in wall. Select "IW" in the options section of compatible power supply ordering codes if an In-Wall Mounting Kit is needed.

**Ordering Codes 5.1 x 14.25 inch:** PSB-40W-UNI-24VDC-IW  
PSB-60W-UNI-24VDC-IW  
PSB-96W-UNI-24VDC-IW

**Ordering Codes 8.5 x 14.25 inch:** PSB-2X40W-UNI-24VDC-IW  
PSB-2X60W-UNI-24VDC-IW  
PSB-2X96W-UNI-24VDC-IW

**WIRING DIAGRAMS UNIVERSAL POWER SUPPLY**

**Application:** ELV dimming for Static White and Warm Dim

**Dimming:** Dimmable with ELV dimmer: Legrand, Adorne ADTP703TU; Lutron: Diva DVELV-300P, Skylark SELV-300P, Maestro MAELV-600 and Radio Ra 2

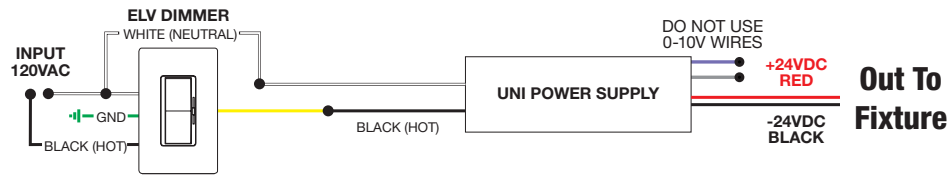

**Application:** 0-10V dimming for Static White

**Dimming:** Dimmable with 0-10V dimmer: Philips Sunrise: SR1200ZTUNV; Lutron Diva: DVTV-WH, DVSTV-WH; Lutron Nova T: NTSTV-DV-XX; Lutron Grafix EYE QS: QSGRJ-XP; Lutron Radio Ra2: RRD-10ND; Leviton: LEV40050; Leviton IP710-LFZ; Legrand: ADPD4FBL3P2W4

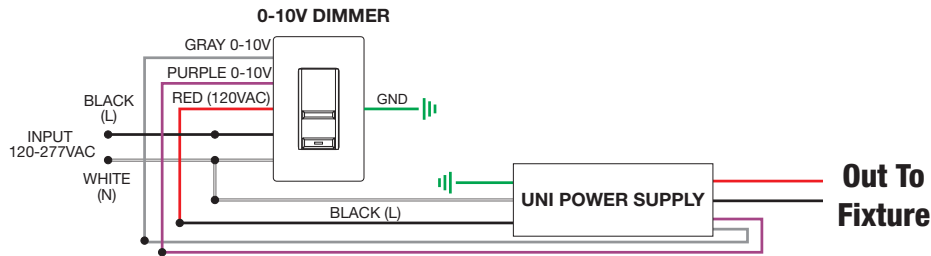

**Application:** Triac dimming for two power supplies, use for Static White and Warm Dim

**Dimming:** Dimmable with Triac dimmer: Lutron: Skylark S2-L

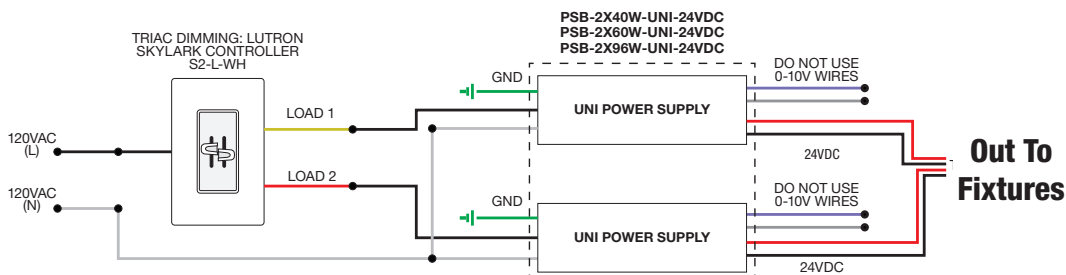

PROJECT		FIXTURE TYPE		DATE	
---------	--	--------------	--	------	--

LUTRON HI-LUME® PREMIER .1% ECOSYSTEM®†			
ORDERING CODES	L3D0-96W24V-U	2-WIRE ECOSYSTEM LTEA4U1UKL-CV240	3-WIRE ECOSYSTEM L3DA4U1UKL-CV240
SPECIFICATIONS			
MAXIMUM LOAD	96W	5W-40W	5W-40W
INPUT VOLTAGE	120-277VAC	120-277VAC	120-277VAC
OUTPUT VOLTAGE	24VDC	24VDC	24VDC
DIMENSIONS	10.5" X 5.5" X 2"	4" X 4.89" X 2.62"	4" X 4.89" X 2.62"
CLASSIFICATION	CLASS 2	CLASS 2	CLASS 2
DIMMING AND CONTROLS			
RADIO RA2	•	•	•
HOMEWORKS QS	•	•	•
PHPM-3F-120	•	•	•
PHPM-3F-DV	•	•	•
BCI-0-10	•	•	•

†24K - 57K color temperatures are compatible with 0-10V, ELV, and Lutron Hi-lume® Power Supplies. Warm Dim (27D, 30D) color temperatures are only compatible with ELV power supplies.

2-Wire EcoSystem Wiring Diagram

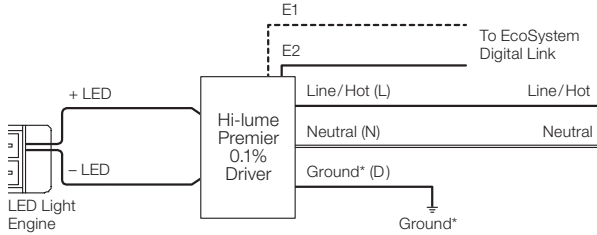

LTEA4U1UKL-CV240

3-Wire Wiring Diagram

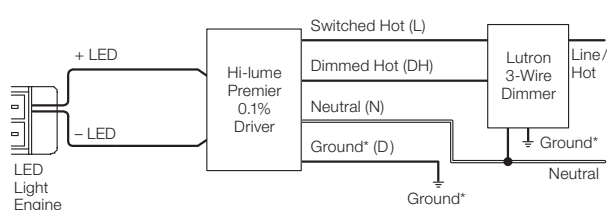

L3DA4U1UKL-CV240

PROJECT	FIXTURE TYPE	DATE
---------	--------------	------

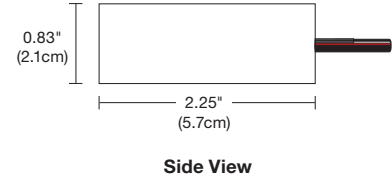
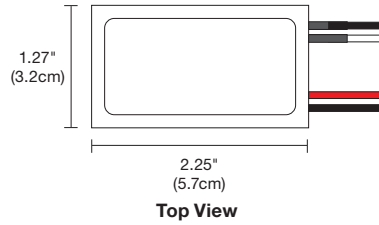
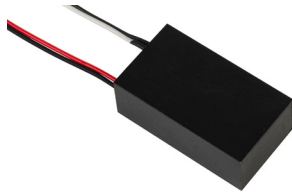

**DESCRIPTION**

Compact, lightweight remote electronic 60W/24V LED Power Supply\* converts standard 120VAC voltage to 24VDC and features built-in short-circuit protection. The low voltage output may be dimmed using an electronic low voltage dimmer. The Power Supply is certified to be used inside a standard Junction Box enclosure. Power Supply features short circuit and overload protection. Indoor applications only.

*\*Electrical Panels using Siemens/Murray AFCI breakers are not compatible with this ELV transformer. Use 0-10 Volt power supplies with this breaker.*

**APPLICATIONS**

Indoor\*

To avoid overheating the power supply, install it in a ventilated remote location where air flows. Maintain proper spacing among power supplies when multiple power supplies are installed in the same remote location.

- POWER INPUT** 120 volts AC, 60Hz
- POWER OUTPUT** Class 2; 24 volts DC 2.5A 60 watt maximum
- DIMENSIONS** 2.25" x 1.25" x 0.83"
- DIMMER TYPE** Electronic Low Voltage Dimmer Lutron: Diva #DVELV-300P; Skylark #SELV-300P; Maestro #MAELV-600

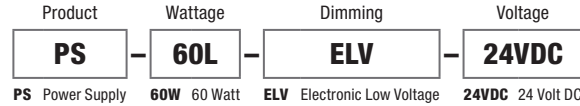
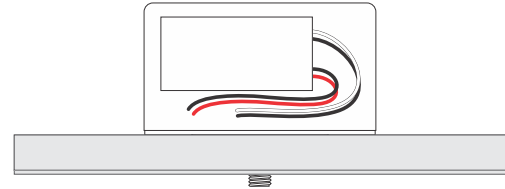

**SAMPLE WIRING DIAGRAMS 24VDC ELV**

**Application:** ELV dimming for Static White

**Dimming:** Dimmable with ELV dimmer: Legrand, Adorne ADTP703TU; Lutron: Diva DVELV-300P, Skylark SELV-300P, Maestro MAELV-600 and Radio Ra 2

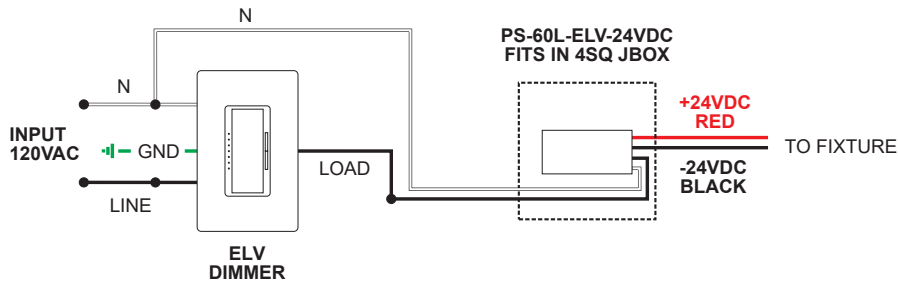

**Application:** Dual ELV dimming for Dynamic/Tunable White 2000K-4000K

**Dimming:** Dimmable with ELV dimmer: Legrand, Adorne ADTP703TU; Lutron: Diva DVELV-300P, Skylark SELV-300P, Maestro MAELV-600 and Radio Ra 2

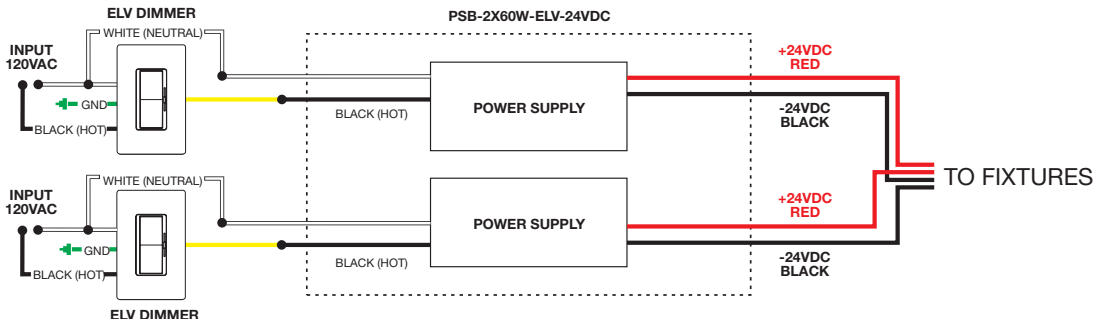

PROJECT	FIXTURE TYPE	DATE
---------	--------------	------

# SUSPENSION TM30 DATA

## RECTANGULAR R1 WITH REMOTE POWER, END FEED

**TM-30-15 DATA:** The data below is for SS2C, SS5C, SS7C, and SS10C bare LED Soft Strips. Consistent color temperatures throughout a single strip and among multiple strips is possible through a 3 phase binning process in which each order is inspected with a color meter to ensure uniformity.

**2200K** | Rf: 83.9 | Rg: 94.9  
Color Vector Graphic

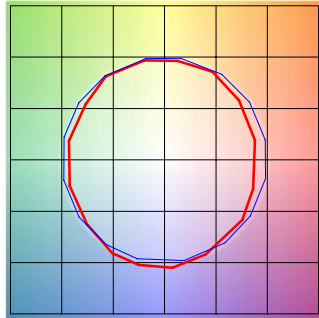

■ Test ■ Reference

		GRAPHIC SHIFTS %	
HUE BIN	Rf	CHROMA	HUE
1	77.6	-10.0%	1.8%
2	80.7	-7.5%	7.0%
3	79.5	-2.9%	8.9%
4	90.5	-3.1%	2.4%
5	93.9	-1.3%	1.9%
6	91.9	-0.9%	-0.2%
7	87.6	-6.3%	-2.7%
8	90.5	-5.4%	2.7%
9	83.8	-4.7%	6.5%
10	81.2	-2.5%	10.0%
11	83.3	3.9%	9.4%
12	86.4	5.6%	2.6%
13	86.2	4.5%	-12.4%
14	64.3	-1.0%	-21.9%
15	85.1	-4.4%	-7.5%
16	75.0	-9.9%	-12.0%

**2400K** | Rf: 91.2 | Rg: 96.8  
Color Vector Graphic

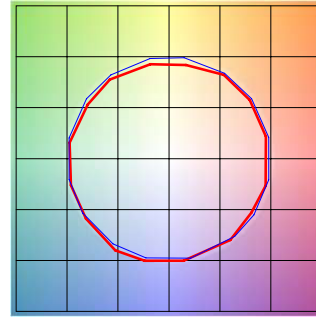

■ Test ■ Reference

		GRAPHIC SHIFTS %	
HUE BIN	Rf	CHROMA	HUE
1	92.0	-2.4%	1.5%
2	94.7	-2.1%	0.0%
3	95.4	-1.9%	-0.1%
4	88.7	-6.7%	-3.1%
5	92.8	-5.6%	1.0%
6	92.7	-3.4%	3.4%
7	89.9	-4.3%	4.1%
8	92.4	-1.4%	4.4%
9	89.0	-0.6%	5.8%
10	88.9	0.4%	6.2%
11	89.7	4.0%	5.4%
12	92.6	3.0%	-0.7%
13	90.9	1.1%	-7.0%
14	89.9	0.5%	-5.8%
15	92.1	-3.2%	0.1%
16	88.9	-1.7%	-6.3%

**2700K** | Rf: 87.7 | Rg: 96.1  
Color Vector Graphic

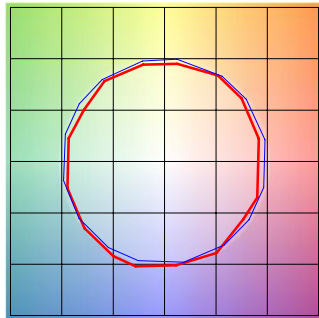

■ Test ■ Reference

		GRAPHIC SHIFTS %	
HUE BIN	Rf	CHROMA	HUE
1	86.4	-5.6%	2.3%
2	89.7	-3.3%	3.1%
3	90.5	-1.5%	3.8%
4	90.0	-4.3%	1.1%
5	92.9	-3.7%	0.2%
6	93.5	-2.5%	-0.8%
7	86.3	-7.2%	2.5%
8	90.7	-4.0%	3.2%
9	85.2	-2.4%	8.1%
10	81.7	0.9%	10.8%
11	85.4	4.5%	8.9%
12	88.7	5.7%	-1.4%
13	88.3	1.3%	-7.9%
14	85.1	2.4%	-10.4%
15	88.1	-4.8%	-2.7%
16	81.7	-4.3%	-10.9%

**3000K** | Rf: 88.1 | Rg: 99.7  
Color Vector Graphic

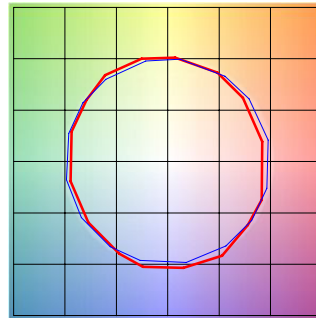

■ Test ■ Reference

		GRAPHIC SHIFTS %	
HUE BIN	Rf	CHROMA	HUE
1	87.7	-5.9%	-0.3%
2	87.9	-4.4%	4.3%
3	82.9	-1.2%	7.9%
4	89.9	0.6%	4.7%
5	92.7	3.0%	3.5%
6	92.7	3.6%	-1.7%
7	90.8	-1.3%	-4.4%
8	93.7	-2.5%	-2.2%
9	91.7	-3.7%	2.3%
10	85.5	-2.8%	7.8%
11	83.3	0.7%	11.0%
12	86.4	5.5%	3.8%
13	90.6	4.6%	-3.6%
14	85.6	5.9%	-8.4%
15	89.5	-0.6%	-5.7%
16	82.6	-2.7%	-12.0%

**3500K** | Rf: 86.1 | Rg: 95.5  
Color Vector Graphic

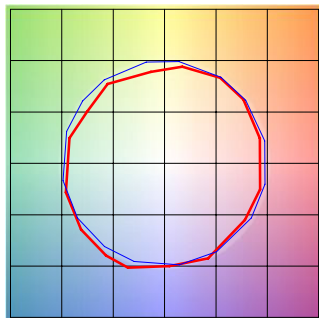

■ Test ■ Reference

		GRAPHIC SHIFTS %	
HUE BIN	Rf	CHROMA	HUE
1	86.6	-4.2%	3.4%
2	91.7	-1.4%	1.8%
3	94.9	-0.7%	0.4%
4	87.9	-4.5%	-4.1%
5	85.9	-10.3%	-2.7%
6	89.8	-5.2%	-0.4%
7	79.6	-9.5%	6.5%
8	87.6	-4.0%	5.7%
9	81.4	-0.5%	11.8%
10	78.3	3.3%	11.4%
11	85.7	6.3%	6.1%
12	86.3	7.1%	-4.6%
13	86.1	-0.7%	-9.6%
14	85.1	0.8%	-10.4%
15	83.4	-4.1%	-5.3%
16	82.5	-3.6%	-5.7%

**4000K** | Rf: 87.6 | Rg: 96.8  
Color Vector Graphic

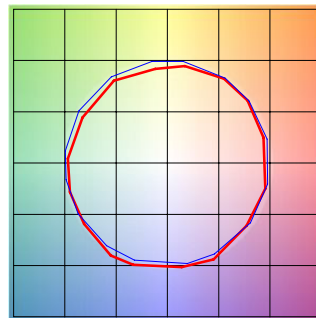

■ Test ■ Reference

		GRAPHIC SHIFTS %	
HUE BIN	Rf	CHROMA	HUE
1	89.0	-3.1%	2.1%
2	93.2	-0.9%	1.3%
3	94.3	-1.1%	0.7%
4	89.5	-4.0%	-2.3%
5	87.6	-7.8%	-1.8%
6	92.2	-4.6%	0.1%
7	87.4	-6.6%	3.6%
8	85.7	-3.8%	7.0%
9	81.5	-1.3%	12.4%
10	80.0	0.9%	11.4%
11	83.3	5.9%	8.7%
12	89.7	4.8%	-0.3%
13	88.5	2.4%	-6.3%
14	92.7	4.0%	-3.8%
15	86.1	-1.6%	-4.5%
16	85.0	-1.4%	-5.0%

PROJECT	FIXTURE TYPE	DATE
---------	--------------	------

# SUSPENSION TM30 DATA

## RECTANGULAR R1 WITH REMOTE POWER, END FEED

**TM-30-15 DATA:** The data below is for SS2C, SS5C, SS7C, and SS10C bare LED Soft Strips. Consistent color temperatures throughout a single strip and among multiple strips is possible through a 3 phase binning process in which each order is inspected with a color meter to ensure uniformity.

**5700K** | Rf: 80.3 | Rg: 91.5

Color Vector Graphic

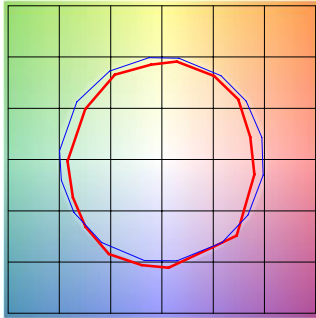

■ Test ■ Reference

HUE BIN	Rf	GRAPHIC SHIFTS %	
		CHROMA	HUE
1	73.8	-11.2%	2.6%
2	83.7	-5.5%	5.8%
3	84.2	-4.0%	5.5%
4	85.8	-3.5%	1.3%
5	85.3	-7.1%	0.6%
6	89.2	-5.8%	-2.2%
7	81.5	-10.7%	1.2%
8	75.7	-9.7%	8.5%
9	74.9	-7.8%	18.8%
10	67.8	-1.6%	18.0%
11	76.1	5.5%	12.0%
12	90.8	4.9%	-1.6%
13	83.6	5.0%	-9.5%
14	81.7	-1.2%	-10.0%
15	69.0	2.0%	-22.8%
16	83.2	-8.5%	-1.0%

**2700D** | Rf: 89.5 | Rg: 100.8

Color Vector Graphic

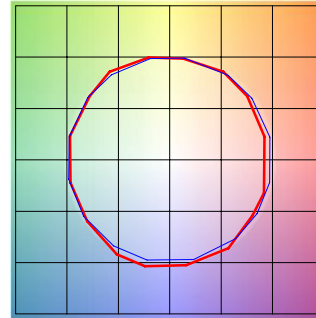

■ Test ■ Reference

HUE BIN	Rf	GRAPHIC SHIFTS %	
		CHROMA	HUE
1	88.8	-5.1%	1.4%
2	89.8	-2.7%	4.1%
3	87.2	0.3%	5.9%
4	92.3	-0.9%	1.0%
5	93.3	1.5%	1.7%
6	92.4	3.6%	-0.2%
7	92.2	-0.9%	-2.4%
8	96.7	-0.4%	-1.1%
9	92.3	-1.2%	3.7%
10	88.9	-0.0%	6.1%
11	86.4	5.1%	7.4%
12	88.2	6.3%	-0.9%
13	87.2	3.8%	-8.1%
14	84.2	3.8%	-11.0%
15	89.8	-2.6%	-4.3%
16	82.7	-3.4%	-11.1%

**3000D** | Rf: 89.8 | Rg: 101.4

Color Vector Graphic

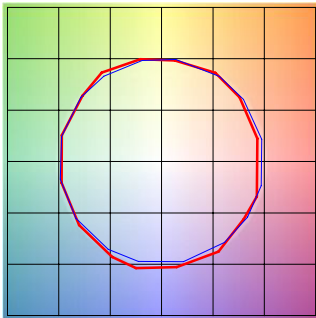

■ Test ■ Reference

HUE BIN	Rf	GRAPHIC SHIFTS %	
		CHROMA	HUE
1	90.2	-4.2%	1.5%
2	90.9	-2.0%	3.7%
3	87.9	0.8%	5.5%
4	92.1	-0.9%	0.6%
5	93.0	1.5%	1.6%
6	92.2	3.9%	-0.2%
7	92.1	-0.3%	-2.0%
8	96.7	0.0%	-1.2%
9	92.5	-0.6%	3.7%
10	88.3	1.1%	7.0%
11	87.2	4.1%	7.4%
12	87.2	6.7%	-1.0%
13	88.2	3.8%	-7.2%
14	85.3	4.3%	-9.9%
15	90.9	-2.2%	-3.6%
16	83.4	-2.2%	-11.2%

PROJECT	FIXTURE TYPE	DATE
---------	--------------	------