

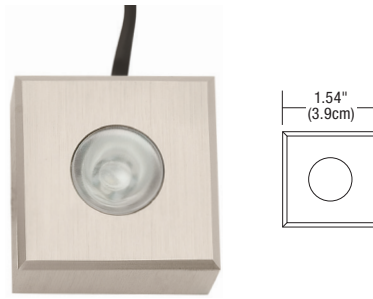

**DOT-RD-1W-30D-30K-SA**



**DOT-SQ-1W-30D-30K-SA**



**DOT-RD-1W-90D-30K-SA**

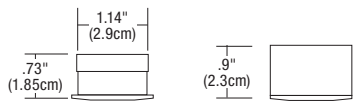

**RECESSED**

**SURFACE**

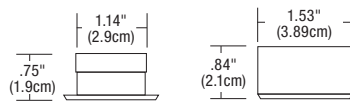

**RECESSED**

**SURFACE**

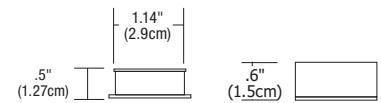

**RECESSED**

**SURFACE**



**REMOVE COLLAR FOR RECESSED MOUNTING**

**DESCRIPTION**

Recessed or Surface Mount (using Surface Mount Collar provided), the Dot LED features solid aluminum construction and uses only 1 watt of Warm White LED light. Ideal for cabinet illumination, the tiny but powerful Round or Square fixture provides a 30° beam spread. Round version is also available with a 90° beam spread. Includes 8' Cord/Plug Port, Wire Clips, and Screws. Fixture plugs into an 8-port hub, which distributes the low voltage power from LED power source. Fixtures use 12VAC power supplies and include 5 year warranty. For custom quotes and layout assistance, send your drawings and ideas to our design team: [design@PureEdgeLighting.com](mailto:design@PureEdgeLighting.com).

**FINISH**

Satin Aluminum or Bronze

**LAMPING**

1 Watt, 64 Total Lumens (90°), 61 Total Lumens (30°), 12VAC or DC LED, 3000K, 80+ CRI, 70% Lumen Maintenance based on 50,000 Hours of Operation

**DIMMING**

Dimmable with Lutron Diva or Skylark Standard Electronic Low Voltage Dimmers, AC Power Supplies dim down to 20% before flickering and slight buzzing

**POWER SUPPLY**

- Hardwired: TE-60L-12
- Plug-In: TE-60L-12AC-P

**WEIGHT**

0.5 lbs (0.23 kg)

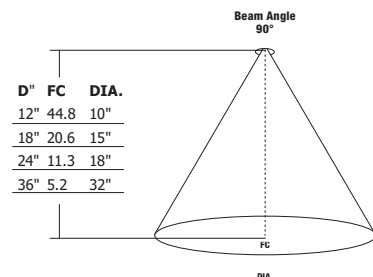
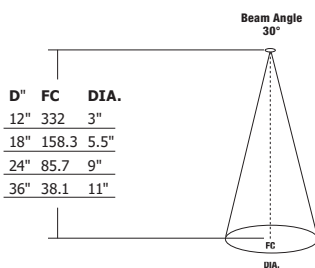

D - Distance from DOT LED fixture  
FC - Initial footcandles at the center of beam  
DIA - Diameter

Product	Type	Wattage	Beam Spread	Color Temperature	Finish
<b>DOT</b>	<b>RD</b>	<b>1W</b>	<b>30D</b>	<b>30K</b>	<b>SA</b>
DOT Dot LED	RD Round SQ Square	1W 1 Watt	30D 30° 90D 90° (Round only)	30K 3000K Warm White	SA Satin Aluminum BZ Bronze

PROJECT	FIXTURE TYPE	DATE
---------	--------------	------

**ACCESSORIES** Power hub for Dots & Pucks

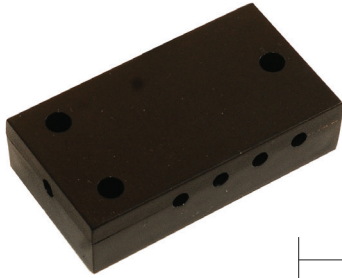

6' CORD CONNECTS TO LED POWER SOURCE

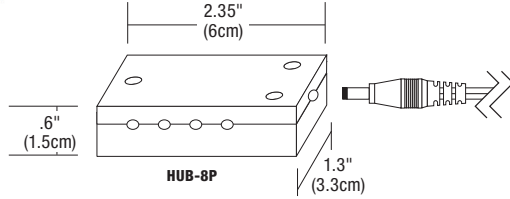

**8-PORT HUB**

The 8-Port Hub distributes the 12V AC/DC low voltage power from LED transformer to a combination of 1-8 LED Puck or Dot lights. Includes 6' Power Feed Connector Cord and three Clips.

Product	Type
<b>HUB</b>	<b>8P</b>
HUB Power Hub	8P 8-Port

**12' HUB EXTENSION CORD & HUB CONNECTOR**

The 12' Extension Cord extends the Hub Power Cord or the Puck and Dot fixture cord. Includes six pieces of WC-1 Wire Clips. Use HUB-HUB-12 to link multiple Hubs together.



Product	Type	Length
<b>HUB</b>	<b>EC</b>	<b>12</b>
HUB Power Hub	EC Extension Cord HUB Hub to Hub	12 12'

**WIRE CLIPS**

Wire Clips keep wires organized. Secure with screws or double-sided tape (included). Three Wire Clips provided for each fixture. Also sold separately.

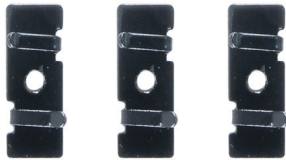

Product	Type
<b>WC</b>	<b>1</b>
WC Wire Clip	1 Standard

PROJECT		FIXTURE TYPE		DATE	
---------	--	--------------	--	------	--

**ACCESSORIES AC Power for Dots & Pucks**



**ELECTRONIC 60 WATT AC TRANSFORMER WITH RECTANGLE CANOPY COVER**

TE-60L-12 Electronic 60 Watt, 12 Volt AC Hard Wire fits inside Single Gang Electrical Box covered with a White 3" Rectangular Canopy powering the Dots and Pucks.

Product	Wattage	Voltage	Type	Finish
<b>TE</b>	<b>60L</b>	<b>12AC</b>	<b>3RE</b>	<b>WH</b>
TE Transformer Electronic	60L 60 Watt LED	12AC 12 Volt AC	3RE 3" Rectangle Canopy Cover	WH White



**ELECTRONIC 60 WATT LED AC TRANSFORMER PLUG-IN**

Plug-In version of the TE-60-12 Electronic 60 Watt, 12 Volt AC Transformer includes 10' of Cord and DC Connector to plug into the HUB-8P powering the Dots and Pucks.

Product	Wattage	Voltage	Type
<b>TE</b>	<b>60L</b>	<b>12AC</b>	<b>P</b>
TE Transformer Electronic	60L 60 Watt LED	12AC 12 Volt AC	P Plug-In



**ELECTRONIC 60 WATT LED AC TRANSFORMER**

TE-60L-12 Electronic 60 Watt, 12 Volt AC Transformer converts standard 120 Volt line voltage to 12 Volts and features built-in short-circuit protection. Fits inside an Electrical Junction Box. Minimum dimming load is 6 Watts.

Product	Wattage	Voltage
<b>TE</b>	<b>60L</b>	<b>12</b>
TE Transformer Electronic	60L 60 Watt LED and Halogen	12 12 Volt AC



**3" RECTANGLE & 4" ROUND CANOPY COVER**

The White Rectangle or Round Canopy Cover conceals the TE-60L-12 LED Transformer (sold separately) inside a Single Gang Box to power Dots and Pucks.

Product	Finish
<b>3RE</b>	<b>WH</b>
3RE 3" Rectangle Canopy Cover	WH White
4RD 4" Round Canopy Cover	

PROJECT		FIXTURE TYPE		DATE	
---------	--	--------------	--	------	--

**WIRING DIAGRAM** Wiring Diagram for four Dot LED fixtures, Hardwired

- APPLICATION** Four Dot LED fixtures  
**POWER SUPPLY** 60 Watt, 120 Volt input, 12 Volt AC output, TE-60L-12  
**DIMMING** Dimmable with Low Voltage Electronic Dimmer using Power Supply above, see Power Supply spec sheet for additional details  
 Lutron: Diva #DVELV-300P; Skylark #SELV-300P dimmers are recommended

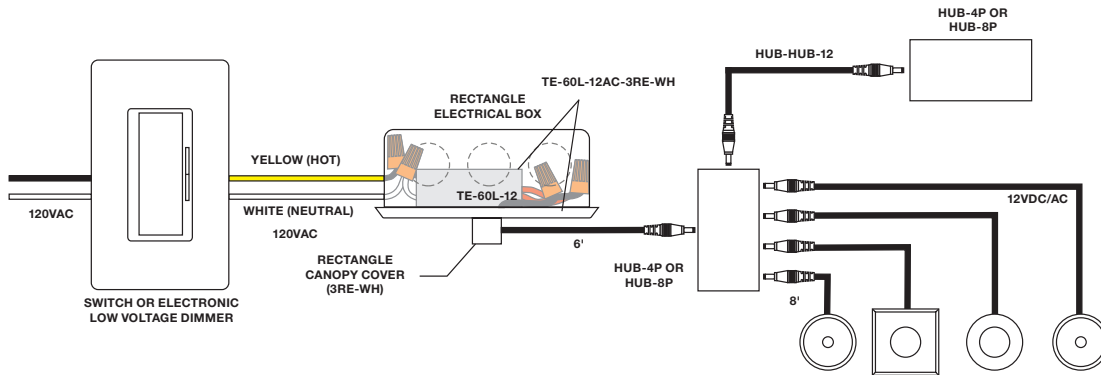

**WIRING DIAGRAM** Wiring Diagram for seven Dot LED fixtures, Plug-In

- APPLICATION** Seven Dot LED fixtures  
**POWER SUPPLY** 60 Watt, 120 Volt input, 12 Volt AC output, TE-60L-12AC-P  
**DIMMING** Dimmable with Low Voltage Electronic Dimmer using Power Supply above, see Power Supply spec sheet for additional details  
 Lutron: Diva #DVELV-300P; Skylark #SELV-300P dimmers are recommended

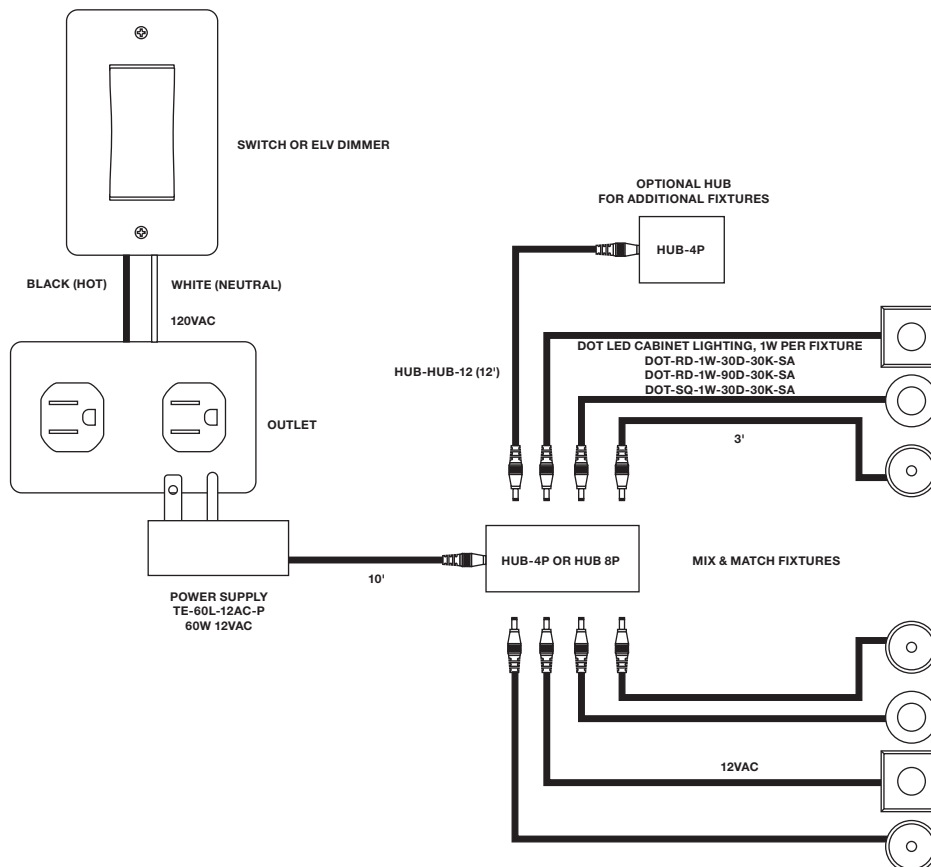

PROJECT		FIXTURE TYPE		DATE	
---------	--	--------------	--	------	--