

LIGHT CHANNEL 0.6" DIY RECESSED MILLWORK

24VDC, DO-IT-YOURSELF IN STATIC & TUNABLE WHITE, WARM DIM, RGB, MONOCHROMATIC COLOR & RGBTW

DESIGNED BY GREGORY KAY | ASSEMBLED IN AMERICA

REV 02.12.24

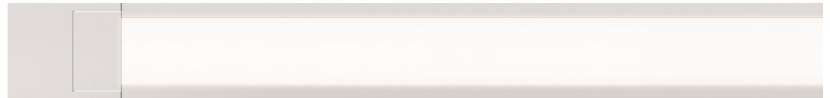
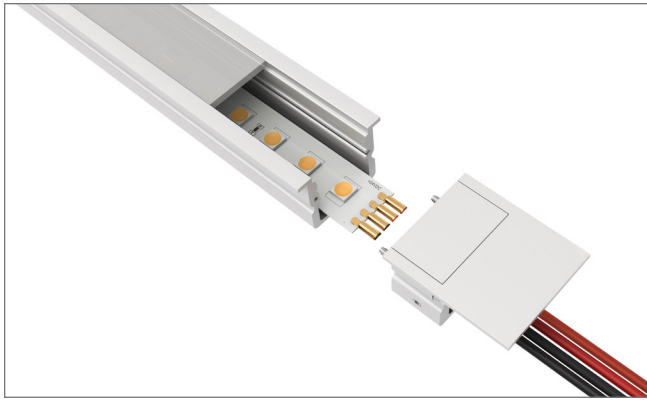

LCMW.6 Light Channel Diffused Lens



LCMW.6 Light Channel Clear Lens



LCMW.6 Light Channel Diffused Lens with White Louver

DESCRIPTION

Our DIY (Do-it-Yourself) Light Channel .6" Recessed Millwork is tailored for projects requiring a seamless design with ample illumination. The shallow profile integrates into various depths of millwork, while the flat 1/8" finished flange offers a minimal aesthetic, enhancing spaces with depth and dimension, seamlessly blending into the architecture while delivering premium task lighting for applications like under cabinets, bathrooms, work surfaces, and more. Our slim, aluminum channel extrusions, LED strips, and lenses are field-cuttable and ordered in various increments anywhere from 2 to 7 watts per foot. Offered in a broad range of wattages and Color Temperatures from 2400K through 4000K, Warm Dim (**27D** or **30D**), Tunable White (**2K6K** or **27K6**), Dynamic **RGB**, **RGB+White** in 2000K (special order in 27K, 30K and 40K), and **TruColor™ RGBTW** Color Changing RGB with Tunable White 2000K-6500K. Available with a diffused white or clear lens for maximum light levels, both offered with black or white louver options. Includes a 5-year pro-rated warranty. For custom quotes and layout assistance, send your drawings and ideas to our design team: design@PureEdgeLighting.com.

FEATURES & BENEFITS

- 24VDC LED Stomp Strip is high performance, highly durable and designed to withstand the harsh elements of a job site, including stomping and twisting
- Gold Plated Contacts prevent oxidation ensuring longevity of the LEDs
- Cut and assemble in field
- Solderless Pin Connectors reduce labor during installation
- 24VDC LED Strip offers excellent color-rendering
- Slim aluminum channel extrusions, LED strips and lenses are easily cut and assembled in the field
- Available in various wattages from 2 to 7 watts per foot

LENS OPTIONS

- Clear Lens (**C**) provides maximum illumination use of a transparent lens, LEDs diodes will be visible
- Clear Lens White Louver (**CLW**)
- Clear Lens Black Louver (**CLB**)
- Diffused White Lens (**D**) projects clean lines of light eliminating pixelation
- Diffused Lens White Louver (**DLW**)
- Diffused Lens with Gel Color Filter (**G**) (Provided by Customer) Clear and Diffuser Lens are Gel Color Filter Suitable allowing for color personalization. Zircon LED Gel filters recommended. Purchase Gel Lens from www.leefilters.com. See manufacturer spec sheet for more information

LAMP

- Static White Color Temperatures ranging from **2400K** through **4000K**
- Warm Dim: **27D** and **30D** dim down to 1800K, resembling halogen light sources
- Tunable White: **2K6K** and **27K6** grants independent control for adjusting color temperature and intensity
- Dynamic RGB & RGB+White in 2000K (**RGB**, **RGB20K**) (special order in 27K, 30K and 40K)
- **TruColor™ RGBTW** Dynamic RGB with Tunable White 2000K-6500K
- Average life: 50,000 hours

REQUIRED COMPONENTS

- Light Channel .6 Millwork and Lens (Mounting Clips included with every 2' of channel)
- End Caps (sold in pairs)
- 24VDC Light Channel Power Connector
- 24VDC LED Strip

REMOTE POWER SUPPLIES*, DIMMERS & CONTROLS (SOLD SEPARATELY)

- Pure Smart™ WiZ Pro Power Supplies & Controls
- UNI Driver: Universal Dimming (**TRIAC**, **ELV**, **0-10V**) with corresponding dimmer
- 0-10V dimming with 0-10V remote power supplies
- Electronic Low Voltage Dimming (**ELV**)
- Dynamic Color Changing (**DMX**)
- DALI/DALI-2
- Lutron Hi-Lume®

*In-Wall Mounting Kits available for select power supplies

**See LED Strips on following pages for correlating power supplies

COMPLIANCE

*Title 24 JA8 listed for 2700K CCT and above when used with PureEdge remote Universal power supplies, ETL, Class 2, Damp Location, Made in USA.

APPLICATIONS

Provides maximum light levels for task and general illumination. Indoor only - Under/above cabinet, cove, and retail, recessed into millwork.

PROJECT	FIXTURE TYPE	DATE
---------	--------------	------

LIGHT CHANNEL 0.6" DIY RECESSED MILLWORK

24VDC, DO-IT-YOURSELF IN STATIC & TUNABLE WHITE, WARM DIM, RGB, MONOCHROMATIC COLOR & RGBTW

REV 02.12.24

REQUIRED COMPONENTS: Select Light Channel .6 Recessed Millwork option, End Caps and Power Connector based on lighting design.

C LCMW.6 Light Channel Clear Lens

Antique Bronze
White
Satin Aluminum with Black Louvers
Antique Bronze with White Louvers

0.88" (2.2cm)
0.59" (1.5cm)
0.61" (1.5cm)
0.55" (1.4cm)
0.7" (1.8cm)

D LCMW.6 Light Channel Diffused Lens

Antique Bronze
White
Satin Aluminum with Black Louvers
Antique Bronze with White Louvers

0.88" (2.2cm)
0.59" (1.5cm)
0.61" (1.5cm)
0.55" (1.4cm)
0.7" (1.8cm)

G LCMW.6 Light Channel Diffused Lens with Gel Color Filter (provided by customer)

GEL FILTER
0.5" (1.3cm)

0.88" (2.2cm)
0.59" (1.5cm)
0.61" (1.5cm)
0.55" (1.4cm)
0.7" (1.8cm)

LIGHT CHANNEL .6 RECESSED MILLWORK
Start the ordering process by selecting the desired length and lens option. Next, order the LED Strip, End Caps and Power Feed. At 0.61" tall the channel has a low profile, made of aluminum with 3 finish options, and fits a 24VDC LED Strip inside. The channel and lens may be cut in the field, and may be joined together using Wago lever nuts. Mounting Clips are included with every 2' of channel, and can also be ordered separately as replacement parts.

FINISHES



System	Length in Feet	Lens	Finish
LCMW.6	10FT	D	SA
LCMW.6 Light Channel 0.6" Recessed Millwork	2FT 2' 4FT 4' 5FT 5' 8FT 8' 10FT 10'	D Diffused Lens C Clear Lens DW Diffused Lens with White Louver DB Diffused Lens with Black Louver CW Clear Lens with White Louver CB Clear Lens with Black Louver	BZ Antique Bronze SA Satin Aluminum WH White

Front View
0.61" (1.5cm)
0.7" (1.8cm)
0.88" (2.2cm)

Side View
0.04" (0.1cm)
0.43" (1.1cm)
1" (2.5cm)

END CAPS

End Caps are sold in pairs and provide a finished look at the end of a run as well as hold the required power connector.

System	Product	Type	Finish
LCMW.6	SLC	CA	SA
LCMW.6 Light Channel 0.6" Recessed Millwork	SLC Solderless Light Channel	CA End Caps	SA Satin Aluminum BZ Antique Bronze WH White

PROJECT		FIXTURE TYPE		DATE	
---------	--	--------------	--	------	--

LIGHT CHANNEL 0.6" DIY RECESSED MILLWORK

24VDC, DO-IT-YOURSELF IN STATIC & TUNABLE WHITE, WARM DIM, RGB, MONOCHROMATIC COLOR & RGBTW

REV 02.12.24

LIGHT CHANNEL POWER CONNECTOR

One Female Power Connector is included with each order of channel. For jumper connections, we recommend using WAGO 221 Lever Nuts according to your specific application requirements.

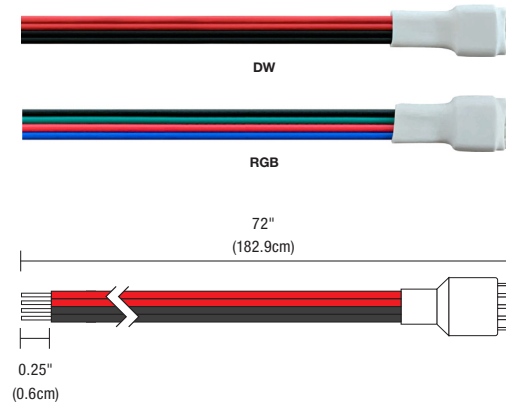

System	Type	Product	Length	Color Temperature
SS	FE	CON	72IN	DW
SS Stomp Strip/Soft Strip	FE Female Connector	CON Connector	72IN 72 Inches	DW Static White/Warm Dim RGB RGB (Tunable White Compatible)

ACCESSORIES: Order based on lighting design or as replacement parts.

CANOPY COVER & SPLICE BOX

Use for remote located power supply. The 3 inch rectangle or 4 inch round white canopy covers the electrical box and feeds wires for Light Channel. The Splice Box provides a safe enclosure for low voltage connections.

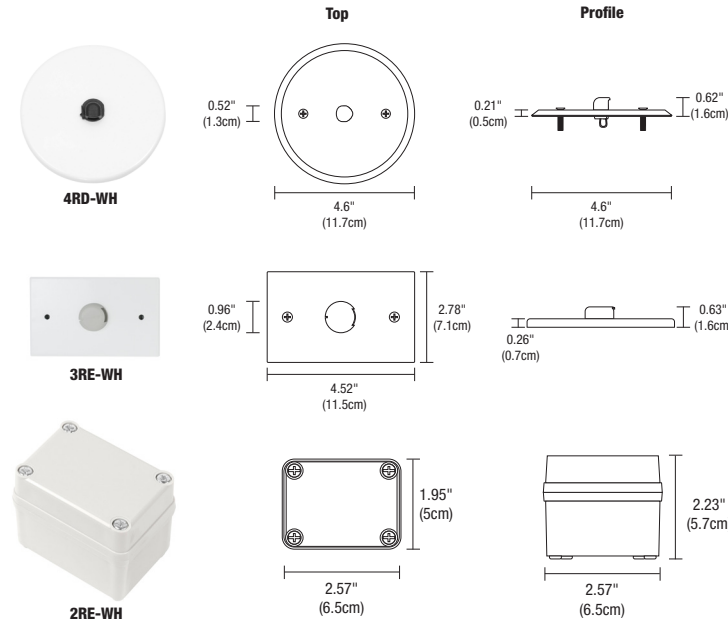

Product	Finish
3RE	WH
3RE 3" Rectangle Canopy Cover	WH White
4RD 4" Round Canopy Cover	
2RE-JBOX 2" Rectangle Splice Box	

PROJECT	FIXTURE TYPE	DATE
---------	--------------	------

LIGHT CHANNEL 0.6" DIY RECESSED MILLWORK

24VDC, DO-IT-YOURSELF IN STATIC & TUNABLE WHITE, WARM DIM, RGB, MONOCHROMATIC COLOR & RGBTW

REV 02.12.24

TRUCOLOR™ RGBTW COMPONENTS

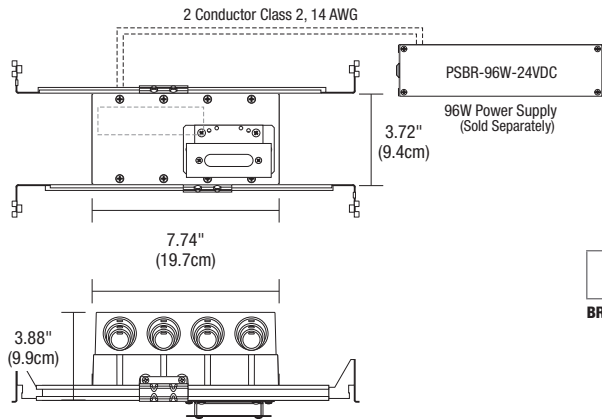

1" RECTANGLE CANOPY WITH 4 GANG JUNCTION BOX AND PURE SMART WIZ PRO CV BRIDGEBOX

The slim profile 1RE Canopy with 4 Gang Junction Box comes with adjustable hanger bars and a Pure Smart WiZ Pro 96 watt CV bridgebox allowing for 5-channel, wireless control of the TruColor RGBTW Luminaire. Two Class 2, 14AWG stranded conductors from the Remote Power Supply up to 40 ft away are required.

System	Canopy	Wattage	Control	Color Temperature	System Code
BR	1RE4G	96W	WZ	TC5W5	LC
BR Bridgebox Remote	1RE4G 1" Rectangle Canopy with 4 Gang Junction Box	96W 96 Watts	WZ WiZ pro Connected CV Smart Bridgebox Included	TC5W5 TruColor™ 5 watts RGB & 5 watts Tunable White TC5W7 TruColor™ 5 watts RGB & 7 watts Tunable White	LC Light Channel

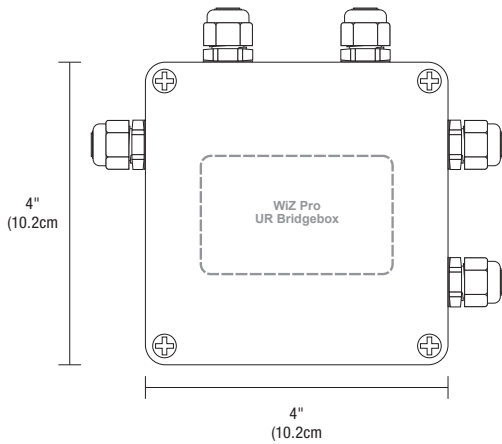

T BAR DROP CEILING SURFACE 4" SQUARE GANG JBOX AND PURE SMART WIZ PRO UR BRIDGEBOX

The 4" Square Junction Box located above Tbar ceiling includes connectors for fast and secure connection to the RGBTW fixture and Pure Smart WiZ Pro 96 watt UR bridgebox allowing for 5-channel, wireless control of the TruColor™ RGBTW fixture. Requires two Class 2, 14 AWG stranded conductors from the Remote Power Supply up to 40 ft away. Can be quick shipped for rough-in.

Type	Component	Wattage	Control System	Color Temperature Options	System
BR	4SQ	96W	WZ	TC5W5	LC
BR Bridgebox Remote	4SQ 4 Square Junction Box, 1 to 5 connector outputs	96W 96 Watts	WZ WiZ pro Connected UR Smart Bridge box Included	TC5W5 TruColor™ 5 watts RGB & 5 watts Tunable White TC5W7 TruColor™ 5 watts RGB & 7 watts Tunable White	LC Light Channel

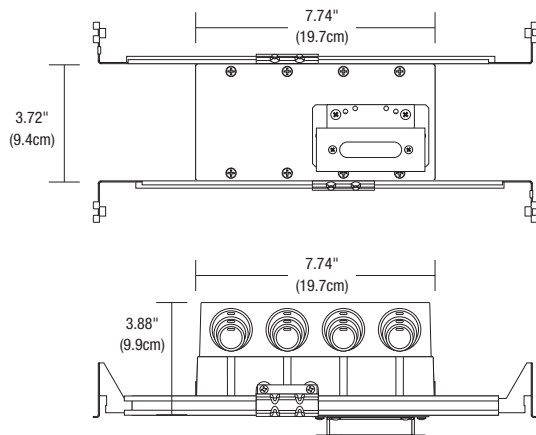

1" RECTANGLE CANOPY & 4 GANG JUNCTION BOX

The Junction Box opening is covered by the fixture for a clean no Canopy look. Includes 4 gang Junction Box with adjustable bar hangers. Includes a Goof Plate, for poor plastering around J-box. Can be quick shipped for rough-in.

Type	Component	Ceiling/Wall Type
C	1RE	JB4G
C Channel	1RE 1" Rectangle End Feed	JB4G 6 Conductor 4 Gang Junction Box

PROJECT	FIXTURE TYPE	DATE
---------	--------------	------

LIGHT CHANNEL 0.6" DIY RECESSED MILLWORK

24VDC, DO-IT-YOURSELF IN STATIC & TUNABLE WHITE, WARM DIM, RGB, MONOCHROMATIC COLOR & RGBTW

REV 02.12.24



CV BRIDGE BOX ONLY

The Pure Smart™ Class2 wiring Type, for use in tight spaces like a cabinet. CV96W RGBTW Bridgebox enables wireless control of a constant voltage, 5 Channel RGBTW LED load with the WiZ Pro wireless control ecosystem. For use with Non-Dim PSB (PSBR-96W-24VDC).

Product	Wattage	Color Temperature Options	System
BR	CV96W	TC5W5	LC
BR Bridgebox	CV96W Slim Profile WIZ Bridgebox	TC5W5 TruColor™ RGBTW 5 watts RGB & 5 watts Tunable White TC5W7 TruColor™ RGBTW 5 watts RGB & 7 watts Tunable White	LC Light Channel



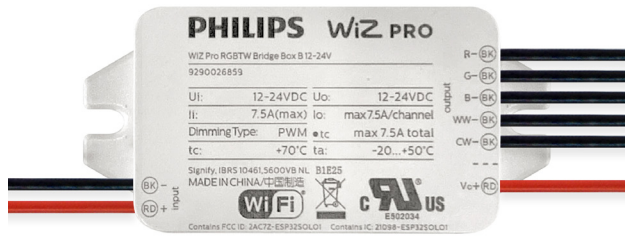

PURE SMART/WIZ PRO UR BRIDGEBOX

The Phillips WiZ Pro Type UR RGBTW Bridgebox is a low voltage Class 2 wireless control module allowing for 5 Channel (RGBTW) full color control within the WiZ Pro wireless control ecosystem. Same as UR but with mounting holes. 24V input voltage For use with Non-Dim PSB (PSBR-96W-24VDC).

Type	Wattage	Color Temperature Options	System
BRBOX	UR96W	TC5W5	LC
BRBOX Bridgebox	UR96W 96 Watts	TC5W5 TruColor™ RGBTW 5 watts RGB & 5 watts Tunable White TC5W7 TruColor™ RGBTW 5 watts RGB & 7 watts Tunable White	LC Light Channel



POWER FEED/FLEXIBLE CONNECTOR

Flexible connectors link two sections of LED Strip end to end. To use as a Power Feed cut off the male end, and connect to the power supply.

Product	Type	Type	Size	Color Temperature
SS	FE	CON	6IN	RGBTW
SS Stomp Strip/Soft Strip	FE Female Connector	CON Connector	6IN 6 Inches 72IN 72 Inches	RGBTW Red, Green, Blue, and Tunable White

PROJECT		FIXTURE TYPE		DATE	
---------	--	--------------	--	------	--

LIGHT CHANNEL 0.6" DIY RECESSED MILLWORK

24VDC, DO-IT-YOURSELF IN STATIC & TUNABLE WHITE, WARM DIM, RGB, MONOCHROMATIC COLOR & RGBTW

REV 02.12.24

Light Channel .6 Recessed Millwork system overview

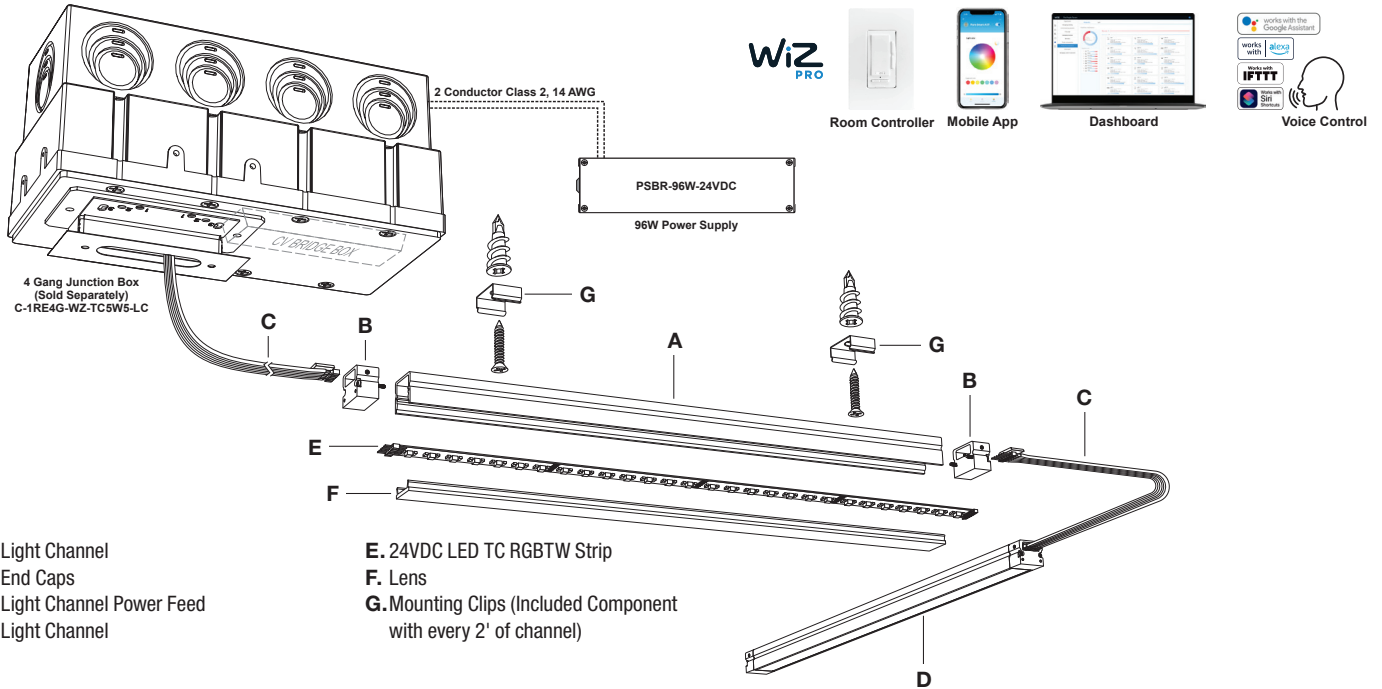

Network Topology

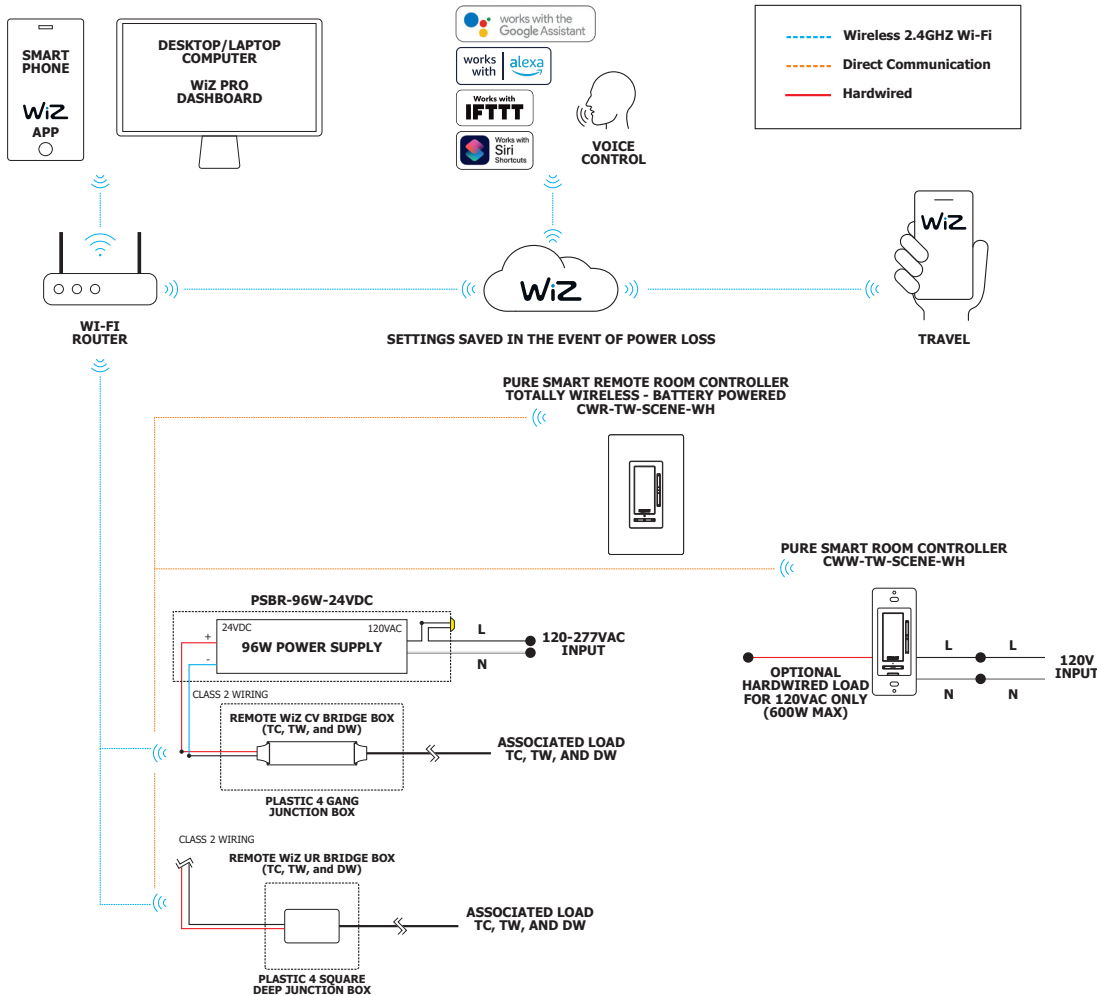

PROJECT		FIXTURE TYPE		DATE	
---------	--	--------------	--	------	--

STOMP STRIP, STATIC WHITE

24VDC WITH PIN CONNECTORS

DESIGNED BY GREGORY KAY | ASSEMBLED IN AMERICA

REV 02.06.24

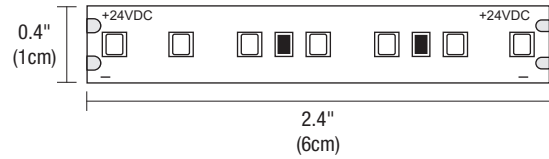
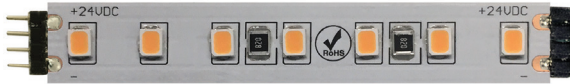

Our Low Voltage LED strips are highly durable, designed to withstand the harsh elements of a job site, and precision engineered to provide superior color rendering up to 92+ CRI. Both Stomp Strip and Soft Strip are used for our **DIY** (Do-it-Yourself) fixtures and systems.

FEATURES & BENEFITS

- Offered with pin connectors reducing time and labor during installation
- Developed to meet popular demand for resilient performance without sacrificing output, color rendering and efficacy
- Tolerance: Created to resist damage in rigorous environments such as busy commercial jobsites
- Compact LED spacing: Produces uniform light distribution without visible diodes or hot spots when used within a diffused lens
- 4oz Layer of Copper Busbar: Provides superior heat dissipation and less voltage drop equivalent to 14AWG wire
- Premium Coating: Optically Clear Silicone prevents fading over time
- Mounting: Industrial 3M tape lined strip for strong, self-adhesion to most smooth, finished surfaces
- Suitable for indoor damp locations
- Warranty: Includes a 5-year pro-rated warranty

MAXIMUM LENGTHS BEFORE RE-FEEDING

- 2WDC, 2.5 watts per foot - 40'
- 5WDC, 4.4 watts per foot - 20'
- 7WDC, 7.3 watts per foot - 12'

LAMP

- Offered in multiple Static White Color Temperatures: 2400K, 2700K, 3000K, 3500K & 4000K
- Average life: 50,000 hours

SPECIFICATIONS

- 24VDC
- 2.5, 4.4, or 7.3 watts per foot
- Sold in 1' increments
- Field-cutable in 2.4" increments
- Operating temperature: -22°F to 140°F (-30°C to 60°C)

REMOTE POWER SUPPLIES*, DIMMING & CONTROLS (SOLD SEPARATELY)

24VDC, Class 2 wiring

- [Pure Smart™ WIZ Pro Power Supplies & Controls](#)
- [UNI Driver: Universal Dimming \(TRIAC, ELV, 0-10V\)](#)
- [DALI/DALI-2](#)
- [Lutron Hi-Lume/Ecosystem](#)

*In-Wall Mounting and drop ceiling Kits available for select power supplies

APPROVALS

Class 2 Wiring up to 100 watts, Indoor Damp Location Suitable, RoHS, ETL listed.

NOMINAL LAMP DATA	ST2A					ST5A					ST7A				
	2.5W					4.4W					7.3W				
WATTS PER FOOT															
COLOR TEMPERATURE	24K	27K	30K	35K	40K	24K	27K	30K	35K	40K	24K	27K	30K	35K	40K
LUMENS PER FOOT (lm/ft)	284	287	299	343	362	525	531	553	634	669	811	820	854	980	1033
LUMENS PER WATT (lm/w)	114	115	120	137	145	119	121	126	144	152	111	112	117	134	142
CRI	92+	92+	92+	92+	92+	92+	92+	92+	92+	92+	92+	92+	92+	92+	92+

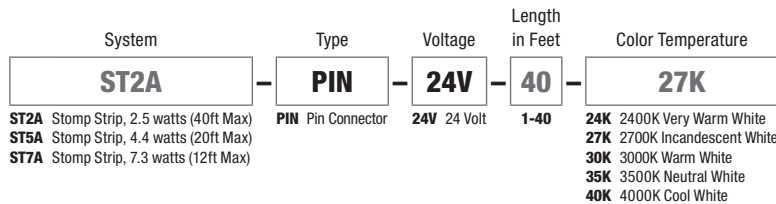

PROJECT		FIXTURE TYPE		DATE	
---------	--	--------------	--	------	--

WARM DIM, STOMP STRIP

24VDC WITH PIN CONNECTORS

DESIGNED BY GREGORY KAY | ASSEMBLED IN AMERICA

REV 02.06.24

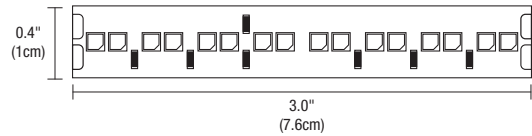
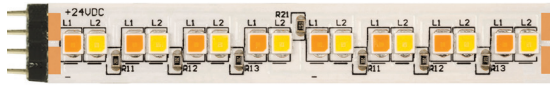

CAN'T STOMP ME OUT

Our Low Voltage Stomp Strip is highly durable, designed to withstand the harsh elements of a job site, and precision engineered to provide superior color rendering up to 94+ CRI. Warm Dim technology (**27D & 30D**) mimics an incandescent atmosphere by decreasing the color temperature as you dim. Our Warm Dim strips can be dimmed all the way down to a soothing amber hue at 1800K, reminiscent of candlelight along the halogen curve. Stomp Strip is used for our **DIY** (Do-it-Yourself) fixtures and systems. For custom quotes and layout assistance, send your drawings and ideas to our design team: design@PureEdgeLighting.com.

FEATURES & BENEFITS

- Offered with pin connectors reducing time and labor during installation
- Developed to meet popular demand for resilient performance without sacrificing output, color rendering and efficacy
- Tolerance: Created to resist damage in rigorous environments such as busy commercial jobsites
- Compact LED spacing: Produces uniform light distribution without visible diodes or hot spots when used within a diffused lens
- 4oz Layer of Copper Busbar: Provides superior heat dissipation and less voltage drop equivalent to 14AWG wire
- Premium Coating: Optically Clear Silicone prevents fading over time
- Mounting: Industrial 3M tape lined strip for strong, self-adhesion to most smooth, finished surfaces
- Suitable for indoor damp locations
- Warranty: Includes a 5-year pro-rated warranty

MAXIMUM LENGTHS BEFORE RE-FEEDING

- 5WDC, 4.8 watts per foot - 20'

LAMP

- **27D** dims from 2700K down to 1800K, and **30D** dims from 3000K down to 2000K, resembling Halogen light sources.
- Average life: 50,000 hours

SPECIFICATIONS

- 24VDC
- 4.8 watts per foot
- Sold in 1' increments
- Field-cutable in 3" increments
- Operating temperature: -22°F to 140°F (-30°C to 60°C)

REMOTE POWER SUPPLIES*, DIMMING & CONTROLS (SOLD SEPARATELY)

24VDC, Class 2 wiring

- [UNI Driver: Universal Dimming \(TRIAC, ELV, 0-10V\)](#)
- [DALI/DALI-2](#)
- [Lutron Hi-Lume/Ecosystem](#)

*In-Wall Mounting and drop ceiling Kits available for select power supplies

MAKE IT SMART

[Pure Smart™ Wi-Fi Dimmer](#)

APPROVALS

Class 2 Wiring up to 100 watts, Indoor Damp Location Suitable, RoHS, ETL listed.

NOMINAL LAMP DATA	ST5A	
WATTS PER FOOT	4.8W	
COLOR TEMPERATURE	27D	30D
LUMENS PER FOOT (lm/ft)	606	631
LUMENS PER WATT (lm/w)	126	131
CRI	94+	94+

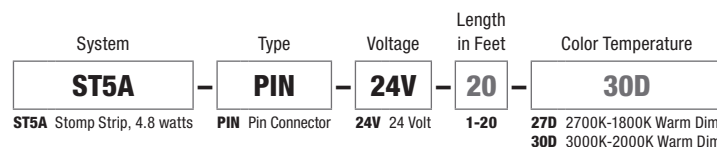

PROJECT	FIXTURE TYPE	DATE
---------	--------------	------

PRO WARM DIM, STOMP STRIP

24VDC WITH PIN CONNECTORS

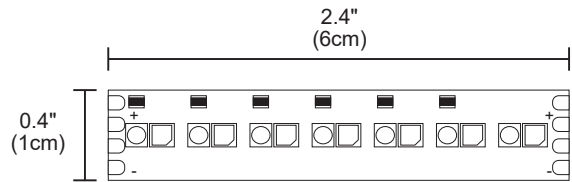
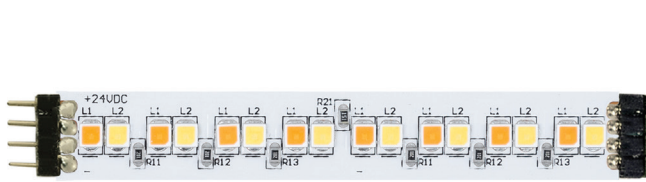

FEATURES & BENEFITS

- Pro Dim LED Strip provides adaptable dim to warm light with 0.1% Dim to off
- High CRI LEDs, offering superior color rendering and enhanced color
- Offered in 2W, 5W, & 7W watts per foot
- The 0.4" (10mm) wide strip contains 35 LEDs per foot (7 LEDs per 2.4" Increment): Tight spacing of LEDs produce uniform light distribution without visible diodes or pixelation when used within a diffused lens
- Gold Plated Contacts: Prevent oxidation ensuring longevity of the LEDs
- 4oz Layer of Copper Busbar: Provides superior heat dissipation and less voltage drop equivalent to 14AWG wire
- Premium Coating: Optically Clear Silicone prevents fading over time
- Mounting: Industrial 3M tape lined strip for strong, self-adhesion to most smooth, finished surfaces
- Applications: Indoor, damp and dry locations
- Warranty: Includes a 5-year pro-rated warranty

MAXIMUM LENGTHS BEFORE RE-FEEDING

- 2WDC, 2.5 watts per foot - 40'
- 5WDC, 5 watts per foot - 20'
- 7WDC, 7.5 watts per foot - 12'

LAMP

- Available in 2700K **27KPD** (dims down to 1800K) and **3000K** (30KPD) that dims down to 2000K
- Linear Dimming Curve
- Designer Grade High CRI 92+ LEDs
- Average life: 50,000 hours

SPECIFICATIONS

- 24VDC, 120-277VAC Input
- 2.5, 5, and 7.5 watts per foot
- Sold in 1' increments
- Field-cutable in 2.4" increments
- Operating temperature: -22°F to 140°F (-30°C to 60°C)

REMOTE POWER SUPPLIES*, DIMMING & CONTROLS (SOLD SEPARATELY)

24VDC, Class 2 wiring

- [Pro Dim Power Supplies & Controls](#)

*In-Wall Mounting Kits available for select Power Supplies

APPROVALS

Class 2 Wiring up to 100 watts, Indoor Damp Location Suitable, RoHS, ETL listed.

NOMINAL LAMP DATA							
DESCRIPTION	ST2A KPD		ST5A KPD		ST7A KPD		
WATTS PER FOOT	2W (2.5 watts)		5W (5 watts)		7W (7.5 watts)		
COLOR TEMPERATURE	27KPD	30KPD	27KPD	30KPD	27KPD	30KPD	
LUMENS PER FOOT (lm/ft)	165	173	426	451	523	548	
LUMENS PER WATT (lm/w)	66	69	66	69	58	61	
CRI	92+	92+	92+	92+	92+	92+	

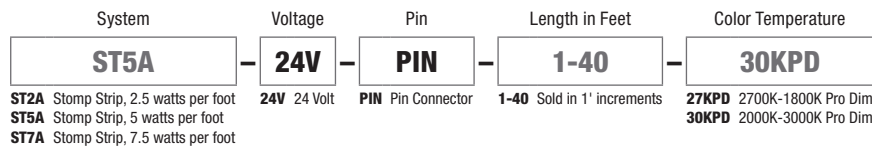

PROJECT		FIXTURE TYPE		DATE	
---------	--	--------------	--	------	--

STOMP STRIP, TUNABLE WHITE

24VDC WITH PIN CONNECTORS

DESIGNED BY GREGORY KAY | ASSEMBLED IN AMERICA

REV 02.06.24

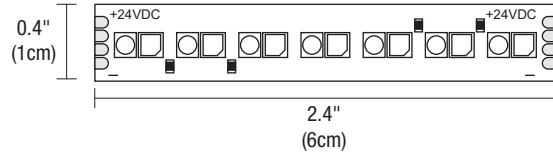

CAN'T STOMP ME OUT

Our Low Voltage Tunable White Stomp Strip is highly durable, designed to withstand the harsh elements of a job site, and precision engineered to provide superior color rendering up to 94+ CRI. Tunable White 2000K-6500K (**2K6K**) or 2700K-6500K (**27K6**) grants independent control and adjustment of color temperature and intensity from 2000K (Sunset) through 6500K (Day Light White). Tunable white lighting visually, biologically and emotionally contributes to human interaction with the physical world. Human centric lighting (HCL) builds on this technology bringing the dynamics of natural daylight indoors, and delivering a positive effect on human health, well-being and performance. Stomp Strip is used for our **DIY** (Do-it-Yourself) fixtures and systems.

FEATURES & BENEFITS

- Offered with pin connectors reducing time and labor during installation
- Developed to meet popular demand for resilient performance without sacrificing output, color rendering and efficacy
- Tolerance: Created to resist damage in rigorous environments such as busy commercial jobsites
- Compact LED spacing: Produces uniform light distribution without visible diodes or hot spots when used within a diffused lens
- 4oz Layer of Copper Busbar: Provides superior heat dissipation and less voltage drop equivalent to 14AWG wire
- Premium Coating: Optically Clear Silicone prevents fading over time
- Mounting: Industrial 3M tape lined strip for strong, self-adhesion to most smooth, finished surfaces
- Suitable for indoor damp locations
- Warranty: Includes a 5-year pro-rated warranty

LAMP

- Tunable White: 2000K-6500K (**2K6K**) and 2700K-6500K (**27K6**) grants independent control for adjusting color temperature and intensity
- Average life: 50,000 hours

SPECIFICATIONS

- 24VDC
- 2.5, 4.6, or 7.5 watts per foot
- Sold in 1' increments
- Field-cuttable in 2.4" increments
- Operating temperature: -22°F to 140°F (-30°C to 60°C)

REMOTE POWER SUPPLIES*, DIMMING & CONTROLS (SOLD SEPARATELY)

24VDC, Class 2 wiring

- [Pure Smart™ WiZ Pro Power Supplies & Controls](#)
- [0-10V](#): Requires two dimmers, one for intensity and one for color temperature
- [DMX Dynamic Color Changing](#)
- [Controllers](#)
- [DALI/DALI-2](#)

*In-Wall Mounting and drop ceiling Kits available for select power supplies

MAXIMUM LENGTHS BEFORE RE-FEEDING

- 2WDC, 2.5 watts per foot - 40'
- 5WDC, 4.6 watts per foot - 20'
- 7WDC, 7.5 watts per foot - 12'

APPROVALS

Class 2 Wiring, Indoor Damp Location Suitable, RoHS, ETL listed.

NOMINAL LAMP DATA	ST2A 2K6K										ST5A 2K6K										ST7A 2K6K									
	2.5 Watts										4.6 Watts										7.5 Watts									
WATTS PER FOOT																														
COLOR TEMPERATURE	20K	22K	24K	27K	30K	35K	40K	57K	65K	20K	22K	24K	27K	30K	35K	40K	57K	65K	20K	22K	24K	27K	30K	35K	40K	57K	65K			
LUMENS PER FOOT (lm/ft)	152	154	156	158	160	165	180	194	208	368	383	398	413	428	458	491	496	500	512	536	560	584	608	656	691	698	705			
LUMENS PER WATT (lm/w)	82	77	78	79	80	82	90	97	115	80	80	83	86	89	95	102	103	109	80	74	78	81	84	91	96	97	110			
CRI	91+	91+	91+	94+	93+	92+	92+	91+	91+	91+	91+	91+	94+	93+	92+	92+	91+	91+	91+	91+	91+	94+	93+	92+	92+	91+	91+			

NOMINAL LAMP DATA	ST2A 27K6								ST5A 27K6								ST7A 2K6K							
	2.5 Watts								4.6 Watts								7.5 Watts							
WATTS PER FOOT																								
COLOR TEMPERATURE	27K	30K	35K	40K	45K	57K	65K	27K	30K	35K	40K	45K	57K	65K	27K	30K	35K	40K	45K	57K	65K			
LUMENS PER FOOT (lm/ft)	164	195	201	206	225	242	231	411	420	436	452	447	443	442	555	567	589	610	603	598	596			
LUMENS PER WATT (lm/w)	82	78	80	82	90	97	115	103	91	95	98	97	96	110	87	79	82	85	84	83	93			
CRI	94+	93+	92+	92+	92+	92+	91+	94+	93+	92+	92+	92+	92+	91+	94+	93+	92+	92+	92+	92+	91+			

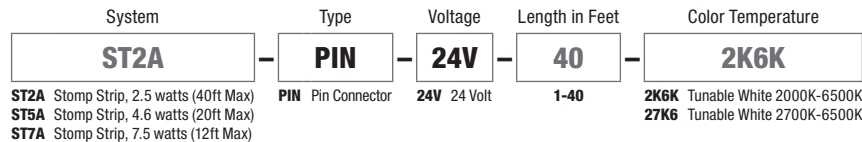

PROJECT		FIXTURE TYPE		DATE	
---------	--	--------------	--	------	--

SOFT STRIP, RGB

24VDC WITH PIN CONNECTORS

DESIGNED BY GREGORY KAY | ASSEMBLED IN AMERICA

REV 02.06.24

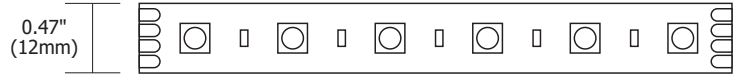

DESCRIPTION

PureEdge RGB Soft Strip provides dynamic color effects with red, green and blue LEDs. Our color-changing LED strip provides bright, continuous light offered in two wattage options of 3 or 5 watts per foot. PureEdge's focus on chromacity quality provides a balanced output across the color gamut, allowing the creation of millions of beautiful colors. The flexible strip is sold in 1 foot increments. RGB Soft Strip can be controlled using a compatible 24 volt DC power supply with an integrated RGB DMX driver. Includes a flexible aluminum heat sink to extend LED life. Both Stomp Strip and Soft Strip are used for our **DIY** (Do-it-Yourself) fixtures and systems.

SPECIFICATIONS

- 24VDC, Class 2
- Power Consumption: 2.6 or 5 watts per foot
- Maximum Lengths Before Re-feeding: SS3- 36', SS5- 20'
- Sold in 1' increments
- Field-cutttable in increments: SS3- 4" SS5- 2.4"
- Operating temperature: -22°F to 140°F (-30°C to 60°C)

MAXIMUM LENGTHS BEFORE RE-FEEDING

SS3, 2.6 watts per foot - 36'
 SS5, 5 watts per foot - 20'

MOUNTING

Self-adhering SS6 mounts to most smooth finished surfaces with industrial strength 3M tape (provided on back of strip); some unfinished surfaces may require screw-in mounting clips **SS-MCL** (sold separately).

LAMP

- RGB: Dynamic Red, Green, and Blue
- Wattage options: 3 or 5 watts
- 50,000 Hour Lamp Life

ACCESSORIES (SOLD SEPARATELY)

- 24VDC Power Connectors and Jumpers
- Flexible Connectors
- Mounting Straps & Clips

REMOTE POWER SUPPLIES*, DIMMING & CONTROLS (SOLD SEPARATELY)

24VDC, Class 2 wiring

- [Pure Smart™ WIZ Pro Power Supplies & Controls](#)
- [DMX Dynamic Color Changing](#)
- [Controllers](#)
- [DALI/DALI-2](#)

*In-Wall Mounting and drop ceiling Kits available for select power supplies

APPLICATIONS

Designed for any Indoor space, including Damp locations. Ideal applications in Residential, Commercial, Retail, and Hospitality environments.

APPROVALS

Class 2 Wiring, Indoor Damp Location Suitable, RoHS, ETL listed.

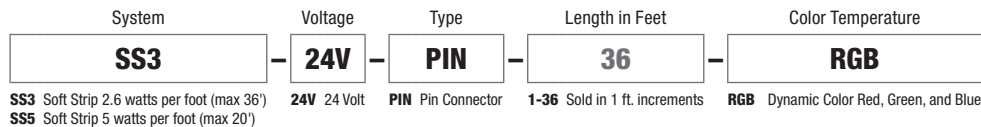

PROJECT		FIXTURE TYPE		DATE	
---------	--	--------------	--	------	--

SOFT STRIP, RGB+WHITE

24VDC WITH PIN CONNECTORS

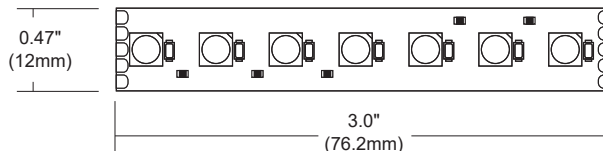

DESCRIPTION

PureEdge's RGB+White Soft Strip (**SS6**) provides dynamic color effects with red, green, blue plus white. Now offered with four choices of White; 2000K and special order in 2700K, 3000K, and 4000K. Our color-changing LED strip provides bright, continuous light, our focus on chromacity quality provides a balanced output across the color gamut, allowing the creation of millions of beautiful colors and pure white. The flexible strip is sold in 1 foot increments up to 16 ft with cutting increments every 3 inches. At 6.3 watts per foot, RGB+W can be controlled using a compatible 24 volt DC power supply with an integrated RGB DMX driver. SS6 includes a flexible aluminum heat sink to extend LED life. Includes 5 year pro-rated warranty.

SPECIFICATIONS

- 24VDC, Class 2
- Power Consumption: 6.3 watts per foot
- Maximum Length Before Re-feeding: 16'
- Sold in 1' increments
- Field-cutttable in 3" increments
- Operating temperature: -22°F to 140°F (-30°C to 60°C)

MOUNTING

Self-adhering SS6 mounts to most smooth finished surfaces with industrial strength 3M tape (provided on back of strip); some unfinished surfaces may require screw-in mounting clips **SS-MCL** (sold separately).

LAMP

- RGB+W: Dynamic Red, Green, Blue plus 2000K White
- Special order in 2700K, 3000K, and 4000K
- 50,000 Hour Lamp Life

REMOTE POWER SUPPLIES*, DIMMING & CONTROLS (SOLD SEPARATELY)

24VDC, CLASS 2 WIRING

- [Pure Smart™ WiZ Pro Power Supplies & Controls](#)
- [DMX Dynamic Color Changing](#)
- [Controllers](#)
- [DALI/DALI-2](#)

*In-Wall Mounting and drop ceiling Kits available for select power supplies

ACCESSORIES (SOLD SEPARATELY)

- 24VDC Power Connectors and Jumpers
- Flexible Connectors
- Mounting Straps & Clips

APPLICATIONS

Designed for any Indoor space, including Damp locations. Ideal applications in Residential, Commercial, Retail, and Hospitality environments.

APPROVALS

Class 2 Wiring, Indoor Damp Location Suitable, RoHS, ETL listed.

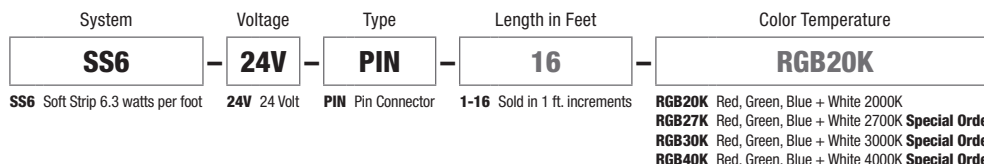

PROJECT		FIXTURE TYPE		DATE	
---------	--	--------------	--	------	--

TRUCOLOR™ RGB & TUNABLE WHITE LED STRIP

24VDC, 5 CHANNEL CONTROL, WITH PIN CONNECTORS

DESIGNED BY GREGORY KAY | ASSEMBLED IN AMERICA | PATENT PENDING

REV 02.06.24

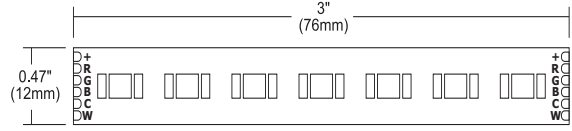
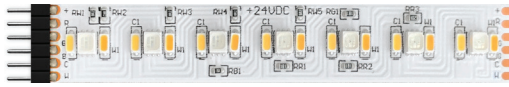

DESCRIPTION

PureEdge Pure Smart **TruColor™** technology uses five channels of tunable LEDs, composed of **RGBTW** red, blue, green, and Tunable White (**1500K-6500K**). With our precision-engineered, proprietary color mixing, we produce one of the widest, most accurate spectrums available, giving our customers access to the warm glow of the sunset (1500K-2400K golden hour) to the pure white light of the mid-day sun (5700K) and everything in between. **TruColor™** LED's achieve an average CRI-Color Rendering Index of 94+ and a Duv of +-0.0021 in relation to the blackbody curve at any point on the spectrum of tunable white CCT. Dynamic Color Changing functionality provides millions of possibilities for intricate customization, rich saturated or secondary colors, and unprecedented ease of installation, making **RGBTW** the ideal choice for residential and commercial applications. **TruColor™ RGBTW** adds more than just decorative flexibility; it also helps to support a healthy Circadian Rhythm and well-being. Let **TruColor™** transform your space and the people within it. 24VDC Remote Power Supplies required.

FEATURES & BENEFITS

- State-of-the-Art **TruColor™** (1500K-6500K) spectrum offers dynamic effects with RGB and Tunable White
- Optimized for use with WiZ Pro wire control ecosystem and Pure Smart Wi-Fi Room Controller. DMX control are also available.
- Offered with pin connectors reducing time and labor during installation
- Dims from full brightness down to 5%, and tuned anywhere from 1500K to 6500K.
- Developed to meet popular demand for resilient performance without sacrificing output, color rendering, CCT range, spectrum accuracy, or efficacy.
- Tolerance: Created to resist damage in rigorous environments such as busy commercial jobsites
- Compact LED spacing: Produces uniform light distribution without visible diodes or hot spots when used within a diffused lens
- Three 1oz Layers of Copper Busbar per foot provides superior heat dissipation and less voltage drop equivalent to 14AWG wire
- Premium Coating: Optically Clear Silicone prevents fading over time
- Mounting: Industrial 3M tape lined strip for strong, self-adhesion to most smooth, finished surfaces
- Warranty: Includes a 5-year pro-rated warranty

LAMP PERFORMANCE

- **TruColor™ RGBTW** Red, Green, and Blue with Tunable White (**1500K-6500K**)
- Average life: 50,000 hours

AVERAGE PERFORMANCE 2000K-5500K

- Average CRI: 97+
- Average DUV: +-0.0002
- Average R9: 91, Rg: 102, Rf: 93

SPECIFICATIONS

- 24VDC
- S5W5: 5W RGB & 5W Tunable White (WiZ: 5 watts total)
- S5W7: 5W RGB & 7W Tunable White (WiZ: 7 watts total)
- Sold in 1' increments
- Field-cutttable in 3" increments
- Operating temperature: -22°F to 140°F (-30°C to 60°C)

MAXIMUM LENGTHS BEFORE RE-FEEDING

- S5W5 – Pure Smart™ WiZ Pro: 20ft
- S5W7 – Pure Smart™ WiZ Pro: 12ft

REMOTE POWER SUPPLIES, DIMMERS & CONTROLS (SOLD SEPARATELY)

24VDC, Class 2 wiring

- [Pure Smart™ WiZ Pro PSBR Power Supplies](#)

Pure Smart™ PSBR Power Supply for Remote Bridgebox is developed to support Pure Smart TC TruColor RGBTW luminaires connected by WiZ Pro.

- [Pure Smart™ Wi-Fi Controller](#)

Features ON/OFF buttons, CCT and brightness control as well as four preset/custom scenes programmable in the WiZ app. Communicates via 2.4GHz Wi-Fi. No Hub needed. Voice control with Goggle Assistant, Alexa, Siri, Shortcuts, and IFTTT

APPLICATIONS

Designed for indoor use only. Ideal applications for residential, commercial, hospitality environments, and general human centric lighting.

APPROVALS

Class 2 Wiring up to 100 watts, Indoor Damp Location, ETL listed, RoHS.

NOMINAL LAMP DATA	S5W5 5W RGB & 5W TUNABLE WHITE										S5W7 5W RGB & 7W TUNABLE WHITE							
	20K	22K	24K	27K	30K	35K	40K	57K	65K	20K	22K	24K	27K	30K	35K	40K	57K	65K
WATTS PER FOOT																		
COLOR TEMPERATURE	20K	22K	24K	27K	30K	35K	40K	57K	65K	20K	22K	24K	27K	30K	35K	40K	57K	65K
LUMENS PER FOOT (lm/ft)	171	256	311	349	360	380	410	288	265	211	352	452	513	526	554	543	319	289
LUMENS PER WATT (lm/w)	63	56	71	82	85	87	98	98	111	63	91	73	86	86	90	93	92	96
CRI	91+	93+	94+	94+	95+	96+	97+	92+	89+	93+	95+	96+	97+	97+	98+	97+	95+	92+
Duv	-0.004	-0.0012	-0.0034	-0.0058	-0.0055	-0.0033	-0.0014	-0.0049	-0.0063	-0.003	0.0002	0.003	0.003	0.003	0.0009	0	0.003	0.003
Rf	91	93	94	94	95	94	94	92	90	92	93	95	95	95	95	94	92	91
Rg	105	101	103	105	104	102	100	102	103	104	100	102	103	103	101	100	102	103
R9	90	90	90	94	97	97	91	81	70	91	90	90	94	95	93	93	79	67
R13	92	94	95	95	94	96	99	90	87	92	95	96	96	97	99	99	91	88
R15	99	99	99	98	97	97	97	89	85	99	99	99	99	99	98	97	90	85
WIZ PRO WATTS/FOOT	2.7	4.55	4.35	4.25	4.25	4.35	4.2	2.95	2.4	3.35	3.85	6.15	5.95	6.15	6.15	5.84	3.45	3

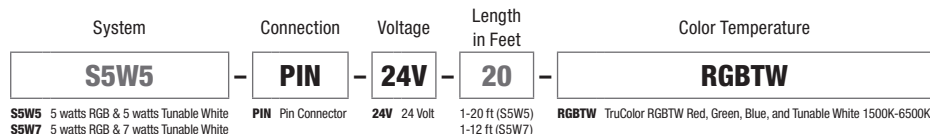

PROJECT		FIXTURE TYPE		DATE	
---------	--	--------------	--	------	--

TRUCOLOR™ RGB & TUNABLE WHITE LED STRIP

24VDC, 5 CHANNEL CONTROL

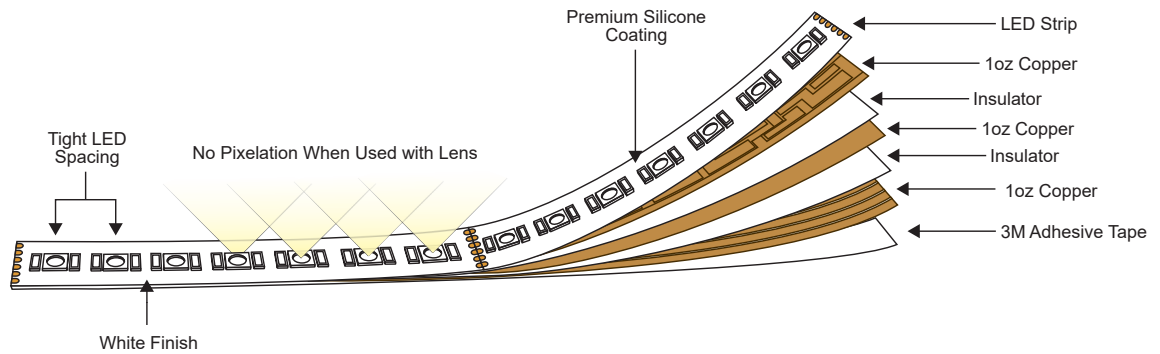

PIN CONNECTOR

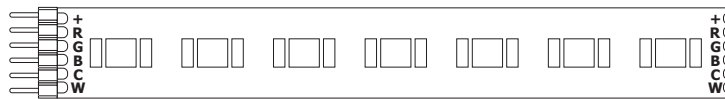

S5W5 WATTS PER FOOT			
LENGTH IN FEET	RGB Wattage	Tunable White Wattage	Pure Smart™ WIZ Pro Wattage
1	5	5	5
2	10	10	10
3	15	15	15
4	20	20	20
5	25	25	25
6	30	30	30
7	35	35	35
8	40	40	40
9	45	45	45
10	50	50	50
11	55	55	55
12	60	60	60
13	65	65	65
14	70	70	70
15	75	75	75
16	80	80	80
17	85	85	85
18	90	90	90
19	95	95	95
20	100	100	100

S5W7 WATTS PER FOOT			
LENGTH IN FEET	RGB Wattage	Tunable White Wattage	Pure Smart™ WIZ Pro Wattage
1	5	7	7
2	10	14	14
3	15	21	21
4	20	28	28
5	25	35	35
6	30	42	42
7	35	49	49
8	40	56	56
9	45	63	63
10	50	70	70
11	55	77	77
12	60	84	84

PROJECT		FIXTURE TYPE		DATE	
---------	--	--------------	--	------	--

SOFT STRIP, MONOCHROMATIC COLOR

24VDC WITH PIN CONNECTORS

DESIGNED BY GREGORY KAY | ASSEMBLED IN AMERICA | PATENT PENDING

REV 02.06.24



RRR - Red



BBB - Blue

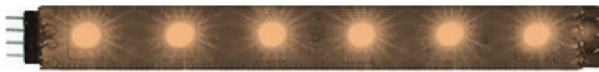

AAA - Amber

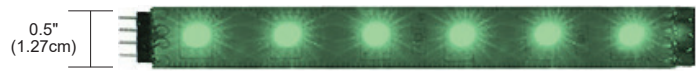

GGG - Green

4" (10.16cm)

DESCRIPTION

PureEdge Monochromatic Color Soft Strip provides dynamic color effects with monochromatic color LEDs. Offered in Red, Amber, Blue, and Green. The 1/2" wide flexible copper strip, with an optically clear protective coating, is sold in 1ft increments up to 36 ft with cutting increments every 4 inches. Self-adhering, our strip mounts to most smooth finished surfaces with the industrial strength 3M tape on the back. Our Soft Strip is used for our **DIY** (Do-it-Yourself) fixtures and systems. Includes 5 year warranty.

SPECIFICATIONS

- 24VDC, Class 2
- Power Consumption: 2.6 or 5 watts per foot
- Sold in 1' increments
- Field-cutttable in 4" increments
- Operating temperature: -22°F to 140°F (-30°C to 60°C)

MOUNTING

Industrial 3M tape lines back of strip for self-adhesion to most smooth finished surfaces Additional Connectors, Mounting Straps, and Clips may be needed for some applications (sold separately).

ACCESSORIES (SOLD SEPARATELY)

- 24VDC Power Connectors and Jumpers
- Flexible Connectors
- Mounting Straps & Clips

LAMP

- Monochromatic Red, Amber, Blue, and Green
- 18 LEDs per foot
- 50,000 Hour Lamp Life

MAXIMUM LENGTHS BEFORE RE-FEEDING

- 3WDC, 2.6 watts per foot - 36'
- 5WDC, 5 watts per foot - 20'

REMOTE POWER SUPPLIES*, DIMMING & CONTROLS (SOLD SEPARATELY)

24VDC, Class 2 wiring

- [Pure Smart™ WiZ Pro Power Supplies & Controls](#)
- [UNI Driver: Universal Dimming \(TRIAC, ELV, 0-10V\)](#)
- [Lutron Hi-Lume/Ecosystem](#)
- [DALI/ DALI 2](#)

*In-Wall Mounting Kits available for select power supplies

APPLICATIONS

Indoor and damp locations. Applications include coves, toe-kicks, under cabinets and shelving, bookcases, drawers, pathways, accent lighting, task lighting, and general illumination.

APPROVALS

Class 2 Wiring up to 100 watts, Indoor Damp Location Suitable, RoHS, ETL listed.

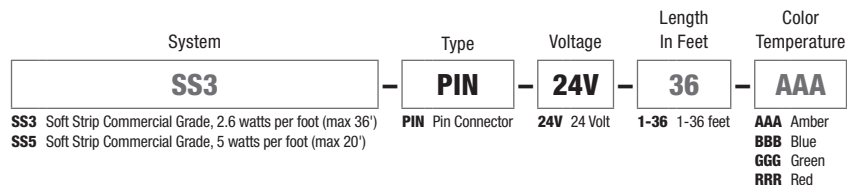

PROJECT	FIXTURE TYPE	DATE
---------	--------------	------

LIGHT CHANNEL 0.6" DIY RECESSED MILLWORK

24VDC, DO-IT-YOURSELF IN STATIC & TUNABLE WHITE, WARM DIM, RGB, MONOCHROMATIC COLOR & RGBTW

REV 02.12.24

LIGHT CHANNEL .6 RECESSED MILLWORK SYSTEM OVERVIEW

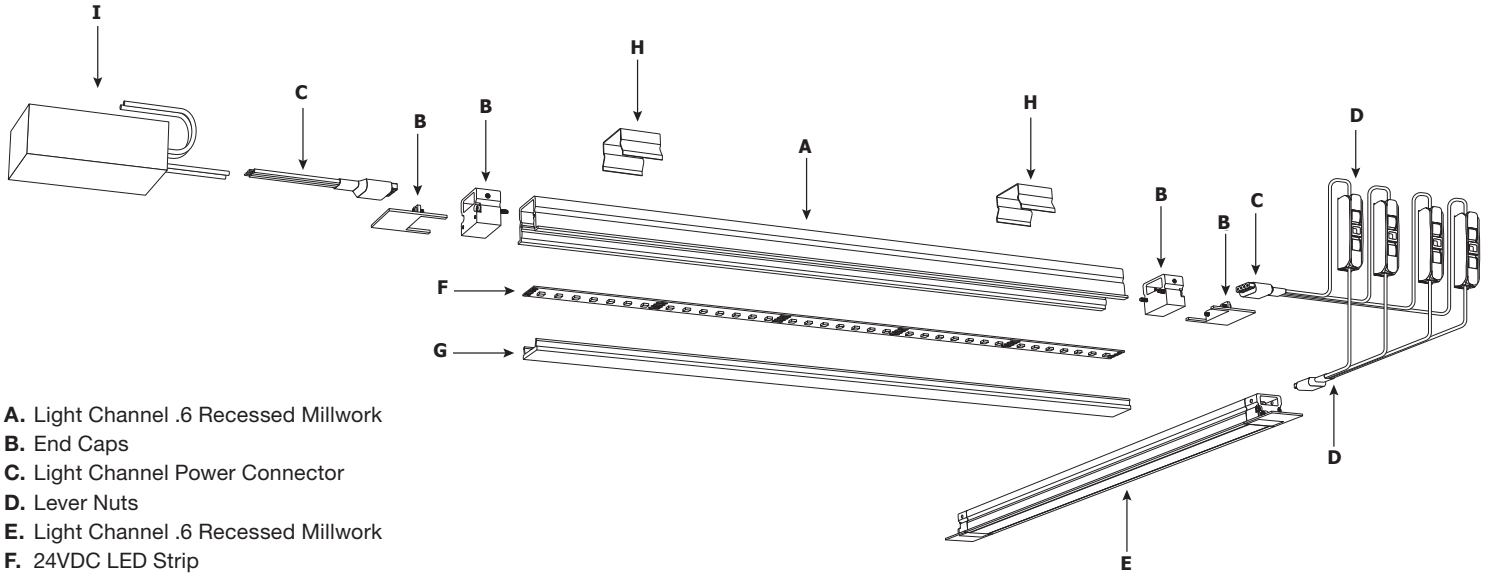

- A. Light Channel .6 Recessed Millwork
- B. End Caps
- C. Light Channel Power Connector
- D. Lever Nuts
- E. Light Channel .6 Recessed Millwork
- F. 24VDC LED Strip
- G. Lens
- H. Mounting Clips (Included Component with every 2' of channel)
- I. Remote Power Supply

DESCRIPTION	DIFFUSED LENS																
	STATIC WHITE					STATIC WHITE/WARM DIM						STATIC WHITE					
	2.5W					5W (4.4 watts)						7.3W					
WATTS PER FOOT																	
COLOR TEMPERATURE	24K	27K	30K	35K	40K	24K	27K	27D*	30K	30D*	35K	40K	24K	27K	30K	35K	40K
LUMENS PER FOOT (lm/ft)	120	121	127	145	153	222	225	256	234	267	268	283	343	347	361	415	437
LUMENS PER WATT (lm/w)	48	49	51	58	61	51	51	53	53	56	61	64	47	48	49	57	60
CRI	90+	95+	95+	85+	85+	90+	95+	92+	95+	92+	85+	85+	90+	95+	95+	85+	85+

*27D, 30D - Warm Dim (4.8 Watts)

DESCRIPTION	CLEAR FROSTED LENS																
	STATIC WHITE					STATIC WHITE/WARM DIM						STATIC WHITE					
	2.5W					5W (4.4 watts)						7.3W					
WATTS PER FOOT																	
COLOR TEMPERATURE	24K	27K	30K	35K	40K	24K	27K	27D*	30K	30D*	35K	40K	24K	27K	30K	35K	40K
LUMENS PER FOOT (lm/ft)	141	142	148	170	179	260	263	300	274	313	315	332	402	407	423	486	512
LUMENS PER WATT (lm/w)	56	57	59	68	72	59	60	63	62	65	71	75	55	56	58	67	70
CRI	90+	95+	95+	85+	85+	90+	95+	92+	95+	92+	85+	85+	90+	95+	95+	85+	85+

*27D, 30D - Warm Dim (4.8 Watts)

DESCRIPTION	WHITE LOUVRE CLEAR FROSTED																
	STATIC WHITE					STATIC WHITE/WARM DIM						STATIC WHITE					
	2.5W					5W (4.4 watts)						7.3W					
WATTS PER FOOT																	
COLOR TEMPERATURE	24K	27K	30K	35K	40K	24K	27K	27D*	30K	30D*	35K	40K	24K	27K	30K	35K	40K
LUMENS PER FOOT (lm/ft)	94	95	99	113	120	174	175	200	183	209	210	221	268	271	282	324	342
LUMENS PER WATT (lm/w)	38	38	40	45	48	39	40	42	42	43	48	50	37	37	39	44	47
CRI	90+	95+	95+	85+	85+	90+	95+	92+	95+	92+	85+	85+	90+	95+	95+	85+	85+

*27D, 30D - Warm Dim (4.8 Watts)

DESCRIPTION	WHITE LOUVRE DIFFUSED																
	STATIC WHITE					STATIC WHITE/WARM DIM						STATIC WHITE					
	2.5W					5W (4.4 watts)						7.3W					
WATTS PER FOOT																	
COLOR TEMPERATURE	24K	27K	30K	35K	40K	24K	27K	27D*	30K	30D*	35K	40K	24K	27K	30K	35K	40K
LUMENS PER FOOT (lm/ft)	80	81	84	97	102	148	150	171	156	178	179	189	229	231	241	276	291
LUMENS PER WATT (lm/w)	32	32	34	39	41	34	34	36	35	37	41	43	31	32	33	38	40
CRI	90+	95+	95+	85+	85+	90+	95+	92+	95+	92+	85+	85+	90+	95+	95+	85+	85+

*27D, 30D - Warm Dim (4.8 Watts)

DESCRIPTION	BLACK LOUVRE CLEAR FROSTED																
	STATIC WHITE					STATIC WHITE/WARM DIM						STATIC WHITE					
	2.5W					5W (4.4 watts)						7.3W					
WATTS PER FOOT																	
COLOR TEMPERATURE	24K	27K	30K	35K	40K	24K	27K	27D*	30K	30D*	35K	40K	24K	27K	30K	35K	40K
LUMENS PER FOOT (lm/ft)	53	54	56	64	68	99	100	114	104	118	119	125	152	154	160	184	194
LUMENS PER WATT (lm/w)	21	22	22	26	27	22	23	24	24	25	27	29	21	21	22	25	27
CRI	90+	95+	95+	85+	85+	90+	95+	92+	95+	92+	85+	85+	90+	95+	95+	85+	85+

*27D, 30D - Warm Dim (4.8 Watts)

PROJECT		FIXTURE TYPE		DATE	
---------	--	--------------	--	------	--

LIGHT CHANNEL 0.6" DIY RECESSED MILLWORK

24VDC, DO-IT-YOURSELF IN STATIC & TUNABLE WHITE, WARM DIM, RGB, MONOCHROMATIC COLOR & RGBTW

REV 02.12.24

DESCRIPTION	BLACK LOUVRE DIFFUSED																
	STATIC WHITE					STATIC WHITE/WARM DIM					STATIC WHITE						
	2.5W					5W (4.4 watts)					7.3W						
WATTS PER FOOT																	
COLOR TEMPERATURE	24K	27K	30K	35K	40K	24K	27K	27D*	30K	30D*	35K	40K	24K	27K	30K	35K	40K
LUMENS PER FOOT (lm/ft)	45	46	48	55	58	84	85	97	88	101	102	107	130	131	137	157	165
LUMENS PER WATT (lm/w)	18	18	19	22	23	19	19	20	20	21	23	24	18	18	19	21	23
CRI	90+	95+	95+	85+	85+	90+	95+	92+	95+	92+	85+	85+	90+	95+	95+	85+	85+

*27D, 30D - Warm Dim (4.8 Watts)

DESCRIPTION	DIFFUSED LENS																										
	2K6K					2K6K					2K6K																
	2W (2.5 watts)					5W (4.6 watts)					7W (7.3 watts)																
WATTS PER FOOT																											
COLOR TEMPERATURE	20K	22K	24K	27K	30K	35K	40K	57K	65K	20K	22K	24K	27K	30K	35K	40K	57K	65K	20K	22K	24K	27K	30K	35K	40K	57K	65K
LUMENS PER FOOT (lm/ft)	64	65	66	67	80	76	82	88	156	162	168	175	181	194	208	210	212	217	227	237	247	257	278	292	295	298	
LUMENS PER WATT (lm/w)	35	33	33	33	34	35	90	41	49	34	34	35	36	38	40	43	44	46	34	31	33	34	36	39	41	41	47
CRI	91+	91+	91+	91+	91+	94+	94+	94+	91+	91+	91+	91+	91+	91+	94+	94+	94+	91+	91+	91+	91+	91+	94+	94+	94+	91+	

DESCRIPTION	CLEAR FROSTED LENS																										
	2K6K					2K6K					2K6K																
	2W (2.5 watts)					5W (4.6 watts)					7W (7.3 watts)																
WATTS PER FOOT																											
COLOR TEMPERATURE	20K	22K	24K	27K	30K	35K	40K	57K	65K	20K	22K	24K	27K	30K	35K	40K	57K	65K	20K	22K	24K	27K	30K	35K	40K	57K	65K
LUMENS PER FOOT (lm/ft)	75	76	77	79	80	82	89	96	103	182	190	197	205	212	227	243	246	248	254	266	278	290	301	325	343	346	350
LUMENS PER WATT (lm/w)	41	38	39	39	40	41	90	48	57	40	40	41	43	44	47	51	54	40	37	39	40	42	45	48	48	55	
CRI	91+	91+	91+	91+	91+	94+	94+	94+	91+	91+	91+	91+	91+	91+	94+	94+	94+	91+	91+	91+	91+	91+	94+	94+	94+	91+	

DESCRIPTION	WHITE LOUVRE CLEAR FROSTED																										
	2K6K					2K6K					2K6K																
	2W (2.5 watts)					5W (4.6 watts)					7W (7.3 watts)																
WATTS PER FOOT																											
COLOR TEMPERATURE	20K	22K	24K	27K	30K	35K	40K	57K	65K	20K	22K	24K	27K	30K	35K	40K	57K	65K	20K	22K	24K	27K	30K	35K	40K	57K	65K
LUMENS PER FOOT (lm/ft)	50	51	52	52	53	54	60	64	69	122	127	132	137	141	151	162	164	165	169	177	185	193	201	217	228	231	233
LUMENS PER WATT (lm/w)	27	25	26	26	27	27	90	32	38	26	26	27	28	29	32	34	36	26	25	26	27	28	30	32	32	36	
CRI	91+	91+	91+	91+	91+	94+	94+	94+	91+	91+	91+	91+	91+	91+	94+	94+	94+	91+	91+	91+	91+	91+	94+	94+	94+	91+	

DESCRIPTION	WHITE LOUVRE DIFFUSED																										
	2K6K					2K6K					2K6K																
	2W (2.5 watts)					5W (4.6 watts)					7W (7.3 watts)																
WATTS PER FOOT																											
COLOR TEMPERATURE	20K	22K	24K	27K	30K	35K	40K	57K	65K	20K	22K	24K	27K	30K	35K	40K	57K	65K	20K	22K	24K	27K	30K	35K	40K	57K	65K
LUMENS PER FOOT (lm/ft)	43	43	44	45	45	46	51	55	59	104	108	112	116	121	129	138	140	141	144	151	158	165	171	185	195	197	199
LUMENS PER WATT (lm/w)	23	22	22	22	23	23	90	27	33	23	23	23	24	25	27	29	29	31	23	21	22	23	24	26	27	31	
CRI	91+	91+	91+	91+	91+	94+	94+	94+	91+	91+	91+	91+	91+	91+	94+	94+	94+	91+	91+	91+	91+	91+	94+	94+	94+	91+	

DESCRIPTION	BLACK LOUVRE CLEAR FROSTED																										
	2K6K					2K6K					2K6K																
	2W (2.5 watts)					5W (4.6 watts)					7W (7.3 watts)																
WATTS PER FOOT																											
COLOR TEMPERATURE	20K	22K	24K	27K	30K	35K	40K	57K	65K	20K	22K	24K	27K	30K	35K	40K	57K	65K	20K	22K	24K	27K	30K	35K	40K	57K	65K
LUMENS PER FOOT (lm/ft)	29	29	29	30	30	31	34	36	39	69	72	75	77	80	86	92	93	94	96	101	105	110	114	123	130	131	132
LUMENS PER WATT (lm/w)	15	14	15	15	15	15	90	18	22	15	15	16	16	17	18	19	19	20	15	14	15	15	16	17	18	21	
CRI	91+	91+	91+	91+	91+	94+	94+	94+	91+	91+	91+	91+	91+	91+	94+	94+	94+	91+	91+	91+	91+	91+	94+	94+	94+	91+	

DESCRIPTION	BLACK LOUVRE DIFFUSED																										
	2K6K					2K6K					2K6K																
	2W (2.5 watts)					5W (4.6 watts)					7W (7.3 watts)																
WATTS PER FOOT																											
COLOR TEMPERATURE	20K	22K	24K	27K	30K	35K	40K	57K	65K	20K	22K	24K	27K	30K	35K	40K	57K	65K	20K	22K	24K	27K	30K	35K	40K	57K	65K
LUMENS PER FOOT (lm/ft)	24	25	25	25	26	26	29	31	33	59	61	64	66	68	73	79	79	80	82	86	90	93	97	105	111	112	113
LUMENS PER WATT (lm/w)	13	12	13	13	13	13	90	16	18	13	13	13	14	14	15	16	17	17	13	12	12	13	14	15	15	18	
CRI	91+	91+	91+	91+	91+	94+	94+	94+	91+	91+	91+	91+	91+	91+	94+	94+	94+	91+	91+	91+	91+	91+	94+	94+	94+	91+	

DESCRIPTION	DIFFUSED LENS																				
	27K6					27K6					27K6										
	2W (2.5 watts)					5W (4.6 watts)					7W (7.3 watts)										
WATTS PER FOOT																					
COLOR TEMPERATURE	27K	30K	35K	40K	45K	57K	65K	27K	30K	35K	40K	45K	57K	65K	27K	30K	35K	40K	45K	57K	65K
LUMENS PER FOOT (lm/ft)	70	83	85	87	95	102	98	218	225	231	238	229	226	219	254	260	270	279	276	274	273
LUMENS PER WATT (lm/w)	35	33	34	35	38	41	49	55	56	56	55	56	57	56	40	36	37	39	38	38	43
CRI	93+	93+	94+	94+	94+	93+	93+	93+	93+	94+	94+	94+	93+	93+	93+	93+	94+	94+	94+	93+	93+

PROJECT		FIXTURE TYPE		DATE	
---------	--	--------------	--	------	--

LIGHT CHANNEL 0.6" DIY RECESSED MILLWORK

24VDC, DO-IT-YOURSELF IN STATIC & TUNABLE WHITE, WARM DIM, RGB, MONOCHROMATIC COLOR & RGBTW

DESCRIPTION	CLEAR FROSTED LENS																				
	27K6							27K6							27K6						
	2W (2.5 watts)							5W (4.6 watts)							7W (7.3 watts)						
WATTS PER FOOT																					
COLOR TEMPERATURE	27K	30K	35K	40K	45K	57K	65K	27K	30K	35K	40K	45K	57K	65K	27K	30K	35K	40K	45K	57K	65K
LUMENS PER FOOT (lm/ft)	82	97	99	102	112	120	114	256	263	271	279	268	265	257	298	305	316	327	324	321	320
LUMENS PER WATT (lm/w)	41	39	40	41	45	48	57	64	66	66	65	65	66	65	47	42	44	45	45	45	50
CRI	93+	93+	94+	94+	94+	93+	93+	93+	93+	94+	94+	94+	93+	93+	93+	93+	94+	94+	94+	93+	93+

DESCRIPTION	WHITE LOUVRE CLEAR FROSTED																				
	27K6							27K6							27K6						
	2W (2.5 watts)							5W (4.6 watts)							7W (7.3 watts)						
WATTS PER FOOT																					
COLOR TEMPERATURE	27K	30K	35K	40K	45K	57K	65K	27K	30K	35K	40K	45K	57K	65K	27K	30K	35K	40K	45K	57K	65K
LUMENS PER FOOT (lm/ft)	54	65	66	68	74	80	76	171	176	181	186	179	177	171	199	203	211	218	216	214	213
LUMENS PER WATT (lm/w)	27	26	27	27	30	32	38	43	44	44	43	44	44	44	31	28	29	30	30	30	33
CRI	93+	93+	94+	94+	94+	93+	93+	93+	93+	94+	94+	94+	93+	93+	93+	93+	94+	94+	94+	93+	93+

DESCRIPTION	WHITE LOUVRE DIFFUSED																				
	27K6							27K6							27K6						
	2W (2.5 watts)							5W (4.6 watts)							7W (7.3 watts)						
WATTS PER FOOT																					
COLOR TEMPERATURE	27K	30K	35K	40K	45K	57K	65K	27K	30K	35K	40K	45K	57K	65K	27K	30K	35K	40K	45K	57K	65K
LUMENS PER FOOT (lm/ft)	46	55	57	58	63	68	65	146	150	154	159	153	151	146	169	173	180	186	184	183	182
LUMENS PER WATT (lm/w)	23	22	23	23	25	27	33	37	37	38	37	37	38	37	26	24	25	26	26	25	28
CRI	93+	93+	94+	94+	94+	93+	93+	93+	93+	94+	94+	94+	93+	93+	93+	93+	94+	94+	94+	93+	93+

DESCRIPTION	BLACK LOUVRE CLEAR FROSTED																				
	27K6							27K6							27K6						
	2W (2.5 watts)							5W (4.6 watts)							7W (7.3 watts)						
WATTS PER FOOT																					
COLOR TEMPERATURE	27K	30K	35K	40K	45K	57K	65K	27K	30K	35K	40K	45K	57K	65K	27K	30K	35K	40K	45K	57K	65K
LUMENS PER FOOT (lm/ft)	31	37	38	39	42	45	43	97	100	103	105	101	100	97	113	115	120	124	122	121	121
LUMENS PER WATT (lm/w)	15	15	15	15	17	18	22	24	25	25	25	25	25	25	18	16	17	17	17	17	19
CRI	93+	93+	94+	94+	94+	93+	93+	93+	93+	94+	94+	94+	93+	93+	93+	93+	94+	94+	94+	93+	93+

DESCRIPTION	BLACK LOUVRE DIFFUSED																				
	27K6							27K6							27K6						
	2W (2.5 watts)							5W (4.6 watts)							7W (7.3 watts)						
WATTS PER FOOT																					
COLOR TEMPERATURE	27K	30K	35K	40K	45K	57K	65K	27K	30K	35K	40K	45K	57K	65K	27K	30K	35K	40K	45K	57K	65K
LUMENS PER FOOT (lm/ft)	26	31	32	33	36	39	37	83	85	88	90	87	86	83	96	98	102	106	104	104	103
LUMENS PER WATT (lm/w)	13	12	13	13	14	16	18	21	21	21	21	21	21	21	15	14	14	15	15	14	16
CRI	93+	93+	94+	94+	94+	93+	93+	93+	93+	94+	94+	94+	93+	93+	93+	93+	94+	94+	94+	93+	93+

DESCRIPTION	DIFFUSED LENS																			
	5W5 5W RGB & 5W TUNABLE WHITE										5W7 5W RGB & 7W TUNABLE WHITE									
	5W Maximum										7W Maximum									
WATTS PER FOOT																				
COLOR TEMPERATURE	20K	22K	24K	27K	30K	35K	40K	57K	65K	20K	22K	24K	27K	30K	35K	40K	57K	65K		
LUMENS PER FOOT (lm/ft)	84	155	161	170	179	190	199	145	130	90	206	216	227	239	255	271	168	146		
LUMENS PER WATT (lm/w)	73	34	88	40	42	103	47	116	47	27	54	35	38	39	41	46	49	45		
CRI	93	94	95	93	96	96	94	93	93	93	94	96	95	96	96	94	93	93		
Duv	-0.0030	-0.0005	-0.0021	-0.0037	-0.0041	-0.0029	-0.0006	-0.0002	0.0000	-0.0030	0.0003	0.0020	0.0002	0.0001	0.0020	0.0025	0.0000	0.0076		
Rf	91	93	93	93	93	93	91	91	87	90	93	93	93	93	93	91	91	91		
Rg	93	98	101	102	102	100	99	100	96	99	98	101	102	102	100	98	100	99		
R9	79	64	69	75	78	76	69	95	95	79	75	68	74	76	76	68	94	95		
R13	92	94	95	95	94	96	99	90	87	92	95	96	96	97	99	99	91	88		
R15	99	99	99	98	97	97	97	89	85	99	99	99	99	99	98	97	90	85		
WATTS/FOOT	2.7	4.55	4.35	4.25	4.25	4.35	4.2	2.95	2.75	3.35	3.85	6.15	5.95	6.15	6.15	5.84	3.45	3.2		

DESCRIPTION	CLEAR FROSTED LENS																			
	5W5 5W RGB & 5W TUNABLE WHITE										5W7 5W RGB & 7W TUNABLE WHITE									
	5W Maximum										7W Maximum									
WATTS PER FOOT																				
COLOR TEMPERATURE	20K	22K	24K	27K	30K	35K	40K	57K	65K	20K	22K	24K	27K	30K	35K	40K	57K	65K		
LUMENS PER FOOT (lm/ft)	98	182	189	199	209	223	233	170	153	106	242	253	266	280	299	317	196	171		
LUMENS PER WATT (lm/w)	73	40	88	47	49	103	55	116	56	32	63	41	45	46	49	54	57	53		
CRI	93	94	95	93	96	96	94	93	93	93	94	96	95	96	96	94	93	93		
Duv	-0.0030	-0.0005	-0.0021	-0.0037	-0.0041	-0.0029	-0.0006	-0.0002	0.0000	-0.0030	0.0003	0.0020	0.0002	0.0001	0.0020	0.0025	0.0000	0.0076		
Rf	91	93	93	93	93	93	91	91	87	90	93	93	93	93	93	91	91	91		
Rg	93	98	101	102	102	100	99	100	96	99	98	101	102	102	100	98	100	99		
R9	79	64	69	75	78	76	69	95	95	79	75	68	74	76	76	68	94	95		
R13	92	94	95	95	94	96	99	90	87	92	95	96	96	97	99	99	91	88		
R15	99	99	99	98	97	97	97	89	85	99	99	99	99	99	98	97	90	85		
WATTS/FOOT	2.7	4.55	4.35	4.25	4.25	4.35	4.2	2.95	2.75	3.35	3.85	6.15	5.95	6.15	6.15	5.84	3.45	3.2		

PROJECT		FIXTURE TYPE		DATE	
---------	--	--------------	--	------	--

LIGHT CHANNEL 0.6" DIY RECESSED MILLWORK

24VDC, DO-IT-YOURSELF IN STATIC & TUNABLE WHITE, WARM DIM, RGB, MONOCHROMATIC COLOR & RGBTW

DESCRIPTION	WHITE LOUVRE CLEAR FROSTED																	
	5W5 5W RGB & 5W TUNABLE WHITE									5W7 5W RGB & 7W TUNABLE WHITE								
	5W Maximum									7W Maximum								
WATTS PER FOOT	20K	22K	24K	27K	30K	35K	40K	57K	65K	20K	22K	24K	27K	30K	35K	40K	57K	65K
COLOR TEMPERATURE	20K	22K	24K	27K	30K	35K	40K	57K	65K	20K	22K	24K	27K	30K	35K	40K	57K	65K
LUMENS PER FOOT (lm/ft)	65	121	126	133	139	149	155	113	102	70	161	169	178	187	199	212	131	114
LUMENS PER WATT (lm/w)	73	27	88	31	33	103	37	116	37	21	42	27	30	30	32	36	38	36
CRI	93	94	95	93	96	96	94	93	93	93	94	96	95	96	96	94	93	93
Duv	-0.0030	-0.0005	-0.0021	-0.0037	-0.0041	-0.0029	-0.0006	-0.0002	0.0000	-0.0030	0.0003	0.0020	0.0002	0.0001	0.0020	0.0025	0.0000	0.0076
Rf	91	93	93	93	93	93	91	91	87	90	93	93	93	93	93	91	91	91
Rg	93	98	101	102	102	100	99	100	96	99	98	101	102	102	100	98	100	99
R9	79	64	69	75	78	76	69	95	95	79	75	68	74	76	76	68	94	95
R13	92	94	95	95	94	96	99	90	87	92	94	95	95	94	96	99	90	87
R15	99	99	99	98	97	97	97	89	85	99	99	99	98	97	97	97	89	85
WATTS/FOOT	2.7	4.55	4.35	4.25	4.25	4.35	4.2	2.95	2.75	3.35	3.85	6.15	5.95	6.15	6.15	5.84	3.45	3.2

DESCRIPTION	WHITE LOUVRE DIFFUSED																	
	5W5 5W RGB & 5W TUNABLE WHITE									5W7 5W RGB & 7W TUNABLE WHITE								
	5W Maximum									7W Maximum								
WATTS PER FOOT	20K	22K	24K	27K	30K	35K	40K	57K	65K	20K	22K	24K	27K	30K	35K	40K	57K	65K
COLOR TEMPERATURE	20K	22K	24K	27K	30K	35K	40K	57K	65K	20K	22K	24K	27K	30K	35K	40K	57K	65K
LUMENS PER FOOT (lm/ft)	56	104	107	113	119	127	133	97	87	60	138	144	151	159	170	181	112	97
LUMENS PER WATT (lm/w)	73	23	88	27	28	103	32	116	32	18	36	23	25	26	28	31	32	30
CRI	93	94	95	93	96	96	94	93	93	93	94	96	95	96	96	94	93	93
Duv	-0.0030	-0.0005	-0.0021	-0.0037	-0.0041	-0.0029	-0.0006	-0.0002	0.0000	-0.0030	0.0003	0.0020	0.0002	0.0001	0.0020	0.0025	0.0000	0.0076
Rf	91	93	93	93	93	93	91	91	87	90	93	93	93	93	93	91	91	91
Rg	93	98	101	102	102	100	99	100	96	99	98	101	102	102	100	98	100	99
R9	79	64	69	75	78	76	69	95	95	79	75	68	74	76	76	68	94	95
R13	92	94	95	95	94	96	99	90	87	92	94	95	95	94	96	99	90	87
R15	99	99	99	98	97	97	97	89	85	99	99	99	98	97	97	97	89	85
WATTS/FOOT	2.7	4.55	4.35	4.25	4.25	4.35	4.2	2.95	2.75	3.35	3.85	6.15	5.95	6.15	6.15	5.84	3.45	3.2

DESCRIPTION	BLACK LOUVRE CLEAR FROSTED																	
	5W5 5W RGB & 5W TUNABLE WHITE									5W7 5W RGB & 7W TUNABLE WHITE								
	5W Maximum									7W Maximum								
WATTS PER FOOT	20K	22K	24K	27K	30K	35K	40K	57K	65K	20K	22K	24K	27K	30K	35K	40K	57K	65K
COLOR TEMPERATURE	20K	22K	24K	27K	30K	35K	40K	57K	65K	20K	22K	24K	27K	30K	35K	40K	57K	65K
LUMENS PER FOOT (lm/ft)	37	69	71	75	79	84	88	64	58	40	92	96	101	106	113	120	74	65
LUMENS PER WATT (lm/w)	73	15	88	18	19	103	21	116	21	12	24	16	17	17	18	21	22	20
CRI	93	94	95	93	96	96	94	93	93	93	94	96	95	96	96	94	93	93
Duv	-0.0030	-0.0005	-0.0021	-0.0037	-0.0041	-0.0029	-0.0006	-0.0002	0.0000	-0.0030	0.0003	0.0020	0.0002	0.0001	0.0020	0.0025	0.0000	0.0076
Rf	91	93	93	93	93	93	91	91	87	90	93	93	93	93	93	91	91	91
Rg	93	98	101	102	102	100	99	100	96	99	98	101	102	102	100	98	100	99
R9	79	64	69	75	78	76	69	95	95	79	75	68	74	76	76	68	94	95
R13	92	94	95	95	94	96	99	90	87	92	95	96	96	97	99	99	91	88
R15	99	99	99	98	97	97	97	89	85	99	99	99	99	99	98	97	90	85
WATTS/FOOT	2.7	4.55	4.35	4.25	4.25	4.35	4.2	2.95	2.75	3.35	3.85	6.15	5.95	6.15	6.15	5.84	3.45	3.2

PROJECT		FIXTURE TYPE		DATE	
---------	--	--------------	--	------	--

LIGHT CHANNEL 0.6" DIY RECESSED MILLWORK

24VDC, DO-IT-YOURSELF IN STATIC & TUNABLE WHITE, WARM DIM, RGB, MONOCHROMATIC COLOR & RGBTW

REV 02.12.24

Indoor 24VDC LED Stomp Strip Compatible Channels: 24VDC LED Stomp Strips can be installed as a single strip or installed within a compatible channel with lens. See Light Channel spec sheets at www.pureedgelighting.com/product/cabinet_lighting_shelf_lighting/surface_mount.

- C Clear Lens
- D Diffused Lens
- L Linear Frost Lens
- G Gel Color Filter Suitable

SURFACE MOUNT LIGHT CHANNELS: Recommended applications* — Cove, pathway, toe-kick, undercabinet, and shelves

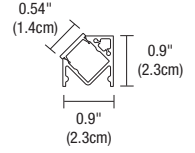
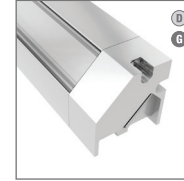
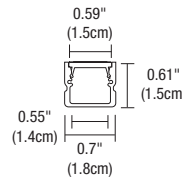
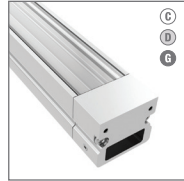
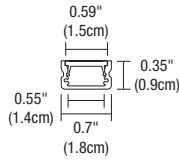

LCS.3 Light Channel

LCS.6 Light Channel

LC45 Light Channel 45°

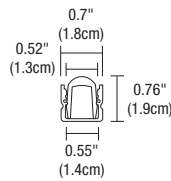

LCMG Light Channel Micro Grazer

RECESSED LIGHT CHANNELS: Recommended applications* (Recessed into drywall or wood)** — Coves, pathways, toe-kicks, undercabinets, and shelves

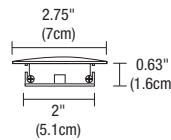
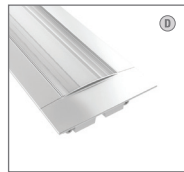
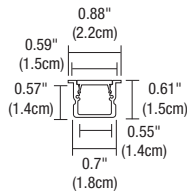

LCMW.6 Light Channel Millwork

LCT1.6 Light Channel Trim

Power Consumption per Linear Foot: Maximum length before refeeding

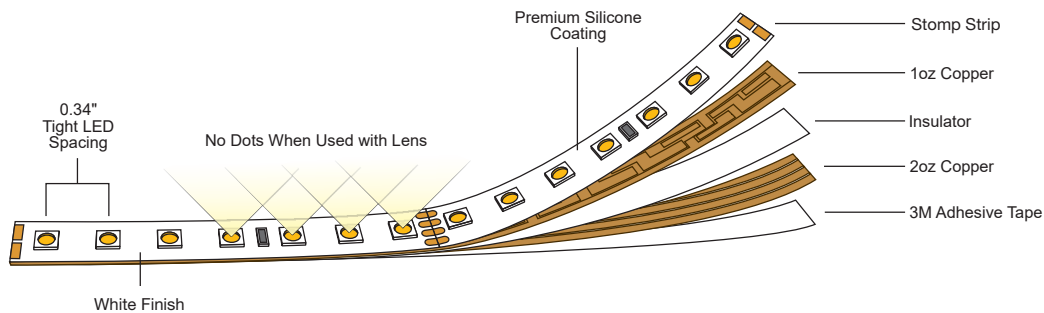

PROJECT	FIXTURE TYPE	DATE	
---------	--------------	------	--

LED STRIP TM30 DATA

(2.5W, 5W & 7W) 24VDC STATIC WHITE, WARM DIM & TUNABLE WHITE

TM-30-15 DATA: The data below is for bare LED Static White Strip. Consistent color temperatures throughout a single strip and among multiple strips is possible through a 3 phase binning process in which each order is inspected with a color meter to ensure uniformity.

2400K | Rf: 84.5 | Rg: 94.4

Color Vector Graphic

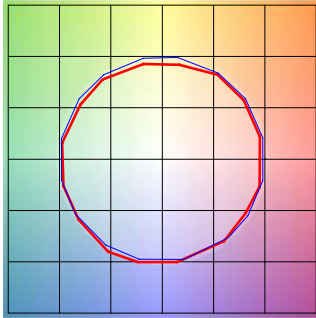

■ Test ■ Reference

HUE BIN	Rf	GRAPHIC SHIFTS %	
		CHROMA	HUE
1	92	-2.4%	1.5%
2	94.7	-2.1%	-0.0%
3	95.4	-1.9%	-0.1%
4	88.7	-6.7%	-3.1%
5	92.8	-5.6%	1.0%
6	92.7	-3.4%	3.4%
7	89.9	-4.3%	4.1%
8	92.4	-1.4%	4.4%
9	89	-0.6%	5.8%
10	88.9	0.4%	6.2%
11	89.7	4.0%	5.4%
12	92.6	3.0%	-0.7%
13	90.9	1.1%	-7.0%
14	89.9	0.5%	-5.8%
15	92.1	-3.2%	0.1%
16	88.9	-1.7%	-6.3%

2700K | Rf: 87.7 | Rg: 96.1

Color Vector Graphic

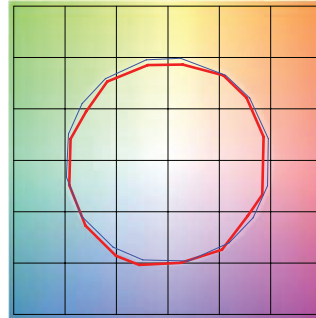

■ Test ■ Reference

HUE BIN	Rf	GRAPHIC SHIFTS %	
		CHROMA	HUE
1	88.0	-4.3%	2.6%
2	91.6	-2.4%	2.0%
3	93.7	-1.4%	1.9%
4	88.9	-5.6%	-3.1%
5	92.3	-5.5%	-0.5%
6	92.9	-3.5%	0.1%
7	84.5	-7.5%	4.6%
8	90.8	-3.0%	4.4%
9	84.5	-1.3%	8.3%
10	83.9	2.0%	9.8%
11	87.2	5.3%	7.1%
12	89.2	5.4%	-2.6%
13	88.7	0.3%	-7.8%
14	86.8	1.7%	-9.3%
15	87.6	-5.4%	-1.3%
16	83.6	-3.3%	-9.5%

3000K | Rf: 88.1 | Rg: 99.7

Color Vector Graphic

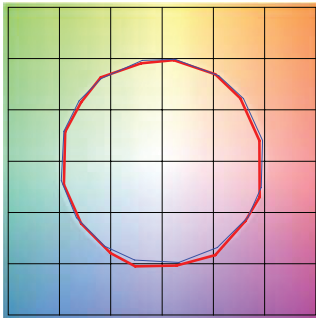

■ Test ■ Reference

HUE BIN	Rf	GRAPHIC SHIFTS %	
		CHROMA	HUE
1	92.5	-3.1%	0.3%
2	93.3	-2.3%	1.9%
3	90.9	-0.8%	3.9%
4	94.3	-1.1%	1.4%
5	92.5	-2.6%	1.5%
6	96.4	1.2%	-0.3%
7	92.6	-2.5%	-0.0%
8	96.9	-1.4%	0.2%
9	92.3	-1.8%	4.3%
10	86.6	-0.7%	7.0%
11	86.5	2.4%	8.2%
12	89.8	5.9%	1.7%
13	93.9	2.6%	-2.7%
14	89.4	5.1%	-5.8%
15	90.1	-0.1%	-4.7%
16	86.5	0.3%	-9.7%

3500K | Rf: 86.1 | Rg: 95.5

Color Vector Graphic

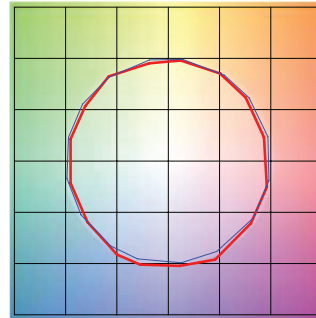

■ Test ■ Reference

HUE BIN	Rf	GRAPHIC SHIFTS %	
		CHROMA	HUE
1	90.8	-3.8%	0.3%
2	92.3	-2.8%	2.1%
3	89.7	-1.0%	4.3%
4	92.6	-1.4%	1.7%
5	91.8	-3.1%	1.3%
6	96.2	0.8%	-0.4%
7	92.9	-3.2%	0.2%
8	94.3	-2.5%	1.5%
9	90.4	-2.5%	5.2%
10	84.3	-1.4%	9.5%
11	83.1	3.5%	9.8%
12	88.2	4.8%	3.4%
13	94.0	2.7%	-2.0%
14	88.7	5.9%	-5.8%
15	88.7	0.7%	-5.9%
16	86.8	-0.7%	-6.7%

4000K | Rf: 87.6 | Rg: 96.8

Color Vector Graphic

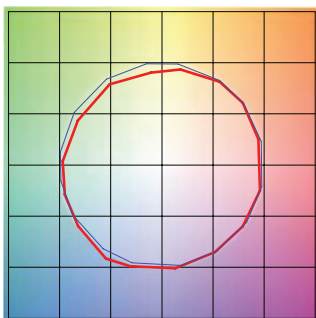

■ Test ■ Reference

HUE BIN	Rf	GRAPHIC SHIFTS %	
		CHROMA	HUE
1	88.9	-2.4%	2.5%
2	93.3	-0.4%	0.8%
3	94.8	-1.0%	-0.6%
4	87.9	-4.9%	-3.6%
5	85.3	-9.4%	-2.6%
6	90.2	-6.0%	0.2%
7	85.3	-7.6%	4.6%
8	83.7	-4.1%	8.2%
9	79.5	-1.1%	13.8%
10	78.6	1.5%	12.1%
11	83.5	6.4%	7.8%
12	90.9	3.6%	-1.1%
13	88.3	1.7%	-6.3%
14	91.9	-0.4%	-2.2%
15	84.5	-0.9%	-5.5%
16	84.7	-1.1%	-4.4%

PROJECT	FIXTURE TYPE	DATE
---------	--------------	------

LED STRIP TM30 DATA

(2.5W, 5W & 7W) 24VDC STATIC WHITE, WARM DIM & TUNABLE WHITE

TM-30-15 DATA: The data below is for bare LED Warm Dim Strip. Consistent color temperatures throughout a single strip and among multiple strips is possible through a 3 phase binning process in which each order is inspected with a color meter to ensure uniformity.

2700D | Rf: 90.7 | Rg: 101.1

Color Vector Graphic

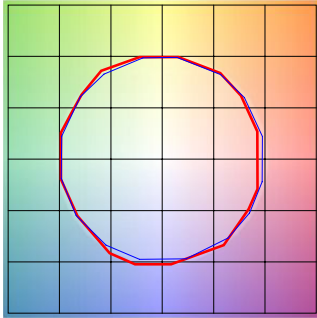

■ Test ■ Reference

HUE BIN	Rf	GRAPHIC SHIFTS %	
		CHROMA	HUE
1	90.9	-4.1%	1.1%
2	91.8	-2.2%	3.2%
3	89.0	0.2%	5.0%
4	92.9	-1.1%	0.8%
5	93.9	1.1%	1.7%
6	93.3	3.3%	0.0%
7	93.1	-0.5%	-1.9%
8	97.2	-0.3%	-0.9%
9	93.4	-1.0%	3.2%
10	89.9	-0.1%	5.6%
11	87.0	4.7%	7.2%
12	89.2	5.8%	-0.2%
13	89.1	3.5%	-6.7%
14	86.3	4.1%	-9.2%
15	91.4	-2.0%	-3.6%
16	84.7	-2.1%	-10.3%

3000D | Rf: 90.6 | Rg: 101.1

Color Vector Graphic

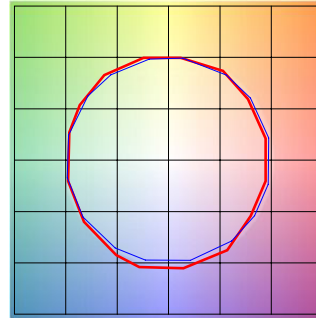

■ Test ■ Reference

HUE BIN	Rf	GRAPHIC SHIFTS %	
		CHROMA	HUE
1	91.5	-3.5%	1.3%
2	92.2	-1.8%	3.0%
3	89.3	0.5%	4.8%
4	92.7	-1.1%	0.6%
5	93.3	0.5%	1.4%
6	93.8	2.7%	-0.8%
7	91.2	-2.1%	-0.2%
8	97.0	-0.5%	-0.7%
9	92.5	-0.7%	3.8%
10	88.3	0.9%	7.1%
11	87.5	3.9%	7.6%
12	88.2	6.2%	-0.2%
13	89.9	3.4%	-6.0%
14	86.9	4.4%	-8.5%
15	91.9	-1.9%	-2.9%
16	84.7	-1.3%	-10.6%

PROJECT		FIXTURE TYPE		DATE	
---------	--	--------------	--	------	--

LED STRIP TM30 DATA

(2.5W, 5W & 7W) 24VDC STATIC WHITE, WARM DIM & TUNABLE WHITE

TM-30-15 DATA: The data below is for Tunable White bare LED Strip. Consistent color temperatures throughout a single strip and among multiple strips is possible through a 3 phase binning process in which each order is inspected with a color meter to ensure uniformity.

2000K ONLY (2K6K/27K6) | Rf: 90.6 | Rg: 98.5

Color Vector Graphic

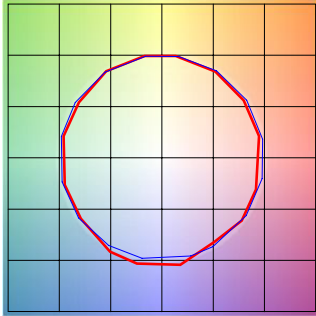

■ Test ■ Reference

HUE BIN	Rf	GRAPHIC SHIFTS %	
		CHROMA	HUE
1	87.7	-5.5%	1.2%
2	88.7	-3.9%	4.2%
3	90.5	-1.5%	4.3%
4	95.0	-1.7%	0.8%
5	95.2	-0.2%	2.1%
6	94.2	1.6%	1.9%
7	95.9	-0.8%	-2.2%
8	95.5	-1.7%	1.3%
9	93.8	-1.4	2.6%
10	91.9	-0.7%	4.2%
11	91.3	3.6%	3.7%
12	91.2	4.2%	-1.0%
13	86.6	3.8%	-12.7%
14	67.2	-3.0%	-16.3%
15	84.9	-3.3%	-9.4%
16	84.2	-5.7%	-7.5%

3000K (2K6K/27K6) | Rf: 90.5 | Rg: 100.7

Color Vector Graphic

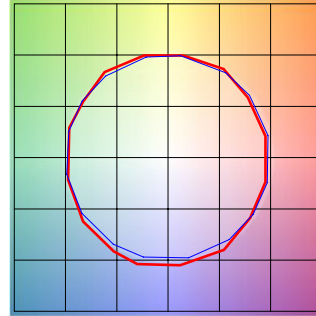

■ Test ■ Reference

HUE BIN	Rf	GRAPHIC SHIFTS %	
		CHROMA	HUE
1	91.5	-3.5%	1.2%
2	92.4	-1.8%	2.7%
3	89.8	0.3%	4.5%
4	92.4	-1.7%	0.4%
5	93.3	-0.1%	1.4%
6	94.5	2.1%	-0.6%
7	91.0	-2.5%	0.3%
8	96.9	-0.8%	-0.2%
9	91.6	-0.9%	4.6%
10	86.7	0.7%	7.8%
11	86.3	3.8%	8.5%
12	88.3	6.1%	0.6%
13	90.9	3.1%	-5.2%
14	87.3	4.7%	-7.9%
15	92.1	-1.9%	-2.5%
16	84.5	-0.9%	-10.9%

4000K ONLY (2K6K/27K6) | Rf: 86.4 | Rg: 96.1

Color Vector Graphic

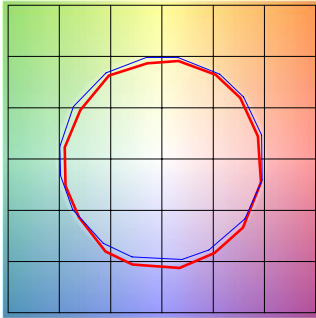

■ Test ■ Reference

HUE BIN	Rf	GRAPHIC SHIFTS %	
		CHROMA	HUE
1	86.5	-5.5%	1.3%
2	90.4	-3.0%	2.3%
3	89.8	-2.1%	3.6%
4	89.1	-3.4%	0.4%
5	88.5	-5.9%	0.1%
6	93.6	-3.0%	-0.4%
7	88.9	-6.2%	1.7%
8	87.3	-5.0%	4.9%
9	82.4	-3.6%	11.3%
10	77.4	-1.8%	12.7%
11	79.8	4.9%	11.4%
12	88.7	4.4%	2.7%
13	88.7	4.0%	-5.1%
14	91.2	2.2%	-3.8%
15	82.7	-0.1%	-9.2%
16	82.8	-2.2%	-7.6%

PROJECT		FIXTURE TYPE		DATE	
---------	--	--------------	--	------	--

LED STRIP TM30 DATA

(2.5W, 5W & 7W) 24VDC STATIC WHITE, WARM DIM & TUNABLE WHITE

TM-30-15 DATA: The data below is for TruColor™ RGBTW (S5W7) bare LED Strips. Consistent color temperatures throughout a single strip and among multiple strips is possible through a 3 phase binning process in which each order is inspected with a color meter to ensure uniformity.

2000K (TruColor™ RGBTW)

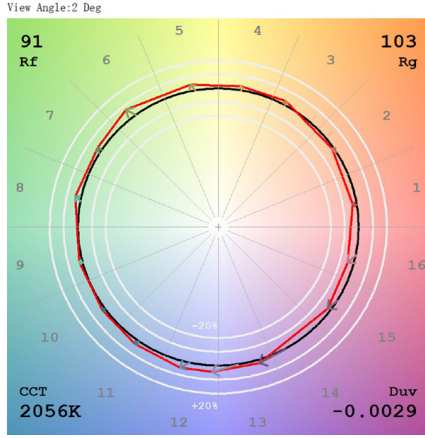

2200K (TruColor™ RGBTW)

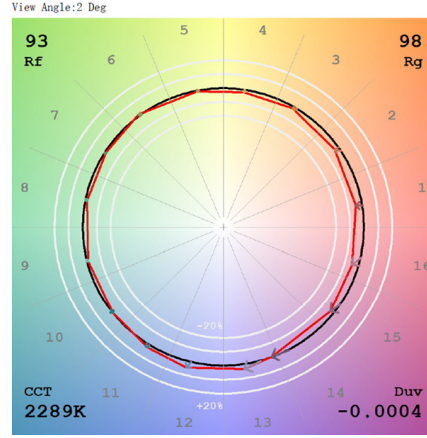

2400K (TruColor™ RGBTW)

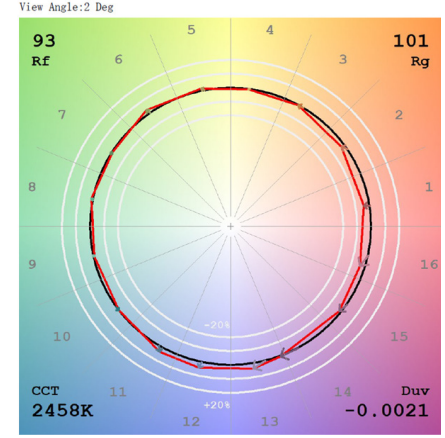

2700K (TruColor™ RGBTW)

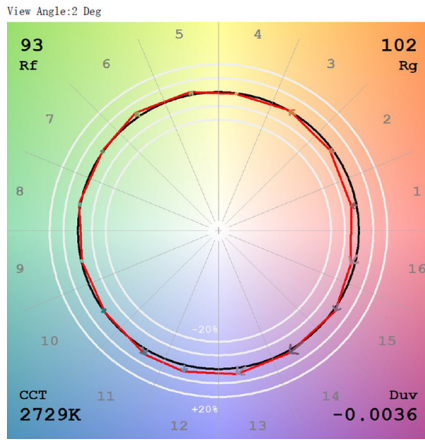

3000K (TruColor™ RGBTW)

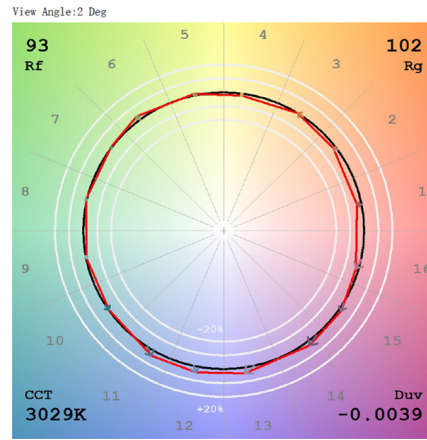

3500K (TruColor™ RGBTW)

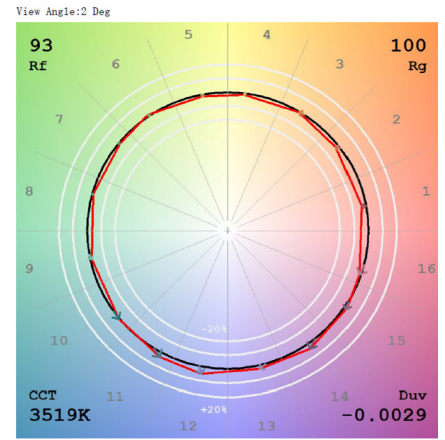

4000K (TruColor™ RGBTW)

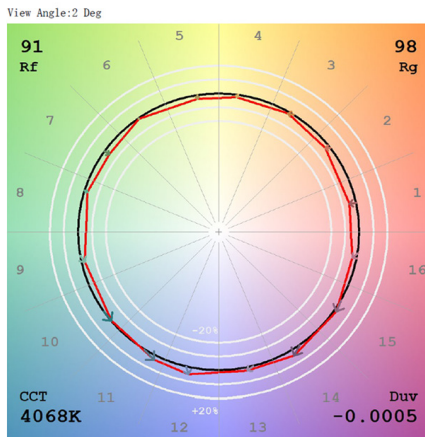

5700K (TruColor™ RGBTW)

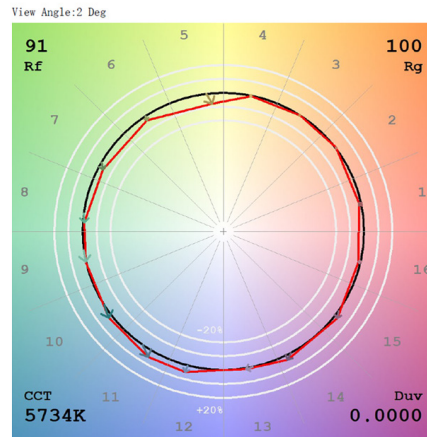

6500K (TruColor™ RGBTW)

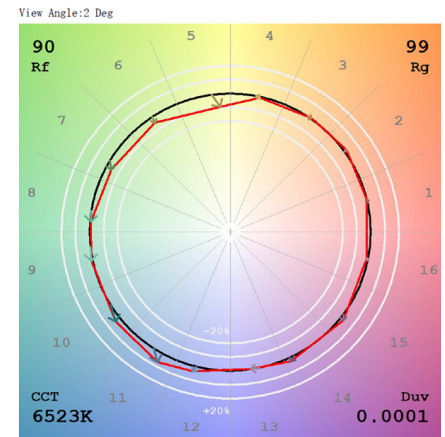

PROJECT		FIXTURE TYPE		DATE	
---------	--	--------------	--	------	--