

LUCA 3.5" STATIC WHITE

120V-277V, RECESSED WALL WASH DOWNLIGHTS

ASSEMBLED IN AMERICA | USA PATENT

REV 05.11.26

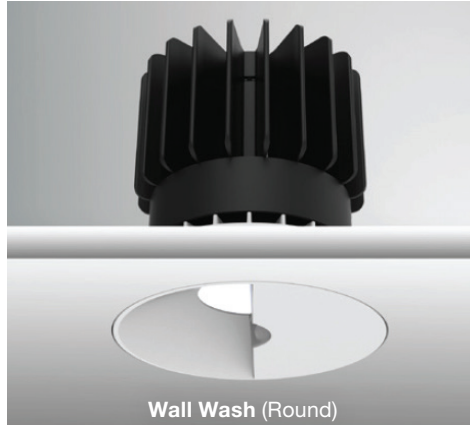
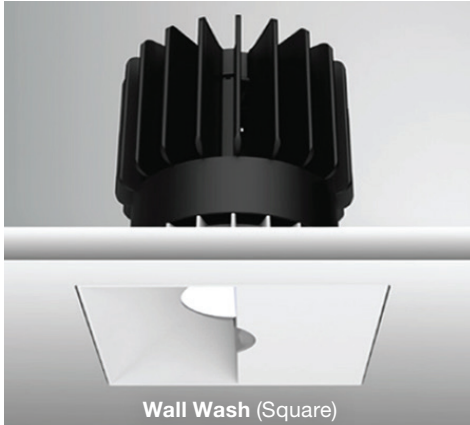

DESCRIPTION

Introducing Luca 3.5 "The Bringer of Light" Wall Wash Downlight series, a testament to the latest advancements in cutting-edge lighting technology, delivering high performance solutions designed to elevate hospitality, retail, commercial, and discerning residential spaces. Featuring precision optics, the Luca Wall Wash delivers a beam reaching the very top of the wall, creating an elegant wash of illumination. With a Color Rendering Index (CRI) surpassing 90, these lights ensure exceptional color accuracy, making it an ideal choice for spaces where ambiance and visual clarity are paramount.

The Luca Wall Wash Downlight series delivers captivating illumination across a wide spectrum, creating a visually engaging experience within any

space. With its extensive range of design and installation options, our Luca 3.5 Wall Wash Downlight is versatile for a wide array of new construction and remodel applications. Moreover, the compact form factor of the Luca 3.5 allows for installation in spaces with limited clearance.

Discover a new era of lighting performance and versatility with the Downlight and Wall Wash Series, where superior optics, lumen performance, and outstanding color consistency converge to transform a space. For personalized quotes and expert layout assistance, share your drawings and concepts with our design team at design@PureEdgeLighting.com

SPECIFICATIONS

TRIM OPTIONS	With Trim, Trimless, Round, Square				DIMMING Universal Dimming TRIAC/ELV: 100% – 3% 0-10V: 100% – 0.1% Dim to Off DALI2: 100% – 0.1% Dim to Off Pure Smart™ 100% – 5% Pure Smart™ Wi-Fi Dimmer TRIAC/ELV 2.4GHz Wi-Fi. No Hub needed. Voice control with Goggle Assistant, Alexa, Siri, Shortcuts, and IFTTT
ADJUSTABLE	360 Rotation				
BEAM ANGLE	Asymmetrical				
WATTAGE	16W	20W	24W	26W	
LUMENS @ 3000K, 30 Degrees	980Lm	1175Lm	1315Lm	1452Lm	
EFFICACY	61Lm/W	59Lm/W	55Lm/W	59Lm/W	
CCT	2400K, 2700K, 3000K, 3500K & 4000K				
CRI AVERAGE	90+				
INPUT VOLTAGE	120V ELV/TRIAC, 120V-277V & 0-10V & DALI				
CONSTRUCTION	Housing: Galvanized Steel Trims and Reflectors: Die-Cast Aluminum				
FINISH	Reflector: White, Black, Haze Silver (low-glare) Trims: White, Black (Select finish options for Reflector and Trim separately)				
EMERGENCY POWER	100W EM Power 120-277VAC				
CUT OUT SIZE	Round: Ø4", Square: 4"				
CEILING THICKNESS	0.5" - 1"				
ENVIRONMENT	Suitable for damp locations, Chicago Plenum				
CERTIFICATIONS	ETL Listed. Meets Title 24 (JA8) requirements.				
AVERAGE LIFE	50,000 Hours				
WARRANTY*	5 Years *See published warranty terms for detailed information				

NOMINAL LAMP DATA

WATTS	LUCA 3.5 STATIC WHITE															
	16W				20W				24W				26W			
COLOR TEMPERATURE	27K	30K	35K	40K	27K	30K	35K	40K	27K	30K	35K	40K	27K	30K	35K	40K
LUMENS	950	980	1163	1157	1128	1175	1222	1246	1263	1315	1368	1394	1481	1542	1604	1635
LUMENS PER WATT (lm/w)	16	16	16	16	20	20	20	20	24	24	24	24	26	26	26	26
CRI	93	93	93	93	92	92	92	92	92	92	92	92	90	90	90	90

LUCA 3.5" STATIC WHITE

120V-277V, RECESSED WALL WASH DOWNLIGHTS

REMODEL NON-IC (Included with Standard Ordering Code)

The standard ordering code serves both as a standalone option for remodeling and can also be utilized to incorporate new construction frames and housings.

System	Beam Spread	Color Temperature @ 90+ CRI	Trim Shape	Trim Function	Reflector Finish	Trim Type Finish
L35	WW	27K	R	W	W	L
L35 Luca 3.5 Light Engine	WW Wall Wash Asymmetrical Beam Spread	27K 2700K Incandescent White 30K 3000K Warm White 35K 3500K Neutral White 40K 4000K Cool White	R Round S Square	W Wall Wash	W White B Black H Haze C Custom	W White B Black L Trimless C Custom



LUCA 3.5 New Construction Frames and Housings

REMODEL NON-IC

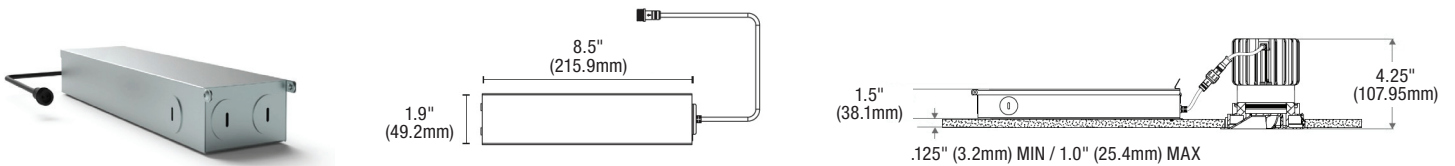

Product	Housing Type	Rating Type	Wattage/Lumens	Dimming
L35	RM	NIC	28W	UN
L35 Luca 3.5 Downlight	RM Remodel	NIC Non-Insulation Contact	16W 16 Watts/980 Lumens 20W 20 Watts/1175 Lumens 24W 24 Watts/1315 Lumens 26W 26 Watts/1542 Lumens	UN TRIAC/MLV, ELV 120V Input 01 0-10V 120V/277V Input DA DALI 2 120V/277V input

NEW CONSTRUCTION FRAME NON-IC

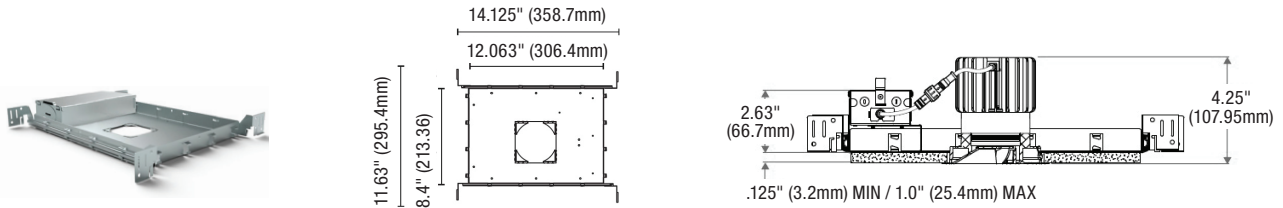

Product	Housing Type	Rating Type	Wattage/Lumens	Dimming
L35	NCF	NIC	28W	UN
L35 Luca 3.5 Downlight	NCF New Construction Frame	NIC Non-Insulation Contact	16W 16 Watts/980 Lumens 20W 20 Watts/1175 Lumens 24W 24 Watts/1315 Lumens 26W 26 Watts/1542 Lumens	UN TRIAC/MLV, ELV 120V Input 01 0-10V 120V/277V Input DA DALI 2 120V/277V input

New Construction Housing IC

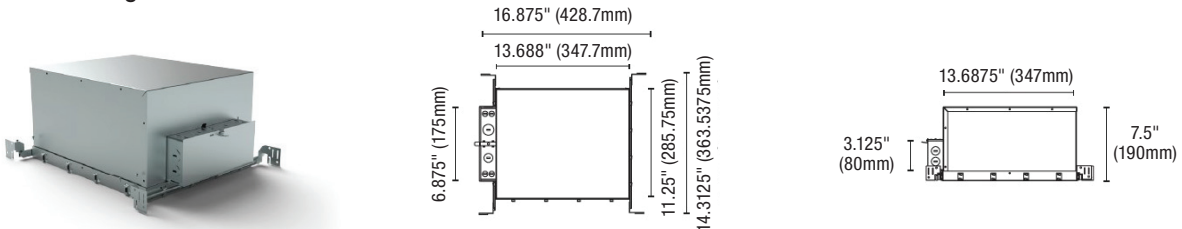

Product	Housing Type	Rating Type	Wattage/Lumens	Dimming
L35	NCH	IC	24W	UN
L35 Luca 3.5 Downlight	NCH New Construction Housing	IC Insulation Contact CP Chicago Plenum	16W 16 Watts/980 Lumens 20W 20 Watts/1175 Lumens 24W 24 Watts/1315 Lumens	UN TRIAC/MLV, ELV 120V Input 01 0-10V 120V/277V Input DA DALI 2 120V/277V input

LUCA 3.5" STATIC WHITE

120V-277V, RECESSED WALL WASH DOWNLIGHTS

LUCA 3.5 TRIMLESS HOUSING (INCLUDED WITH TRIM OPTION L)

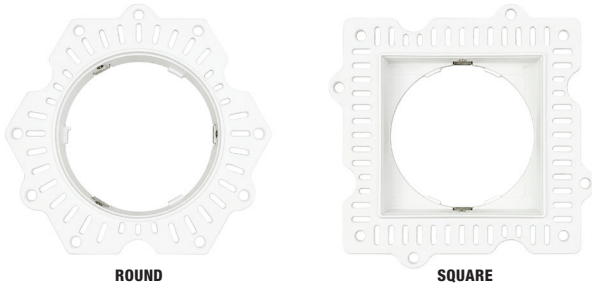

ROUND

SQUARE

Product	Housing Type	Trim Type	Finish
L27	RD	TL	WH
L27 Luca 2.7 Downlight	RD Round Square	TL Trimless	WH White

LUCA 3.5 MILLWORK TRIMLESS ADAPTER (INCLUDED WITH TRIM OPTION M)

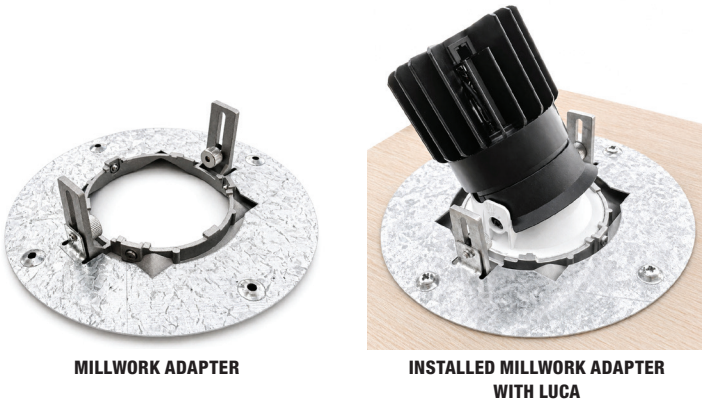

MILLWORK ADAPTER

INSTALLED MILLWORK ADAPTER WITH LUCA

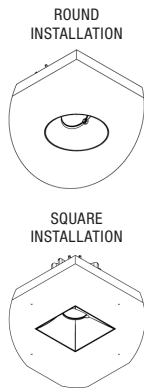

ROUND INSTALLATION

SQUARE INSTALLATION

Product	Housing Type	Trim Type	Type
L27	RDSQ	TL	M
L27 Luca 2.7 Downlight	RDSQ Round/Square	TL Trimless	M Wood Millwork

BEAM ANGLE/MILLWORK THICKNESS

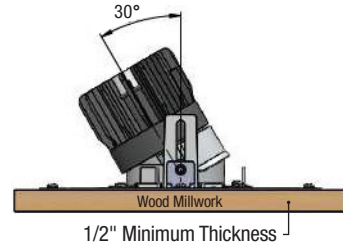

TRIMLESS ADAPTER INSTALLATION

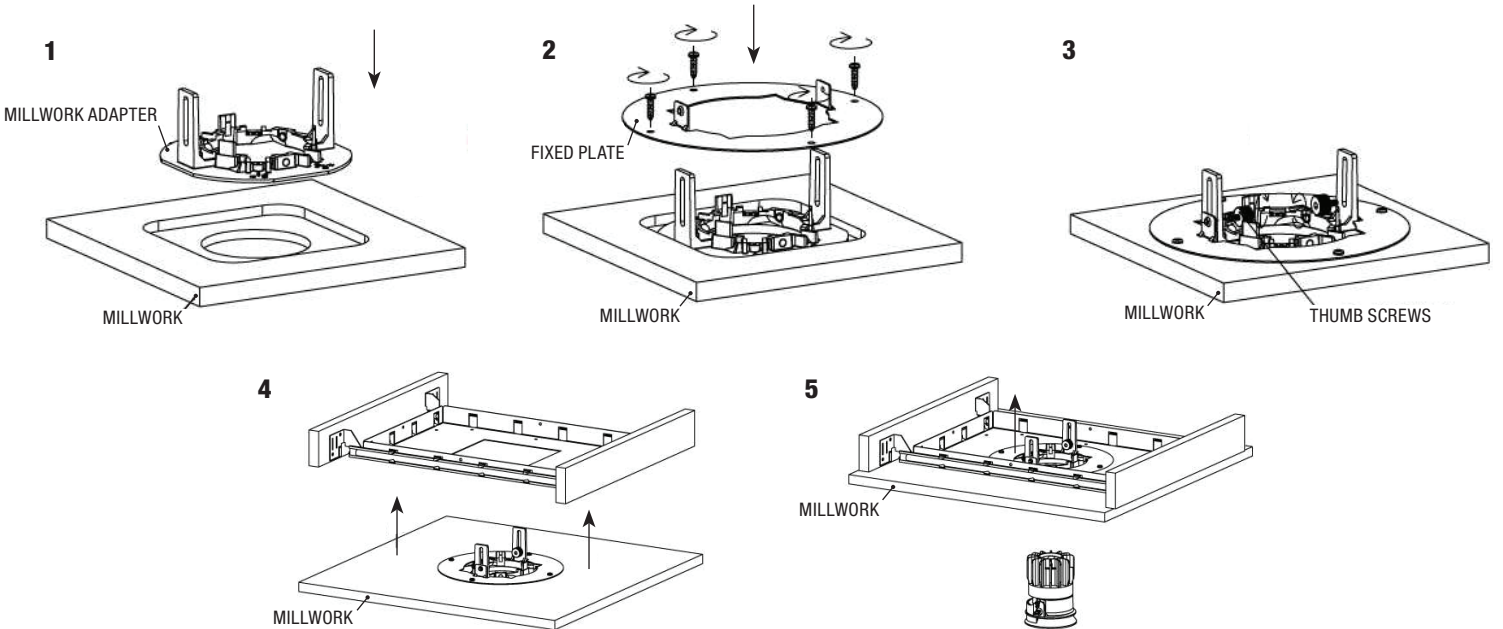

LUCA 3.5 WALL WASH TRIM OPTIONS

Wall Wash - Round



Round Trim

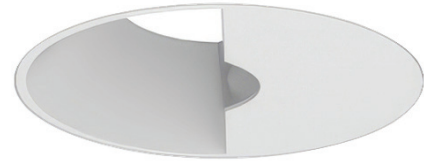
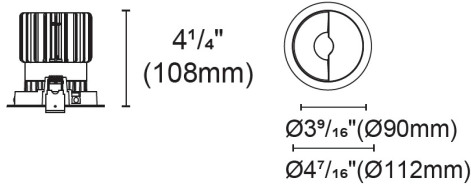

Round Trimless

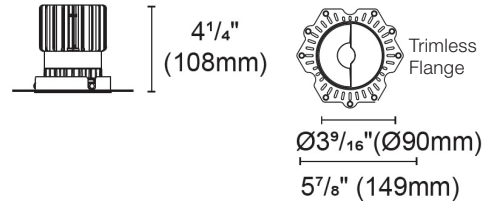

Wall Wash - Square



Square Trim

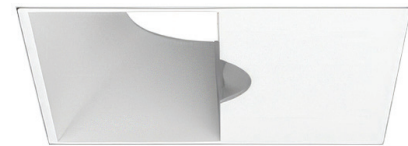
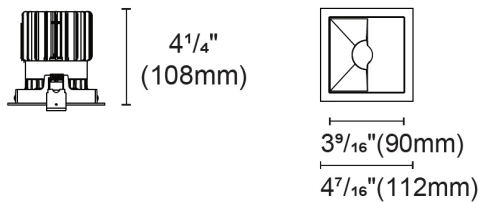

Square Trimless

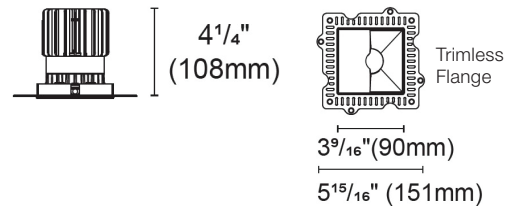

SINGLE LUCA 3.5 WALL WASH FOOT CANDLE DISTRIBUTION

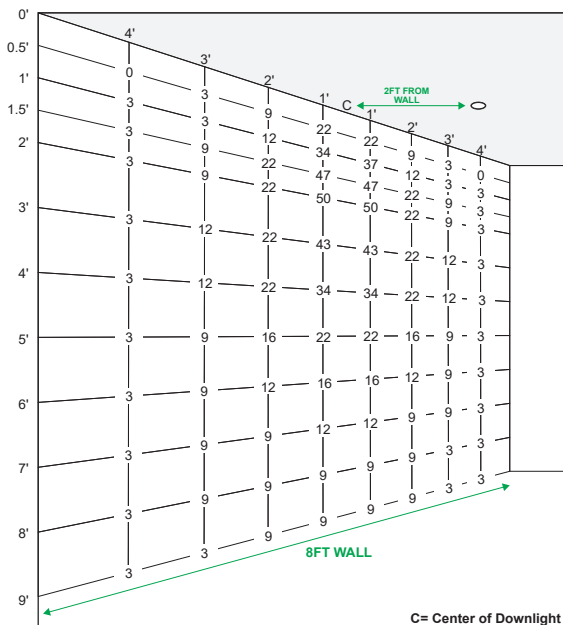

TWO LUCA 3.5 WALL WASH FOOT CANDLE DISTRIBUTION

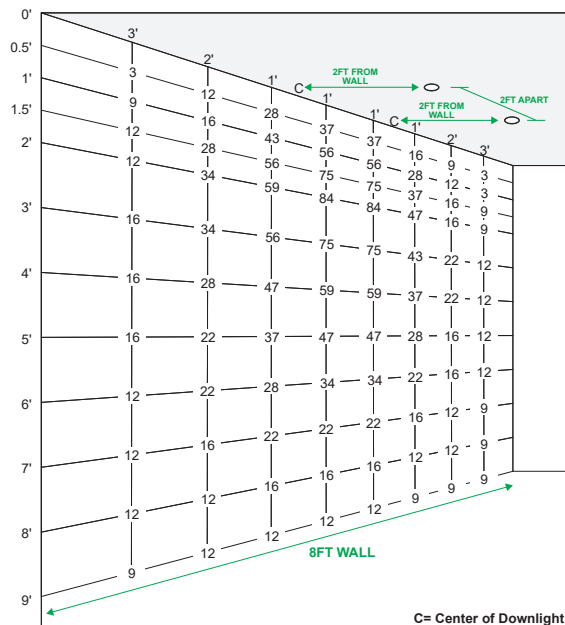

LUCA 3.5 TRIM & REFLECTOR OPTIONS

ROUND

Black Trim

White Trim

Trimless



Black Reflector with Black Cover

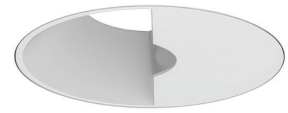

White Reflector with White Cover

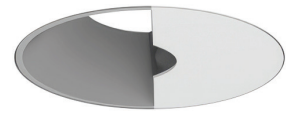
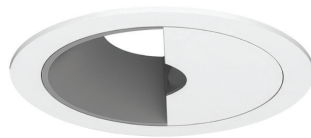

Haze Reflector with White Cover

SQUARE

Black Trim

White Trim

Trimless



Black Reflector with Black Cover



White Reflector with White Cover



Haze Reflector with White Cover

LUCA 3.5" STATIC WHITE
120V-277V, RECESSED WALL WASH DOWNLIGHTS

DISTANCE OUT AND BETWEEN CENTER OF FIXTURES (A)

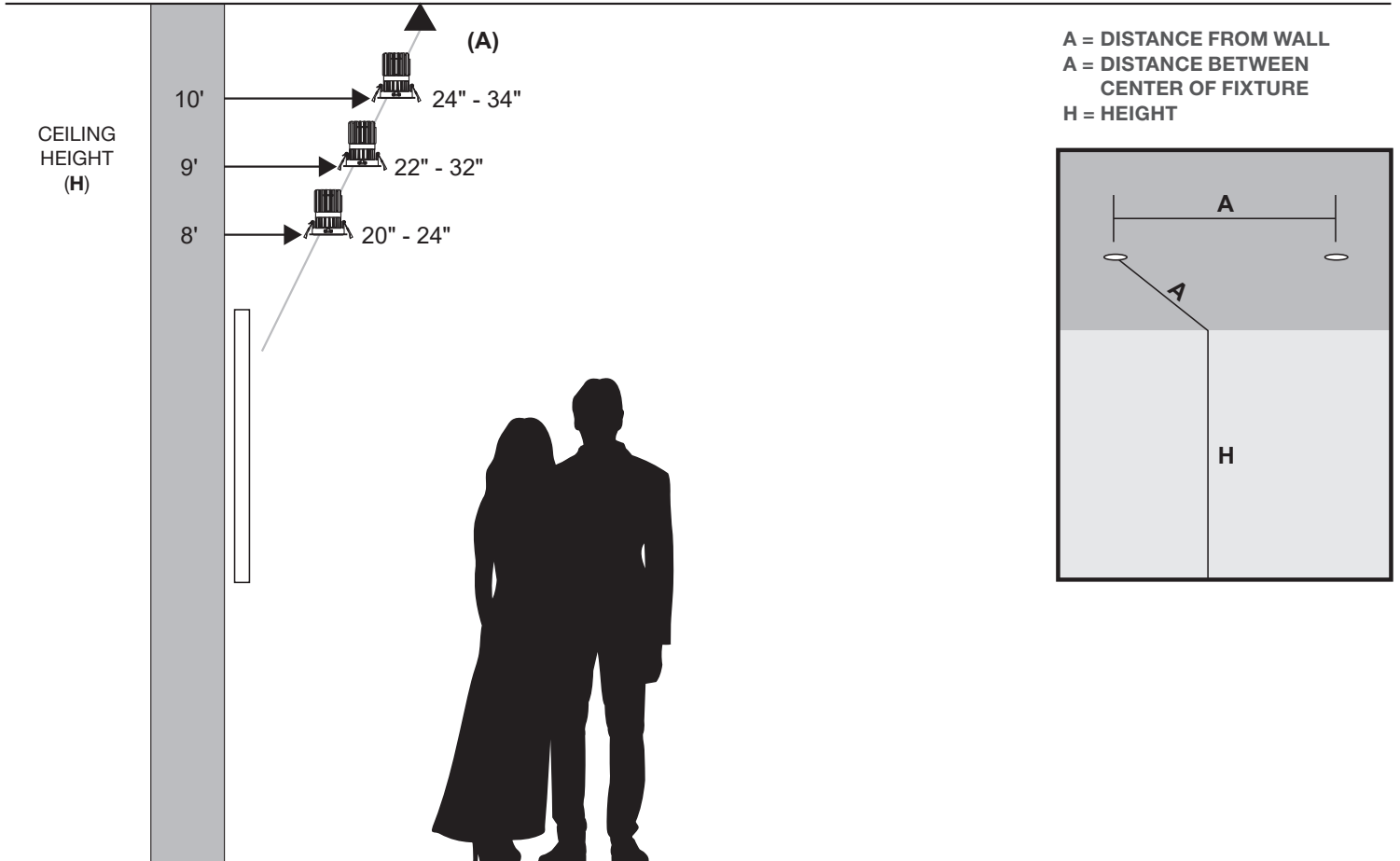

CANDLE POWER DISTRIBUTION

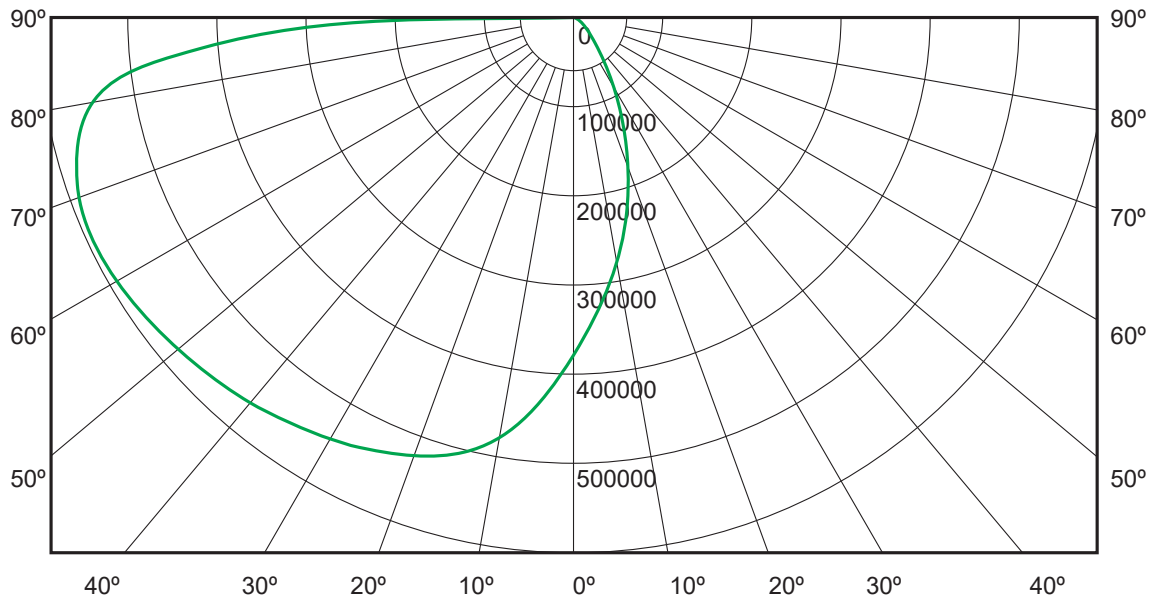

WIRING DIAGRAMS

TRIAC / FORWARD PHASE / LEADING EDGE DIMMING (TRI)
Input 120VAC 50/60Hz
Range 100% - 3%

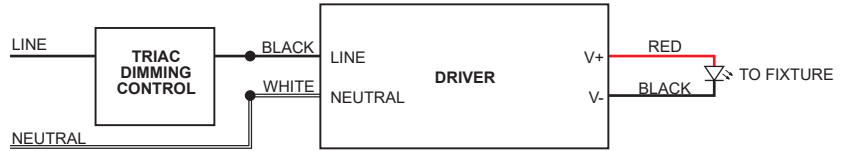

ELV / REVERSE PHASE / TRAILING EDGE DIMMING (TRI)
Input 120VAC 50/60Hz
Range 100% - 3%

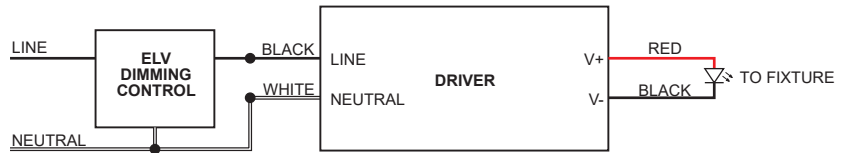

0-10V DIMMING (010)
Input 120VAC-277VAC 50/60Hz
Range 100% - 0.1% Dim to Off

NOTE
Cap off unused wires individually.
DO NOT cap together.

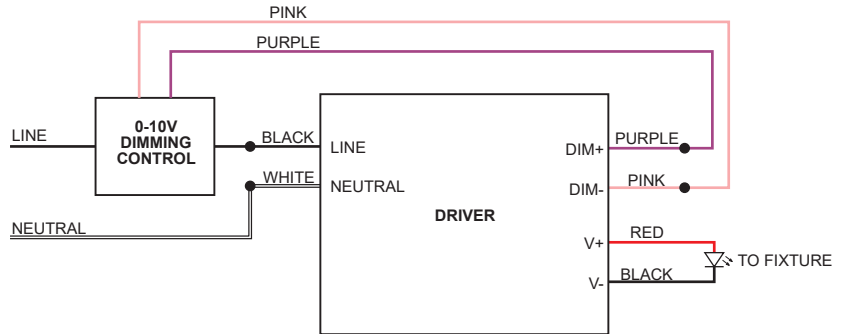

DALI DIMMING (DAL)
Input 120VAC-277VAC 50/60Hz
Range 100% - 0.1% Dim to Off

NOTE
Cap off unused wires individually.
DO NOT cap together.

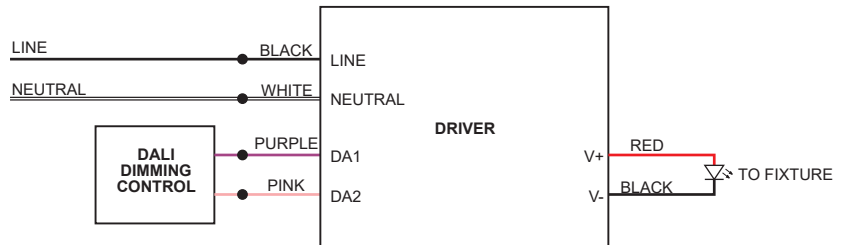

LUCA 3.5" STATIC WHITE

120V-277V, RECESSED WALL WASH DOWNLIGHTS

LUCA 3.5 DIMMING & CONTROLS



DESCRIPTION

The Pure Smart™ Wi-Fi dimmer works with non-smart bulbs and fixtures compatible with forward phase or Triac dimming (not compatible with 0-10V Dimming). Smart Wi-Fi Dimmer also allows for scheduling, grouping, voice control and control from anywhere via the WiZ app on your mobile device or the WiZ Pro Dashboard on your desktop.

OPERATION*

Features an ON/OFF switch and dimming functionality activated with a long press of the On (Brightness Up) or Off (Brightness Down) button. 400W Maximum Incandescent load, 150W CFL and/or retrofit LED bulb. Minimum trim and fade in/out settings are adjusted in the WiZ App. Communicates over 2.4 GHz Wi-Fi only. If remote power is being used, this dimmer is only compatible with PureEdge Universal Power Supplies. No Hub Required.

*When dimming traditional CFL/LEDs, ensure they are marked as dimmable.

BODY

Durable polycarbonate body. Compatible with decorator style wall plate (Not Included)

EASY INSTALLATION

The Pure Smart™ Wi-Fi Dimmer installs just like a regular in-wall switch. Works with any non-smart Static CCT or Warm Dim bulb/fixture compatible with forward phase or Triac dimming. Can be used in 3-way applications (Reference Manual for Wiring Diagram). Compatible with standard gangable boxes. Requires neutral wire. No Hub Required.

WiZ APP

The Pure Smart™ Dimmer can be controlled via the WiZ app (works with iOS and Android) from anywhere. Voice control enabled when used in conjunction with Google Assistant, Siri, Alexa, IFTTT, and SmartThings. Grouping, zoning, and scheduling can all be programmed with the WiZ app or WiZ Pro Dashboard.

SECURITY

3rd party log-in and cloud security provide a safe and protected connection. WiZ does not store nor share any personal information.

Product	Type	Finish
SWW	DIM	WH
SWW Pure Smart Wall WIZ Pro Connected	DIM Dimmer	WH White

NETWORK TOPOLOGY

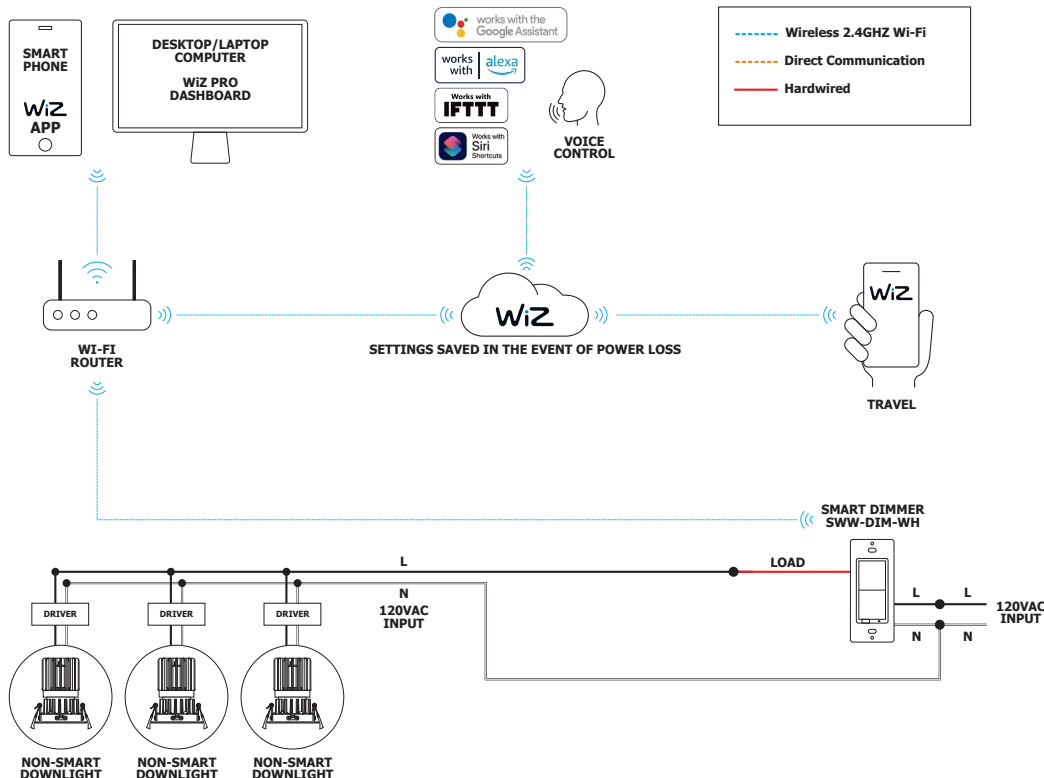

TM30 DATA

120V-277V, RECESSED WALL WASH DOWNLIGHTS

TM-30-15 DATA

2400K | Rf: 91.2 | Rg: 96.8
Color Vector Graphic

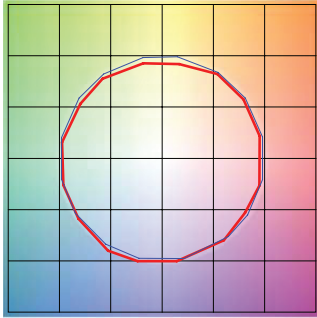

■ Test ■ Reference

		GRAPHIC SHIFTS %	
HUE BIN	Rf	CHROMA	HUE
1	92.0	-2.4%	1.5%
2	94.7	-2.1%	0.0%
3	95.4	-1.9%	-0.1%
4	88.7	-6.7%	-3.1%
5	92.8	-5.6%	1.0%
6	92.7	-3.4%	3.4%
7	89.9	-4.3%	4.1%
8	92.4	-1.4%	4.4%
9	89.0	-0.6%	5.8%
10	88.9	0.4%	6.2%
11	89.7	4.0%	5.4%
12	92.6	3.0%	-0.7%
13	90.9	1.1%	-7.0%
14	89.9	0.5%	-5.8%
15	92.1	-3.2%	0.1%
16	88.9	-1.7%	-6.3%

2700K | Rf: 87.7 | Rg: 96.1
Color Vector Graphic

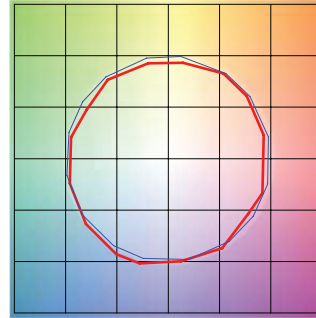

■ Test ■ Reference

		GRAPHIC SHIFTS %	
HUE BIN	Rf	CHROMA	HUE
1	88.0	-4.3%	2.6%
2	91.6	-2.4%	2.0%
3	93.7	-1.4%	1.9%
4	88.9	-5.6%	-3.1%
5	92.3	-5.5%	-0.5%
6	92.9	-3.5%	0.1%
7	84.5	-7.5%	4.6%
8	90.8	-3.0%	4.4%
9	84.5	-1.3%	8.3%
10	83.9	2.0%	9.8%
11	87.2	5.3%	7.1%
12	89.2	5.4%	-2.6%
13	88.7	0.3%	-7.8%
14	86.8	1.7%	-9.3%
15	87.6	-5.4%	-1.3%
16	83.6	-3.3%	-9.5%

3000K | Rf: 88.1 | Rg: 99.7
Color Vector Graphic

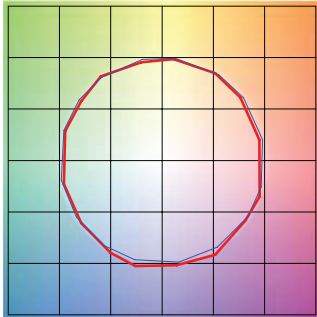

■ Test ■ Reference

		GRAPHIC SHIFTS %	
HUE BIN	Rf	CHROMA	HUE
1	92.5	-3.1%	0.3%
2	93.3	-2.3%	1.9%
3	90.9	-0.8%	3.9%
4	94.3	-1.1%	1.4%
5	92.5	-2.6%	1.5%
6	96.4	1.2%	-0.3%
7	92.6	-2.5%	-0.0%
8	96.9	-1.4%	0.2%
9	92.3	-1.8%	4.3%
10	86.6	-0.7%	7.0%
11	86.5	2.4%	8.2%
12	89.8	5.9%	1.7%
13	93.9	2.6%	-2.7%
14	89.4	5.1%	-5.8%
15	90.1	-0.1%	-4.7%
16	86.5	0.3%	-9.7%

3500K | Rf: 86.1 | Rg: 95.5
Color Vector Graphic

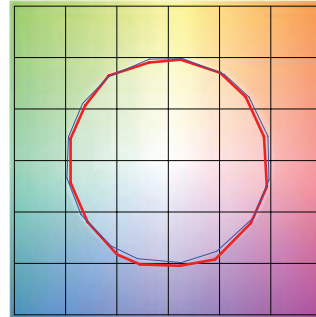

■ Test ■ Reference

		GRAPHIC SHIFTS %	
HUE BIN	Rf	CHROMA	HUE
1	90.8	-3.8%	0.3%
2	92.3	-2.8%	2.1%
3	89.7	-1.0%	4.3%
4	92.6	-1.4%	1.7%
5	91.8	-3.1%	1.3%
6	96.2	0.8%	-0.4%
7	92.9	-3.2%	0.2%
8	94.3	-2.5%	1.5%
9	90.4	-2.5%	5.2%
10	84.3	-1.4%	9.5%
11	83.1	3.5%	9.8%
12	88.2	4.8%	3.4%
13	94.0	2.7%	-2.0%
14	88.7	5.9%	-5.8%
15	88.7	0.7%	-5.9%
16	86.8	-0.7%	-6.7%