

NOVA DOWNLIGHT CENTER FEED

24VDC LED SUSPENSION WITH POWER

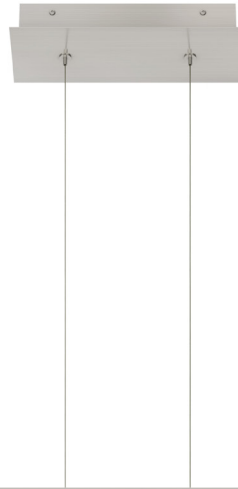

DESCRIPTION

Nova Suspension Downlight with power, center feed is a linear LED fixture that offers spot-free direct light in a clean, contemporary style. Nova is available in various lengths from 36" to 120" (10ft) except Chrome (up to 84") with a 100° white diffused lens or 60° clear frosted lens, optional black or white louver, a variety of finishes, Warm Dim options, and an optional Fast Jack 12V Port (**C1**) for mounting Fast Jack 12V fixtures. Fixture includes a 5 year prorated warranty. For custom designs and quotes, send drawings to design@PureEdgeLighting.com.

INSTALLATION

- Includes a 12" Rectangle Canopy used for sizes 36"-96", or a 24" Rectangle is used for sizes 99"-120"
- Optional Fast Jack 12VAC port (**C1**) for mounting Fast Jack 12V fixtures
- Adjustable 12ft coaxial cables (fixtures exceeding 84" come with additional aircraft cables)

FINISHES



LENSES

- Diffused White 100° lens or Clear Frosted 60° lens, both offered with black or white louvers

LAMPING

- Choose from 9 different color temperatures from 22K - 57K including Warm Dim
- Warm Dim - 2700K to 2000K (**27D**) or 3000K to 2000K (**30D**)
- 50,000 Hour Lamp Life

POWER SUPPLY (INCLUDED IN CANOPY)

- 120V/24V Uni-Drivers
- Optional Fast Jack Power Supply; 12VAC electronic low voltage LED power supply

DIMMER (SOLD SEPARATELY)

- ELV (Electronic Low Voltage)
- Triac (Magnetic)
- 0-10V

APPLICATIONS

Designed for indoor use only. Ideal applications for Residential, Commercial and Hospitality environments.

APPROVALS

- Class 2 Wiring up to 100 watts, Damp Location Suitable, ETL listed, Made in America.

System	Wattage Per Foot	Power Canopy	Nominal Size	Color Temperature	Finish
NSDP	5W	C	120	22K	SN
NSDP Nova Suspension Diffused Lens, with Power NSDWP Nova Suspension Diffused with White Louver, with Power NSDBP Nova Suspension Diffused with Black Louver, with Power NSCWP Nova Suspension Clear Frosted Lens with White Louver, with Power NSCBP Nova Suspension Clear Frosted Lens with Black Louver, with Power	5W 4.4 Watt 7W 7.5 Watt 10W 9.6 Watt	C Center Feed C1 Center Feed with Fast Jack Port	36-120 Order in various increments from 36" to 120"	22K 2200K Amber White 24K 2400K Very Warm White 27K 2700K Incandescent White 27D 2700K Warm Dim (5W only) 30K 3000K Warm White 30D 3000K Warm Dim (5W only) 35K 3500K Neutral White 40K 4000K Cool White 57K 5700K Daylight White	BK Satin Black CH Chrome SA Satin Aluminum SN Satin Nickel WH White

*Maximum shipping length is 84" for chrome
 **See length chart for exact dimensions

PROJECT	FIXTURE TYPE	DATE
---------	--------------	------

Lamp Data: Lamp data for Downlight Channel

DESCRIPTION	NSDP																						
	100 Degree Diffused White Lens without Louver																						
	5w (4.4 watts)						7w (7.3 watts)						10w (9.6 watts)										
WATTS PER FOOT	22K	24K	27K	27D*	30K	30D*	35K	40K	57K	22K	24K	27K	30K	35K	40K	57K	22K	24K	27K	30K	35K	40K	57K
COLOR TEMPERATURE	238	264	290	359	317	359	363	395	420	389	431	475	518	593	645	687	504	559	615	671	769	836	890
LUMENS PER FOOT (lm/ft)	54	60	65	75	72	75	83	89	95	53	59	65	71	81	88	94	52	58	64	70	80	87	93
LUMENS PER WATT (lm/w)	85+	90+	95+	92+	95+	92+	85+	85+	85+	85+	90+	95+	95+	85+	85+	85+	85+	90+	95+	95+	85+	85+	85+
CRI	85+	90+	95+	92+	95+	92+	85+	85+	85+	85+	90+	95+	95+	85+	85+	85+	85+	90+	95+	95+	85+	85+	85+

DESCRIPTION	NSDWP																						
	100 Degree Diffused White Lens with White Louver																						
	5w (4.4 watts)						7w (7.3 watts)						10w (9.6 watts)										
WATTS PER FOOT	22K	24K	27K	27D*	30K	30D*	35K	40K	57K	22K	24K	27K	30K	35K	40K	57K	22K	24K	27K	30K	35K	40K	57K
COLOR TEMPERATURE	166	185	203	252	222	252	254	276	294	272	302	332	363	415	452	481	353	392	430	470	539	586	623
LUMENS PER FOOT (lm/ft)	38	42	46	52	50	52	58	63	67	37	41	45	50	57	62	66	37	41	45	49	56	61	65
LUMENS PER WATT (lm/w)	85+	90+	95+	92+	95+	92+	85+	85+	85+	85+	90+	95+	95+	85+	85+	85+	85+	90+	95+	95+	85+	85+	85+
CRI	85+	90+	95+	92+	95+	92+	85+	85+	85+	85+	90+	95+	95+	85+	85+	85+	85+	90+	95+	95+	85+	85+	85+

DESCRIPTION	NSDBP																						
	100 Degree Diffused White Lens with Black Louver																						
	5w (4.4 watts)						7w (7.3 watts)						10w (9.6 watts)										
WATTS PER FOOT	22K	24K	27K	27D*	30K	30D*	35K	40K	57K	22K	24K	27K	30K	35K	40K	57K	22K	24K	27K	30K	35K	40K	57K
COLOR TEMPERATURE	104	116	127	157	139	157	159	173	184	170	189	208	227	260	283	301	221	245	269	294	337	366	390
LUMENS PER FOOT (lm/ft)	24	26	29	33	31	33	36	39	42	23	26	28	31	36	39	41	23	25	28	31	35	38	41
LUMENS PER WATT (lm/w)	85+	90+	95+	92+	95+	92+	85+	85+	85+	85+	90+	95+	95+	85+	85+	85+	85+	90+	95+	95+	85+	85+	85+
CRI	85+	90+	95+	92+	95+	92+	85+	85+	85+	85+	90+	95+	95+	85+	85+	85+	85+	90+	95+	95+	85+	85+	85+

DESCRIPTION	NSCWP																						
	60 Degree Clear Frosted Lens with White Louver																						
	5w (4.4 watts)						7w (7.3 watts)						10w (9.6 watts)										
WATTS PER FOOT	22K	24K	27K	27D*	30K	30D*	35K	40K	57K	22K	24K	27K	30K	35K	40K	57K	22K	24K	27K	30K	35K	40K	57K
COLOR TEMPERATURE	200	222	244	302	267	302	305	332	353	327	363	399	436	499	543	578	423	470	517	565	647	703	748
LUMENS PER FOOT (lm/ft)	45	50	55	63	60	63	69	75	80	45	50	55	60	68	74	79	44	49	54	59	67	73	78
LUMENS PER WATT (lm/w)	85+	90+	95+	92+	95+	92+	85+	85+	85+	85+	90+	95+	95+	85+	85+	85+	85+	90+	95+	95+	85+	85+	85+
CRI	85+	90+	95+	92+	95+	92+	85+	85+	85+	85+	90+	95+	95+	85+	85+	85+	85+	90+	95+	95+	85+	85+	85+

DESCRIPTION	NSCBP																						
	60 Degree Clear Frosted Lens with Black Louver																						
	5w (4.4 watts)						7w (7.3 watts)						10w (9.6 watts)										
WATTS PER FOOT	22K	24K	27K	27D*	30K	30D*	35K	40K	57K	22K	24K	27K	30K	35K	40K	57K	22K	24K	27K	30K	35K	40K	57K
COLOR TEMPERATURE	125	139	153	189	167	189	191	208	221	204	227	250	273	312	339	361	265	294	323	353	405	440	468
LUMENS PER FOOT (lm/ft)	28	31	34	39	38	39	43	47	50	28	31	34	37	43	46	49	28	31	34	37	42	46	49
LUMENS PER WATT (lm/w)	85+	90+	95+	92+	95+	92+	85+	85+	85+	85+	90+	95+	95+	85+	85+	85+	85+	90+	95+	95+	85+	85+	85+
CRI	85+	90+	95+	92+	95+	92+	85+	85+	85+	85+	90+	95+	95+	85+	85+	85+	85+	90+	95+	95+	85+	85+	85+

*27D, 30D - Warm Dim (4.8 Watts)

5 Watt 100°		7 Watt 100°		10 Watt 100°	
Distance	Foot Candles	Distance	Foot Candles	Distance	Foot Candles
1'	152	1'	251	1'	279
1.5'	100	1.5'	165	1.5'	183
2'	74	2'	121	2'	136
3'	47	3'	79	3'	87
4'	34	4'	57	4'	62
5'	25	5'	43	5'	47
6'	20	6'	34	6'	37
7'	15	7'	27	7'	29
8'	13	8'	23	8'	24

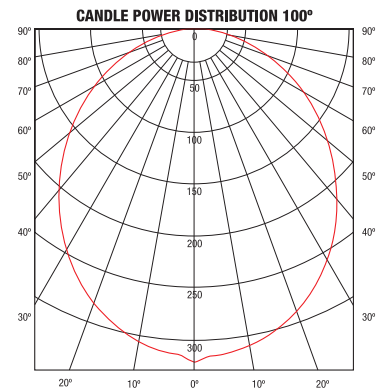
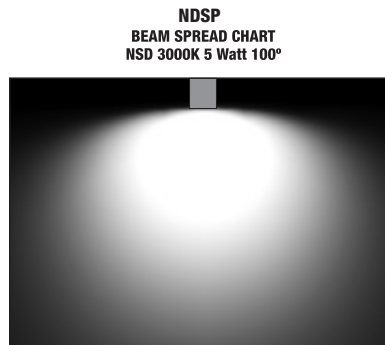
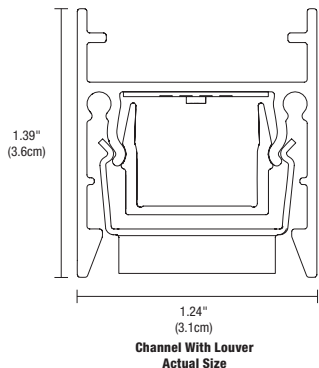
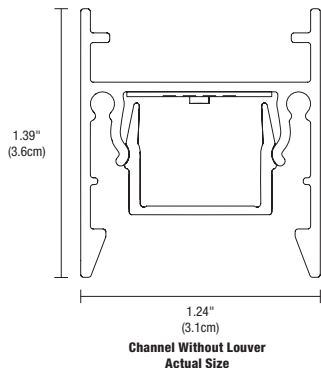

PROJECT	FIXTURE TYPE	DATE
---------	--------------	------

NOVA DOWNLIGHT CENTER FEED

24VDC LED SUSPENSION WITH POWER

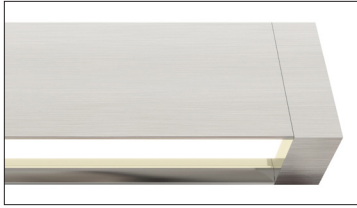

Shown without Louver

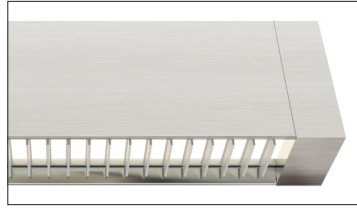

Shown with White Louver

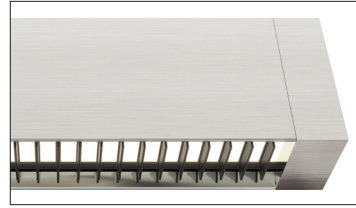

Shown with Black Louver



C1 Canopy, shown with FJ Piston in Satin Nickel (FJ Piston sold separately)

LENGTH CHART: Actual lengths for Nova Suspension Downlight with Power - Center Feed

22K, 24K, 27K, 30K, 35K, 40K, 57K

ORDERING CODE (NOMINAL SIZE)	ACTUAL LENGTH (INCHES)	ACTUAL LENGTH (CHROME)	ORDERING CODE (NOMINAL SIZE)	ACTUAL LENGTH (INCHES)	ACTUAL LENGTH (CHROME)
36	37.3	37.3	80	80.5	80.5
39	39.7	39.7	82	82.9	82.9
41	42.1	42.1	84	85.3	85.3
44	44.5	44.5	87	87.7	88.1
46	46.9	46.9	89	90.1	90.5
48	49.3	49.3	92	92.5	92.9
51	51.7	51.7	94	94.9	95.3
53	54.1	54.1	96	97.3	97.7
56	56.5	56.5	99	99.7	100.1
58	58.9	58.9	101	102.1	102.5
60	61.3	61.3	104	104.5	104.9
63	63.7	63.7	106	106.9	107.3
65	66.1	66.1	108	109.3	109.7
68	68.5	68.5	111	111.7	112.1
70	70.9	70.9	113	114.1	114.5
72	73.3	73.3	116	116.5	116.9
75	75.7	75.7	118	118.9	119.3
77	78.1	78.1	120	121.3	121.7

27D, 30D WARM DIM

ORDERING CODE (NOMINAL SIZE)	ACTUAL LENGTH (INCHES)	ACTUAL LENGTH (CHROME)	ORDERING CODE (NOMINAL SIZE)	ACTUAL LENGTH (INCHES)	ACTUAL LENGTH (CHROME)
36	37.4	37.4	81	82.4	82.4
39	40.4	40.4	84	85.4	85.4
42	43.4	43.4	87	88.4	88.8
45	46.4	46.4	90	91.4	91.8
48	49.4	49.4	93	94.4	94.8
51	52.4	52.4	96	97.4	97.8
54	55.4	55.4	99	100.4	100.8
57	58.4	58.4	102	103.4	103.8
60	61.4	61.4	105	106.4	106.8
63	64.4	64.4	108	109.4	109.8
66	67.4	67.4	111	112.4	112.8
69	70.4	70.4	114	115.4	115.8
72	73.4	73.4	117	118.4	118.8
75	76.4	76.4	120	121.4	121.8
78	79.4	79.4			

PROJECT		FIXTURE TYPE		DATE	
---------	--	--------------	--	------	--

DRAWINGS Canopy and Channel Sizes for the Nova Suspension Downlight with Power - Center Feed

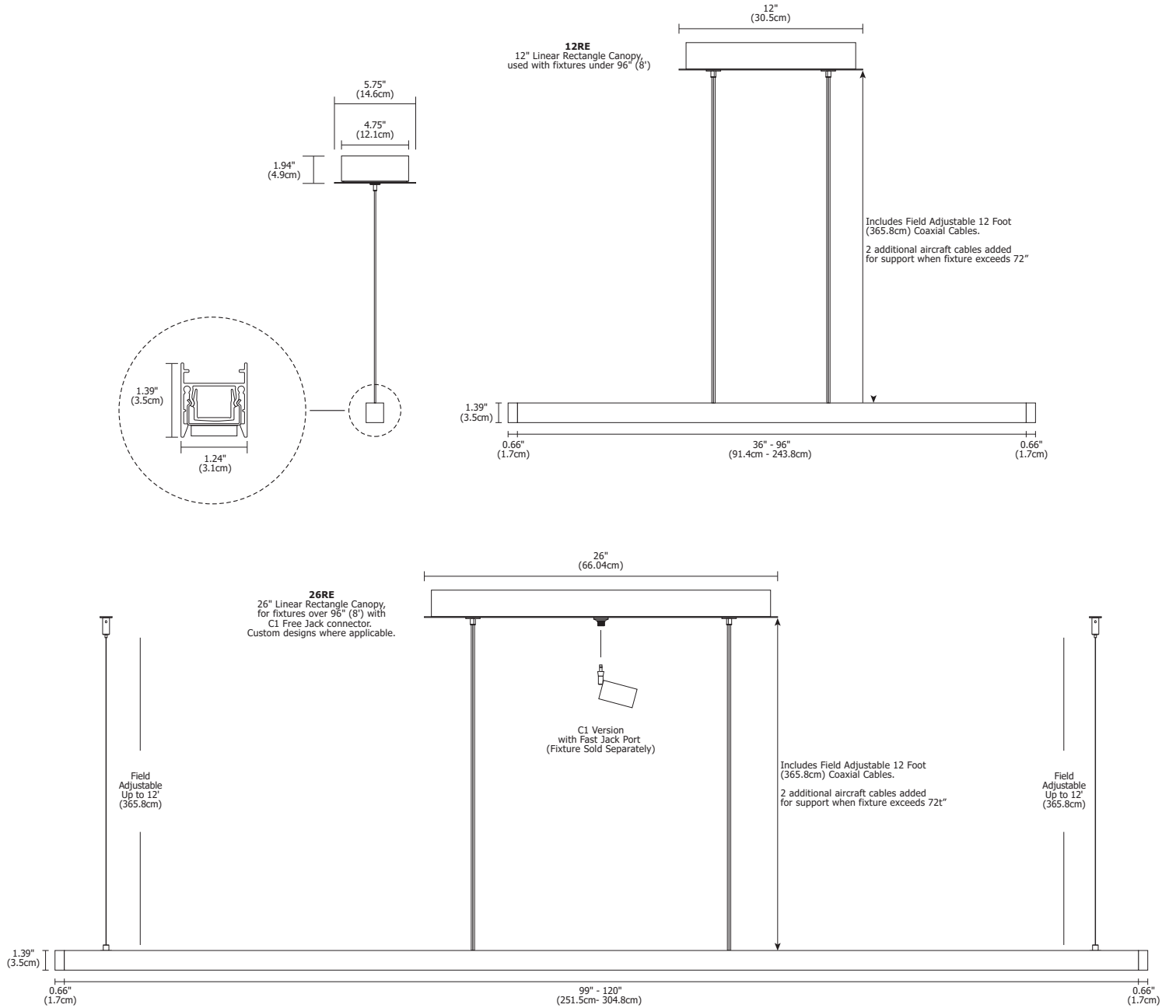

PROJECT	FIXTURE TYPE	DATE
---------	--------------	------

Wiring Diagram: Wiring diagram for Static White with an ELV Dimmer

Application: ELV dimming for Nova Power Suspension, Center Feed Canopy with Fast Jack Port (C1), Static White

Dimming: Dimmable with ELV dimmer: Legrand, Adorne ADTP703TU;
Lutron: Diva DVELV-300P, Skylark, Maestro MAELV-600 and Radio Ra 2

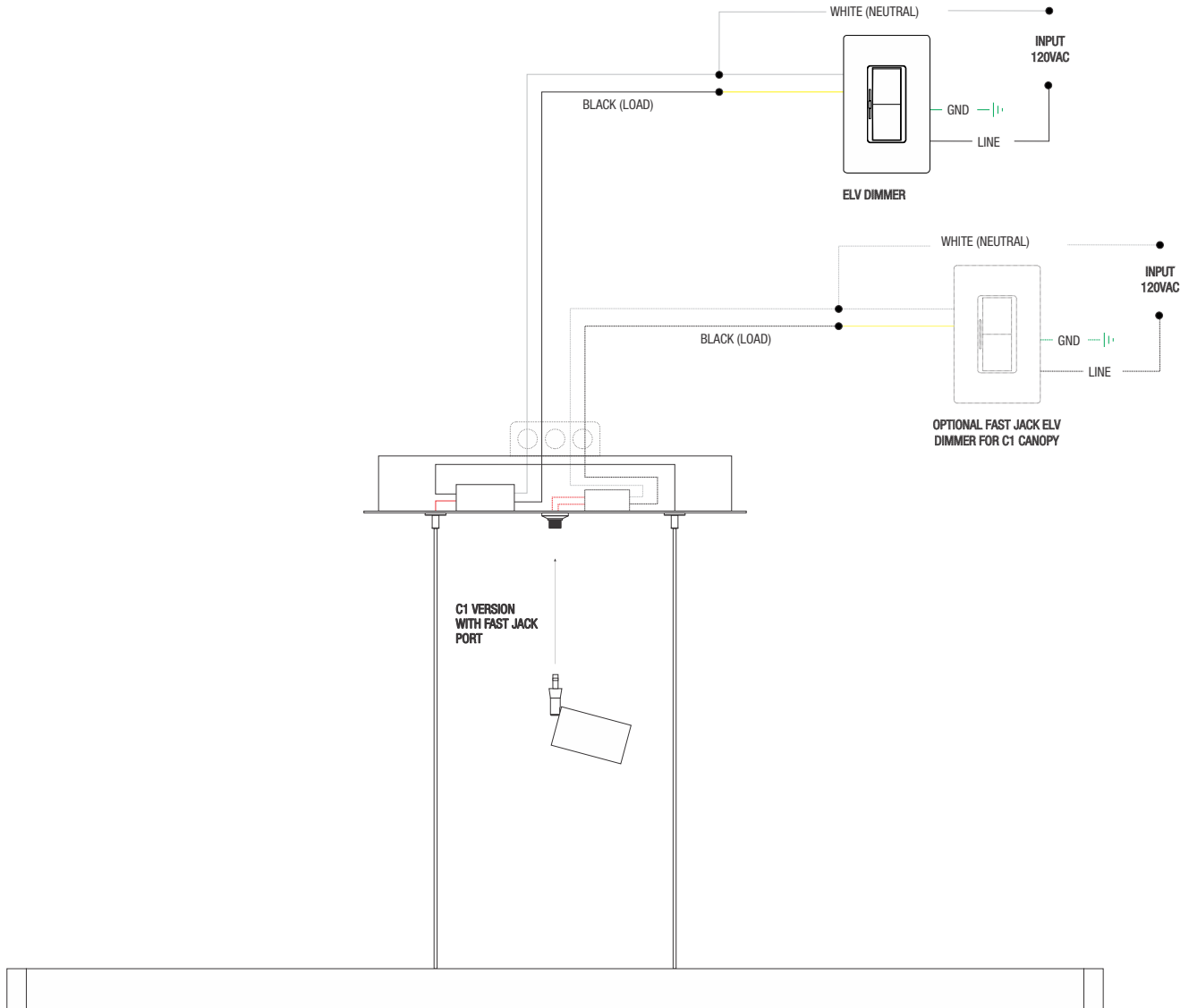

PROJECT	FIXTURE TYPE	DATE

NOVA DOWNLIGHT CENTER FEED

24VDC LED SUSPENSION WITH POWER



FJ-SCO-1-PN
 Fast Jack Scope LED
 9W, 315 lumens 3000K
 (adjustable beam spread
 from 20°-50°)
 Fixture Finishes: SN, PN, BZ, WH



FJ-PST-SP-1-30K-SN
 Fast Jack Piston
 9W, 650 lumens
 SP 15°, NF 25°, FL 35°
 & WF 45° Beam Spreads
 Fixture Finishes: SN, WH



FJ-FOR-SQ-3-PN
FJ-FOR-RD-3-PN
 Fast Jack Form Round or Square
 Fixture Finishes: SN, PN



FJ-FOR-2RD-3-SN
FJ-FOR-2SQ-3-SN
 Fast Jack Form
 Round or Square 2-Head
 Fixture Finishes: SN, PN



FJ-REB-1-PN
 Fast Jack Rebel
 Fixture Finishes: SN, PN, BZ, WH

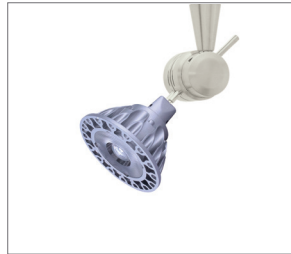

FJ-CHO-1-SN
 Fast Jack Chopper with LED
 Fixture Finishes: SN, PN, BZ



FJ-SPI-3-PN with S1-PN
 Fast Jack Spirit, S1 Shade
 Fixture Finishes: SN, PN, BZ
 S1 Shade Finishes: SN, PN, BZ, BK



FJ-LOW-1-SN with S1-SN
 Fast Jack Low Rider, S1 Shade
 Fixture Finishes: SN, PN, BZ
 S1 Shade Finishes: SN, PN, BZ, BK

FAST JACK FIXTURE & SHADE FINISHES

SN Satin Nickel	PN Polished Nickel	BZ Antique Bronze	WH White	BK Black
------------------------	---------------------------	--------------------------	-----------------	-----------------

PROJECT	FIXTURE TYPE	DATE
---------	--------------	------

12VAC LED MR16

REV 08.19.21

SOL LIGHT WARM DIM

Brand	Ordering Code	Watts	CRI	R9	Beam Angle (Degrees)	Lamp Life (Hours)	CCT Warm Dim	Total Lumens	Lumens Per Watt	Voltage	Certification	Halogen Equivalent
 PureEdge Lighting	MR16-12V-8W-NF-27KWD-SL	8	97+	85	24	30,000	2700K dims to 1800K	390	50	12V	Title 24 Compliant, low flicker <1% CE, UL, NOM	50
	MR16-12V-8W-FL-27KWD-SL	8	97+	85	36	30,000	2700K dims to 1800K	427	55	12V	Title 24 Compliant, low flicker <1% CE, UL, NOM	50
	MR16-12V-8W-NF-30KWD-SL	8	97+	85	24	30,000	3000K dims to 1800K	410	53	12V	Title 24 Compliant, low flicker <1% CE, UL, NOM	50
	MR16-12V-8W-FL-30KWD-SL	8	97+	85	36	30,000	3000K dims to 1800K	450	58	12V	Title 24 Compliant, low flicker <1% CE, UL, NOM	50

SORAA BRILLIANT HIGH LUMEN 2700K COLOR TEMPERATURE

Brand	Ordering Code	Watts	CRI	R9	Beam Angle (Degrees)	Lamp Life (Hours)	CBCP	Total Lumens	Lumens Per Watt	Voltage	Certification	Halogen Equivalent
 SORAA Brilliant HL	SM16-07-10D-827-H1*	8	90	80	10	35,000	8,000	575	77	12V +/- 1.2V	Title 20 certification pending, UL/CUL Class 2 and non-Class 2, FCC Title 47 Part 15B, RoHS, CE	75
	SM16-07-25D-827-H1	8	90	80	25	35,000	3,710	600	80	12V +/- 1.2V	Title 20 certification pending, UL/CUL Class 2 and non-Class 2, FCC Title 47 Part 15B, RoHS, CE	75
	SM16-07-36D-827-H1	8	90	80	36	35,000	1,550	600	80	12V +/- 1.2V	Title 20 certification pending, UL/CUL Class 2 and non-Class 2, FCC Title 47 Part 15B, RoHS, CE	75

*Use with Snap Lens

SORAA VIVID 2700K COLOR TEMPERATURE INDOOR/OUTDOOR

Brand	Ordering Code	Watts	CRI	R9	Beam Angle (Degrees)	Lamp Life (Hours)	CCT Warm Dim	Total Lumens	Lumens Per Watt	Voltage	Certification	Halogen Equivalent
 SORAA Vivid	SM16-07-10d-927-03*	8	95	95	10	35,000	5,710	390	52	12V +/- 1.2V	JA8-2016-E, UL/CUL Class 2 and non-Class 2, FCC Title 47 Part 15B, RoHS, CE	50
	SM16-07-25D-927-03	8	95	95	25	35,000	2,260	410	55	12V +/- 1.2V	JA8-2016-E, UL/CUL Class 2 and non-Class 2, FCC Title 47 Part 15B, RoHS, CE	50
	SM16-07-36D-927-03	8	95	95	36	35,000	1,070	410	55	12V +/- 1.2V	JA8-2016-E, UL/CUL Class 2 and non-Class 2, FCC Title 47 Part 15B, RoHS, CE	50

*Use with Snap Lens

SORAA HEALTHY

Brand	Ordering Code	Watts	CRI	R9	Beam Angle (Degrees)	Lamp Life (Hours)	CCT Warm Dim	Total Lumens	Lumens Per Watt	Voltage	Certification	Halogen Equivalent
 SORAA Vivid	SH-MR16-07-36D-27-01-X2	8	80	90	36	25,000	1,020	400	53	12V +/- 1.2V	UL/CUL, FCC Title 47 Part 15B, RoHS	50

SORAA BRILLIANT HIGH LUMEN 3000K COLOR TEMPERATURE

Brand	Ordering Code	Watts	CRI	R9	Beam Angle (Degrees)	Lamp Life (Hours)	CBCP	Total Lumens	Lumens Per Watt	Voltage	Certification	Halogen Equivalent
 SORAA Brilliant HL	SM16-07-10D-830-H1*	8	90	80	10	35,000	8,400	600	80	12V +/- 1.2V	Title 20 certification pending, UL/CUL Class 2 and non-Class 2, FCC Title 47 Part 15B, RoHS, CE	75
	SM16-07-25D-830-H1	8	90	80	25	35,000	3,300	630	84	12V +/- 1.2V	Title 20 certification pending, UL/CUL Class 2 and non-Class 2, FCC Title 47 Part 15B, RoHS, CE	75
	SM16-07-36D-830-H1	8	90	80	36	35,000	1,650	630	84	12V +/- 1.2V	Title 20 certification pending, UL/CUL Class 2 and non-Class 2, FCC Title 47 Part 15B, RoHS, CE	75

*Use with Snap Lens

PROJECT		FIXTURE TYPE		DATE	
---------	--	--------------	--	------	--

12VAC LED MR16

REV 08.19.21

SORAA VIVID 3000K COLOR TEMPERATURE MR16 INDOOR/OUTDOOR

Brand	Ordering Code	Watts	CRI	R9	Beam Angle (Degrees)	Lamp Life (Hours)	CCT Warm Dim	Total Lumens	Lumens Per Watt	Voltage	Certification	Halogen Equivalent
 SORAA Vivid	SM16-07-10D-930-03*	8	95	95	10	35,000	6,000	410	55	12V +/- 1.2V	JA8-2016-E, UL/CUL Class 2 and non-Class 2, FCC Title 47 Part 15B, RoHS, CE	50
	SM16-07-25D-930-03	8	95	95	25	35,000	2,400	435	58	12V +/- 1.2V	JA8-2016-E, UL/CUL Class 2 and non-Class 2, FCC Title 47 Part 15B, RoHS, CE	50
	SM16-07-36D-930-03	8	95	95	36	35,000	1,130	435	58	12V +/- 1.2V	JA8-2016-E, UL/CUL Class 2 and non-Class 2, FCC Title 47 Part 15B, RoHS, CE	50

*Use with Snap Lens

SORAA VIVID 4000K COLOR TEMPERATURE MR16 INDOOR/OUTDOOR

Brand	Ordering Code	Watts	CRI	R9	Beam Angle (Degrees)	Lamp Life (Hours)	CBCP	Total Lumens	Lumens Per Watt	Voltage	Certification	Halogen Equivalent
 SORAA Vivid	SM16-07-10D-940-03*	8	95	95	10	35,000	6,290	430	57	12V +/- 1.2V	JA8-2016-E, UL/CUL Class 2 and non-Class 2, FCC Title 47 Part 15B, RoHS, CE	50
	SM16-07-25D-940-03	8	95	95	25	35,000	2,510	455	61	12V +/- 1.2V	JA8-2016-E, UL/CUL Class 2 and non-Class 2, FCC Title 47 Part 15B, RoHS, CE	50
	SM16-07-36D-940-03	8	95	95	36	35,000	1,190	455	61	12V +/- 1.2V	JA8-2016-E, UL/CUL Class 2 and non-Class 2, FCC Title 47 Part 15B, RoHS, CE	50

*Use with Snap Lens

SATCO 3500K COLOR TEMPERATURE MR16 INDOOR/OUTDOOR

Brand	Ordering Code	Watts	CRI	R9	Beam Angle (Degrees)	Lamp Life (Hours)	CBCP	Total Lumens	Lumens Per Watt	Voltage	Certification	Halogen Equivalent
 SATCO 3500K	S8637	8	90+	N/A	15	25,000	6,290	430	61	12	UL/CUL, FCC Title 47 Part 15B, RoHS, Lawful for sale in California	75
	S8642	8	90+	N/A	40	25,000	2,510	455	61	12	UL/CUL, FCC Title 47 Part 15B, RoHS, Lawful for sale in California	75

8MR16/LED/40/35K/90CRI/12V 8 watt; LED MR16; 3500K; 40° beam spread; GU5.3 base; 12 volts. Features: Silver back MR16 reflector. Direct replacements for 75 watt Halogen lamps - uses only 8 watts. Dimmable. No UV or IR radiation. Approved for enclosed fixtures.

PROJECT		FIXTURE TYPE		DATE	
---------	--	--------------	--	------	--

SORAA VIVID MR16 36° FL
3000K | Rf: 90.4 | Rg: 99.5
Color Vector Graphic

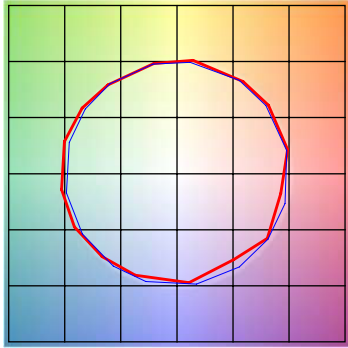

■ Test ■ Reference

HUE BIN	Rf	GRAPHIC SHIFTS %	
		CHROMA	HUE
1	94.4	1.0%	0.8%
2	94.6	2.1%	-1.1%
3	91.9	1.1%	-3.3%
4	91.9	2.1%	-2.1%
5	93.9	0.4%	-0.9%
6	95.2	0%	1.9%
7	93.4	2.7%	-0.7%
8	92.7	4.2%	0.1%
9	90.5	3.6%	-3.9%
10	84.3	2.3%	-9.2%
11	81.3	2.3%	-12.7%
12	81.3	-3.6%	-10.3%
13	90.5	-2.5%	-6.2%
14	88.5	-8.2%	-0.4%
15	96.2	-1.0%	0.3%
16	86.6	-5.4%	8.2%

SOL-LIGHT WARM DIM MR16 36° FL
3000K | Rf: 94.2 | Rg: 101.2
Color Vector Graphic

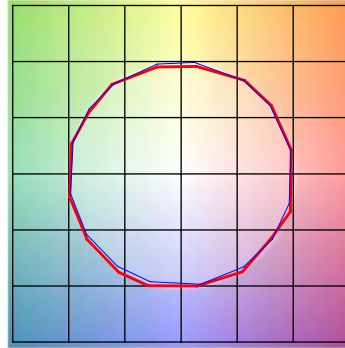

■ Test ■ Reference

HUE BIN	Rf	GRAPHIC SHIFTS %	
		CHROMA	HUE
1	96.0	0.3%	0.7%
2	96.8	0.9%	-0.8%
3	95.6	0.5%	-0.8%
4	93.1	-3.2%	-2.7%
5	95.7	-2.4%	0.4%
6	96.8	0.4%	1.6%
7	92.4	-1.4%	3.5%
8	96.8	1.2%	1.2%
9	94.0	1.4%	3.1%
10	92.6	2.1%	3.9%
11	92.2	3.7%	3.9%
12	92.4	3.9%	-0.9%
13	94.7	0.9%	-3.3%
14	93.4	3.0%	-3.2%
15	93.6	-1.1%	0.9%
16	90.2	2.4%	-6.7%

SORAA VIVID MR16 25° NFL
3000K | Rf: 94.0 | Rg: 101.0
Color Vector Graphic

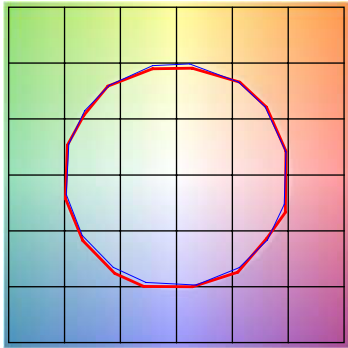

■ Test ■ Reference

HUE BIN	Rf	GRAPHIC SHIFTS %	
		CHROMA	HUE
1	95.9	0.3%	0.8%
2	96.8	0.8%	-0.9%
3	95.5	0.4%	-0.9%
4	92.7	-3.4%	-2.9%
5	95.6	-2.7%	0.4%
6	96.8	0.1%	1.6%
7	92.2	-1.6%	3.7%
8	96.6	1.1%	1.5%
9	93.7	1.4%	3.3%
10	92.4	2.2%	4.1%
11	92.2	3.8%	3.8%
12	92.4	3.9%	-1.1%
13	94.4	0.8%	-3.6%
14	93.3	2.8%	-3.4%
15	93.4	-1.4%	0.9%
16	90.3	2.2%	-6.7%

SOL-LIGHT WARM DIM MR16 24° NFL
3000K | Rf: 94.2 | Rg: 101.2
Color Vector Graphic

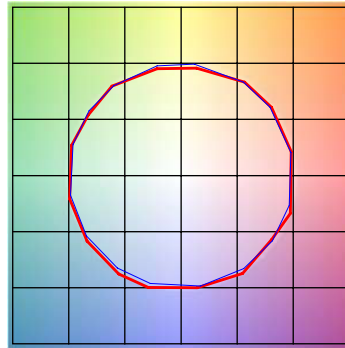

■ Test ■ Reference

HUE BIN	Rf	GRAPHIC SHIFTS %	
		CHROMA	HUE
1	95.9	0.3%	0.8%
2	96.8	0.8%	-0.9%
3	95.5	0.4%	-0.9%
4	92.7	-3.4%	-2.9%
5	95.6	-2.7%	0.4%
6	96.8	0.1%	1.6%
7	92.2	-1.6%	3.7%
8	96.6	1.1%	1.5%
9	93.7	1.4%	3.3%
10	92.4	2.2%	4.1%
11	92.2	3.8%	3.8%
12	92.4	3.9%	-1.1%
13	94.4	0.8%	-3.6%
14	93.3	2.8%	-3.4%
15	93.4	-1.4%	0.9%
16	90.3	2.2%	-6.7%

PROJECT	FIXTURE TYPE	DATE
---------	--------------	------

TM-30-15 DATA: The data below is for SS5C, SS7C, and SS10C bare LED Soft Strips. Consistent color temperatures throughout a single strip and among multiple strips is possible through a 3 phase binning process in which each order is inspected with a color meter to ensure uniformity.

2200K | Rf: 83.9 | Rg: 94.9
Color Vector Graphic

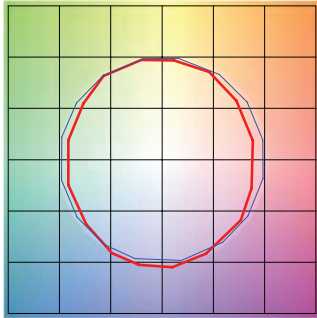

■ Test ■ Reference

HUE BIN	Rf	GRAPHIC SHIFTS %	
		CHROMA	HUE
1	78.8	-9.5%	1.3%
2	80.7	-7.8%	6.7%
3	78.2	-3.3%	9.4%
4	89.7	-2.8%	3.6%
5	93.2	-0.8%	2.6%
6	93.0	-0.6%	-0.7%
7	87.7	-5.9%	-3.5%
8	89.2	-6.8%	1.9%
9	83.4	-5.6%	6.0%
10	79.3	-3.7%	10.8%
11	81.4	2.9%	11.1%
12	84.9	5.3%	4.9%
13	88.1	4.9%	-10.1%
14	68.1	0.1%	-19.5%
15	86.0	-3.3%	-7.3%
16	76.4	-8.9%	-11.7%

2400K | Rf: 91.2 | Rg: 96.8
Color Vector Graphic

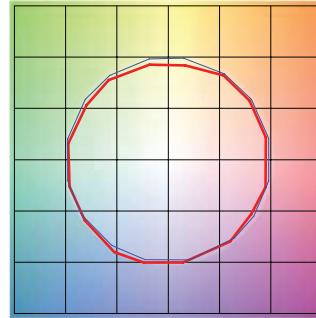

■ Test ■ Reference

HUE BIN	Rf	GRAPHIC SHIFTS %	
		CHROMA	HUE
1	92.0	-2.4%	1.5%
2	94.7	-2.1%	0.0%
3	95.4	-1.9%	-0.1%
4	88.7	-6.7%	-3.1%
5	92.8	-5.6%	1.0%
6	92.7	-3.4%	3.4%
7	89.9	-4.3%	4.1%
8	92.4	-1.4%	4.4%
9	89.0	-0.6%	5.8%
10	88.9	0.4%	6.2%
11	89.7	4.0%	5.4%
12	92.6	3.0%	-0.7%
13	90.9	1.1%	-7.0%
14	89.9	0.5%	-5.8%
15	92.1	-3.2%	0.1%
16	88.9	-1.7%	-6.3%

2700K | Rf: 87.7 | Rg: 96.1
Color Vector Graphic

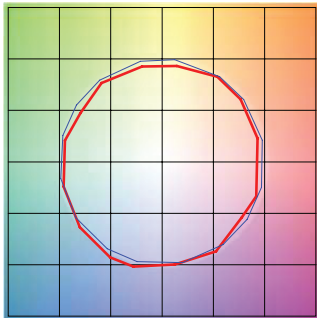

■ Test ■ Reference

HUE BIN	Rf	GRAPHIC SHIFTS %	
		CHROMA	HUE
1	88.0	-4.3%	2.6%
2	91.6	-2.4%	2.0%
3	93.7	-1.4%	1.9%
4	88.9	-5.6%	-3.1%
5	92.3	-5.5%	-0.5%
6	92.9	-3.5%	0.1%
7	84.5	-7.5%	4.6%
8	90.8	-3.0%	4.4%
9	84.5	-1.3%	8.3%
10	83.9	2.0%	9.8%
11	87.2	5.3%	7.1%
12	89.2	5.4%	-2.6%
13	88.7	0.3%	-7.8%
14	86.8	1.7%	-9.3%
15	87.6	-5.4%	-1.3%
16	83.6	-3.3%	-9.5%

3000K | Rf: 88.1 | Rg: 99.7
Color Vector Graphic

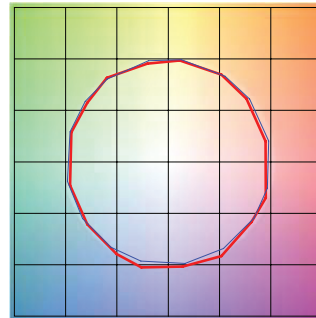

■ Test ■ Reference

HUE BIN	Rf	GRAPHIC SHIFTS %	
		CHROMA	HUE
1	92.5	-3.1%	0.3%
2	93.3	-2.3%	1.9%
3	90.9	-0.8%	3.9%
4	94.3	-1.1%	1.4%
5	92.5	-2.6%	1.5%
6	96.4	1.2%	-0.3%
7	92.6	-2.5%	-0.0%
8	96.9	-1.4%	0.2%
9	92.3	-1.8%	4.3%
10	86.6	-0.7%	7.0%
11	86.5	2.4%	8.2%
12	89.8	5.9%	1.7%
13	93.9	2.6%	-2.7%
14	89.4	5.1%	-5.8%
15	90.1	-0.1%	-4.7%
16	86.5	0.3%	-9.7%

3500K | Rf: 86.1 | Rg: 95.5
Color Vector Graphic

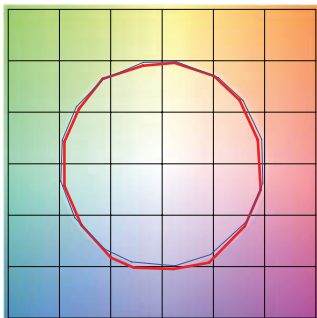

■ Test ■ Reference

HUE BIN	Rf	GRAPHIC SHIFTS %	
		CHROMA	HUE
1	90.8	-3.8%	0.3%
2	92.3	-2.8%	2.1%
3	89.7	-1.0%	4.3%
4	92.6	-1.4%	1.7%
5	91.8	-3.1%	1.3%
6	96.2	0.8%	-0.4%
7	92.9	-3.2%	0.2%
8	94.3	-2.5%	1.5%
9	90.4	-2.5%	5.2%
10	84.3	-1.4%	9.5%
11	83.1	3.5%	9.8%
12	88.2	4.8%	3.4%
13	94.0	2.7%	-2.0%
14	88.7	5.9%	-5.8%
15	88.7	0.7%	-5.9%
16	86.8	-0.7%	-6.7%

4000K | Rf: 87.6 | Rg: 96.8
Color Vector Graphic

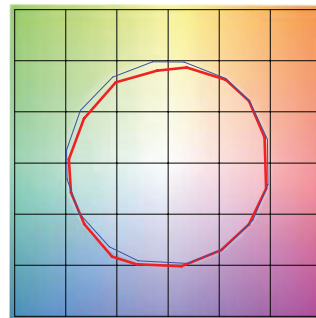

■ Test ■ Reference

HUE BIN	Rf	GRAPHIC SHIFTS %	
		CHROMA	HUE
1	88.9	-2.4%	2.5%
2	93.3	-0.4%	0.8%
3	94.8	-1.0%	-0.6%
4	87.9	-4.9%	-3.6%
5	85.3	-9.4%	-2.6%
6	90.2	-6.0%	0.2%
7	85.3	-7.6%	4.6%
8	83.7	-4.1%	8.2%
9	79.5	-1.1%	13.8%
10	78.6	1.5%	12.1%
11	83.5	6.4%	7.8%
12	90.9	3.6%	-1.1%
13	88.3	1.7%	-6.3%
14	91.9	-0.4%	-2.2%
15	84.5	-0.9%	-5.5%
16	84.7	-1.1%	-4.4%

PROJECT	FIXTURE TYPE	DATE
---------	--------------	------

TM30 DATA

24VDC LED SUSPENSION WITH POWER

TM-30-15 DATA: The data below is for SS5C, SS7C, and SS10C bare LED Soft Strips. Consistent color temperatures throughout a single strip and among multiple strips is possible through a 3 phase binning process in which each order is inspected with a color meter to ensure uniformity.

5700K | Rf: 80.3 | Rg: 91.5

Color Vector Graphic

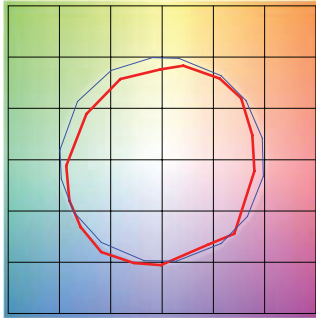

■ Test ■ Reference

HUE BIN	Rf	GRAPHIC SHIFTS %	
		CHROMA	HUE
1	75.4	-8.9%	4.7%
2	87.5	-2.6%	4.6%
3	90.7	-3.0%	-0.5%
4	83.2	-6.0%	-5.7%
5	76.2	-12.9%	-5.3%
6	81.4	-11.9%	-2.6%
7	74.8	-14.0%	5.1%
8	69.0	-9.0%	14.1%
9	72.6	-3.6%	22.2%
10	71.4	2.7%	16.1%
11	81.3	7.9%	5.3%
12	83.6	4.1%	-9.4%
13	78.4	0.7%	-15.3%
14	77.7	-6.2%	-11.0%
15	68.8	-1.3%	-21.2%
16	80.8	-9.6%	3.3%

2700D | Rf: 89.5 | Rg: 100.8

Color Vector Graphic

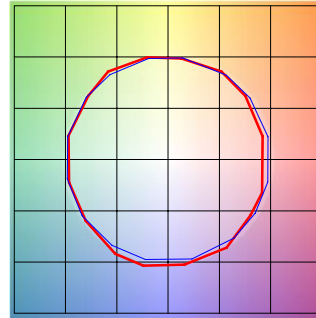

■ Test ■ Reference

HUE BIN	Rf	GRAPHIC SHIFTS %	
		CHROMA	HUE
1	88.8	-5.1%	1.4%
2	89.8	-2.7%	4.1%
3	87.2	0.3%	5.9%
4	92.3	-0.9%	1.0%
5	93.3	1.5%	1.7%
6	92.4	3.6%	-0.2%
7	92.2	-0.9%	-2.4%
8	96.7	-0.4%	-1.1%
9	92.3	-1.2%	3.7%
10	88.9	-0.0%	6.1%
11	86.4	5.1%	7.4%
12	88.2	6.3%	-0.9%
13	87.2	3.8%	-8.1%
14	84.2	3.8%	-11.0%
15	89.8	-2.6%	-4.3%
16	82.7	-3.4%	-11.1%

3000D | Rf: 89.8 | Rg: 101.4

Color Vector Graphic

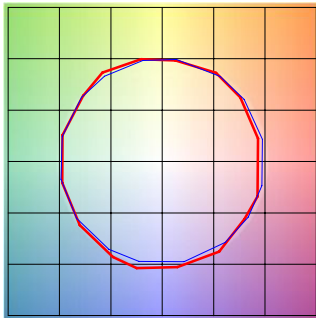

■ Test ■ Reference

HUE BIN	Rf	GRAPHIC SHIFTS %	
		CHROMA	HUE
1	90.2	-4.2%	1.5%
2	90.9	-2.0%	3.7%
3	87.9	0.8%	5.5%
4	92.1	-0.9%	0.6%
5	93.0	1.5%	1.6%
6	92.2	3.9%	-0.2%
7	92.1	-0.3%	-2.0%
8	96.7	0.0%	-1.2%
9	92.5	-0.6%	3.7%
10	88.3	1.1%	7.0%
11	87.2	4.1%	7.4%
12	87.2	6.7%	-1.0%
13	88.2	3.8%	-7.2%
14	85.3	4.3%	-9.9%
15	90.9	-2.2%	-3.6%
16	83.4	-2.2%	-11.2%

PROJECT	FIXTURE TYPE	DATE
---------	--------------	------