

# TRULINE 1A STATIC WHITE

## 24VDC, 5/8" DRYWALL PLASTER-IN LED SYSTEM

DESIGNED BY GREGORY KAY | ASSEMBLED IN AMERICA

REV 10.20.23



### Let The Drywall Be Your Canvas

#### DESCRIPTION

PureEdge pioneered the TruLine 1A Plaster-in 24VDC LED system that Recesses within 5/8" drywall, without any joist modification. Redefining the relationship between Lighting and Interior Design, this Innovative and highly Efficient system blends seamlessly into the drywall, becoming part of the Architecture. The slim extrusions, LED strips, and lenses are field-cutable and ordered in 1' increments (up to 40' before re-feeding). Multiple runs of channel mount flawlessly together providing smooth and Glare-free general illumination using Designer-grade Color Rendering LEDs (95+ CRI). With the ability to run in vertical, horizontal, and diagonal directions, the compositions are truly endless. The TruLine 1A Plaster-in LED System is offered in multiple wattage and color temperatures ranging from **2400K** through **4000K**. Click here for all [Other Color Temperatures](#). Includes a 5-year pro-rated warranty. For custom designs and quotes, send drawings to [design@PureEdgeLighting.com](mailto:design@PureEdgeLighting.com).

#### DESIGN NOTE

TruLine 1A can be installed on a single surface, join runs on multiple planes from wall to ceiling, or from one wall to an adjacent wall. Use TruLine 1A Build-It-Yourself (BIY) with pre-formed components to create desired configurations, including Mitered Picture Frame and Outside or Inside Corners for Room Wrapping installations. Create square or rectangular compositions with TruQuad 1A.

#### ORDERING & INSTALLATION

TruLine 1A can be secured to studs spaced 13"-24" apart or between studs with provided mounting straps. Order in 1' increments, field-cutable to any length.

#### MAXIMUM LENGTHS BEFORE RE-FEEDING:

- 2WDC, 2.5 watts per foot - 40'
- 5WDC, 4.4 watts per foot - 20'
- 7WDC, 7.5 watts per foot - 12'

#### LAMP

- Offered in multiple Static White Color Temperatures: 2400K, 2700K, 3000K, 3500K & 4000K
- Lumen Performance: 570lm/ft at 3000K 7 watts per foot
- Designer Grade High CRI 95+ LEDs
- Average life: 50,000 hours
- For additional color temperatures refer to other specifications

#### REMOTE POWER SUPPLIES\*, DIMMERS & CONTROLS (SOLD SEPARATELY)

24VDC, Class 2 wiring

- [Pure Smart™ Wiz Pro Power Supplies & Controls](#)
- [UNI Driver: Universal Dimming \(TRIAC, ELV, 0-10V\)](#)
- [Lutron](#) Hi-Lume/Ecosystem

\*In-Wall Mounting and drop ceiling Kits available for select power supplies

#### APPLICATIONS

Designed for any Indoor space with drywall, including Damp locations. Ideal applications in Residential, Commercial, Retail, and Hospitality environments.

#### COMPLIANCE

ETL Listed, Class 2, \*Title 24 JA8 listed for 2700K CCT and above when used with PureEdge remote Universal power supplies Damp Location, Made in USA.

For quick & easy reference, plus the most up-to-date pricing, use our [Truline 1A Configurator](#)

PureEdge is the Original Designer of 5/8" Drywall Lighting Products with the most Experience in the industry.

System	Watts Per Foot	Length in Feet	Color Temperature
<b>TL1A</b>	<b>5WDC</b>	<b>20FT</b>	<b>ST27K</b>
TL1A TruLine 1A	<b>2WDC</b> 2.5 Watts (40ft Max) <b>5WDC</b> 5 Watts (20ft Max) <b>7WDC</b> 7.5 Watts (12ft Max)	<b>1-40FT</b> <b>1-20FT</b> <b>1-12FT</b>	<b>ST24K</b> 2400K Very Warm White <b>ST27K</b> 2700K Incandescent White <b>ST30K</b> 3000K Warm White <b>ST35K</b> 3500K Neutral White <b>ST40K</b> 4000K Cool White

PROJECT		FIXTURE TYPE		DATE	
---------	--	--------------	--	------	--

# TRULINE 1A STATIC WHITE

## 24VDC, 5/8" DRYWALL PLASTER-IN LED SYSTEM

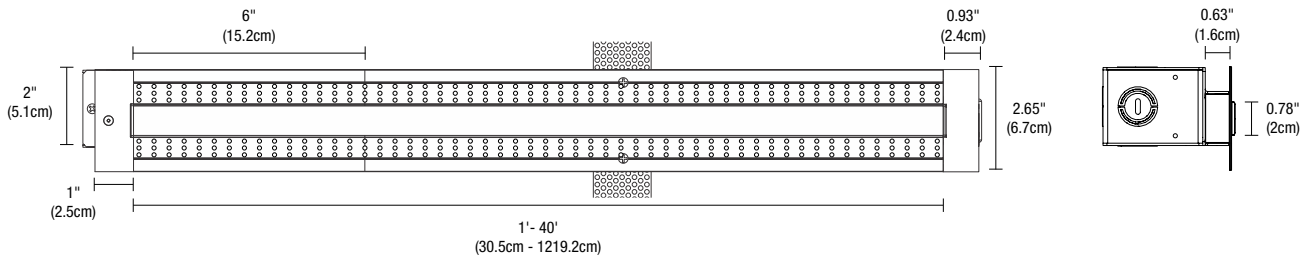

### INCLUDED COMPONENTS

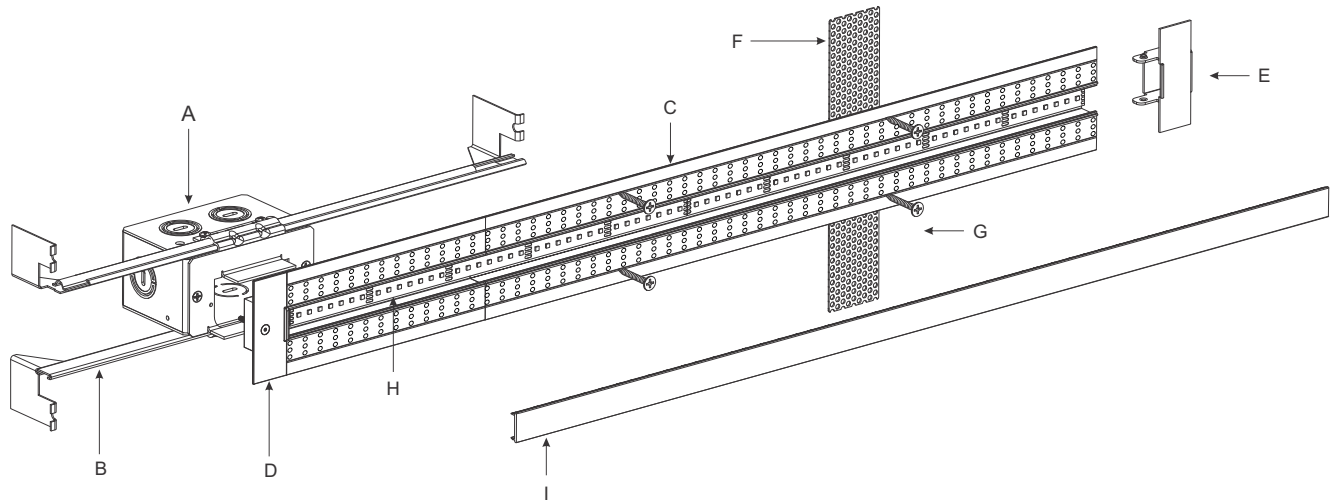

#### A. JUNCTION BOX

Mounts behind drywall with Adjustable Mounting Bars. Low Voltage 24VDC wires from Remote Power Supply connect to LED wires inside box. Junction Box opening is covered by the channel, and required at the beginning of each run.

#### B. ADJUSTABLE MOUNTING BARS

Provide flexibility for mounting in a variety of spaces and orientations. May be secured to studs that are spaced 13"-24" apart.

#### C. TRULINE 1A CHANNEL

5/8" deep extrusion house for a single row of LED Strip.

#### D. POWER END CAP

Provides a finished look and prevents light leak at the feed-end of a run where LED Strip enters channel.

#### E. TAKE-UP BOX

Prevents dark spots at end of a run by tucking excess LED Strip safely behind the wall.

#### F. MOUNTING STRAP

Secures channel to drywall when wall stud is unavailable.

#### G. DRYWALL SCREW

Secures channel to drywall and stud.

#### H. LED STRIP

Your selection of LED Strip CCT.

#### I. LENS

0.8" wide diffused white lens projects a clean line of light without pixelation.

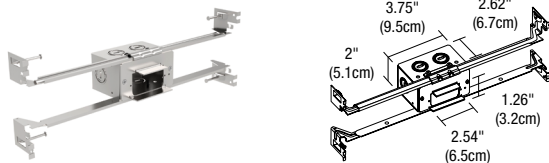

#### JUNCTION BOX ROUGH-IN COMPONENT

One Junction Box is included with TruLine 1A. Order additional Junction Box separately to rough-in electrical wiring before drywall installation. Quick shipment available.

System	Size	Component
<b>TL1A</b>	<b>1RE</b>	<b>JBOX</b>
TL1A TruLine 1A	1RE 1" Rectangle	JBOX Junction Box

PROJECT	FIXTURE TYPE	DATE
---------	--------------	------

# TRULINE 1A STATIC WHITE

## 24VDC, 5/8" DRYWALL PLASTER-IN LED SYSTEM

REV 10.20.23

### DELIVERED LUMENS

STATIC WHITE															
WATTS PER FOOT	2.5W					4.4W					7.5W				
COLOR TEMPERATURE	24K	27K	30K	35K	40K	24K	27K	30K	35K	40K	24K	27K	30K	35K	40K
LUMENS PER FOOT (lm/ft)	190	192	200	229	241	350	354	369	423	446	541	547	570	654	689
LUMENS PER WATT (lm/w)	76	77	80	92	97	80	80	84	96	101	74	75	78	90	94
CRI	92+	92+	92+	92+	92+	92+	92+	92+	92+	92+	92+	92+	92+	92+	92+

**LENGTH LOAD CHARTS:** To determine the necessary wire gauge use our [Voltage Drop Calculator](#).

2.5 WATTS PER FOOT			
LENGTH IN FEET	WATTS	LENGTH IN FEET	WATTS
1	3	21	51
2	5	22	54
3	8	23	56
4	10	24	58
5	13	25	61
6	15	26	63
7	17	27	66
8	20	28	68
9	22	29	70
10	24	30	72
11	27	31	75
12	29	32	77
13	32	33	79
14	34	34	81
15	37	35	83
16	39	36	85
17	41	37	87
18	44	38	89
19	46	39	91
20	48	40	93

4.4 WATTS PER FOOT	
LENGTH IN FEET	WATTS
1	5
2	10
3	16
4	20
5	24
6	30
7	34
8	40
9	44
10	48
11	54
12	58
13	64
14	68
15	72
16	78
17	82
18	88
19	92
20	96

7.5 WATTS PER FOOT	
LENGTH IN FEET	WATTS
1	7.5
2	15
3	22.5
4	30
5	37.5
6	45
7	52.5
8	60
9	67.5
10	75
11	82.5
12	90

PROJECT		FIXTURE TYPE		DATE	
---------	--	--------------	--	------	--

# TM30 DATA

24VDC, 5/8" DRYWALL PLASTER-IN LED SYSTEM

**TM-30-15 DATA:** The data below is for bare LED Static White Strip. Consistent color temperatures throughout a single strip and among multiple strips is possible through a 3 phase binning process in which each order is inspected with a color meter to ensure uniformity.

**2400K** | Rf: 84.5 | Rg: 94.4

Color Vector Graphic

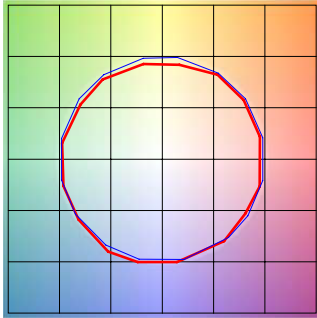

■ Test ■ Reference

HUE BIN	Rf	GRAPHIC SHIFTS %	
		CHROMA	HUE
1	92	-2.4%	1.5%
2	94.7	-2.1%	-0.0%
3	95.4	-1.9%	-0.1%
4	88.7	-6.7%	-3.1%
5	92.8	-5.6%	1.0%
6	92.7	-3.4%	3.4%
7	89.9	-4.3%	4.1%
8	92.4	-1.4%	4.4%
9	89	-0.6%	5.8%
10	88.9	0.4%	6.2%
11	89.7	4.0%	5.4%
12	92.6	3.0%	-0.7%
13	90.9	1.1%	-7.0%
14	89.9	0.5%	-5.8%
15	92.1	-3.2%	0.1%
16	88.9	-1.7%	-6.3%

**2700K** | Rf: 87.7 | Rg: 96.1

Color Vector Graphic

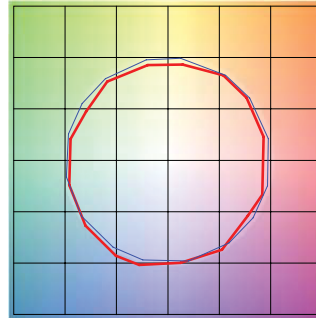

■ Test ■ Reference

HUE BIN	Rf	GRAPHIC SHIFTS %	
		CHROMA	HUE
1	88.0	-4.3%	2.6%
2	91.6	-2.4%	2.0%
3	93.7	-1.4%	1.9%
4	88.9	-5.6%	-3.1%
5	92.3	-5.5%	-0.5%
6	92.9	-3.5%	0.1%
7	84.5	-7.5%	4.6%
8	90.8	-3.0%	4.4%
9	84.5	-1.3%	8.3%
10	83.9	2.0%	9.8%
11	87.2	5.3%	7.1%
12	89.2	5.4%	-2.6%
13	88.7	0.3%	-7.8%
14	86.8	1.7%	-9.3%
15	87.6	-5.4%	-1.3%
16	83.6	-3.3%	-9.5%

**3000K** | Rf: 88.1 | Rg: 99.7

Color Vector Graphic

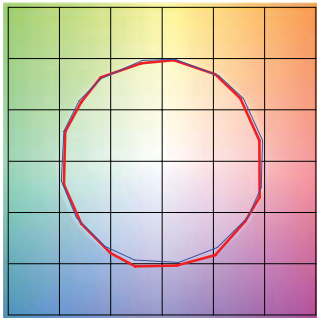

■ Test ■ Reference

HUE BIN	Rf	GRAPHIC SHIFTS %	
		CHROMA	HUE
1	92.5	-3.1%	0.3%
2	93.3	-2.3%	1.9%
3	90.9	-0.8%	3.9%
4	94.3	-1.1%	1.4%
5	92.5	-2.6%	1.5%
6	96.4	1.2%	-0.3%
7	92.6	-2.5%	-0.0%
8	96.9	-1.4%	0.2%
9	92.3	-1.8%	4.3%
10	86.6	-0.7%	7.0%
11	86.5	2.4%	8.2%
12	89.8	5.9%	1.7%
13	93.9	2.6%	-2.7%
14	89.4	5.1%	-5.8%
15	90.1	-0.1%	-4.7%
16	86.5	0.3%	-9.7%

**3500K** | Rf: 86.1 | Rg: 95.5

Color Vector Graphic

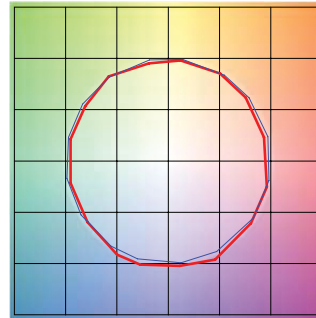

■ Test ■ Reference

HUE BIN	Rf	GRAPHIC SHIFTS %	
		CHROMA	HUE
1	90.8	-3.8%	0.3%
2	92.3	-2.8%	2.1%
3	89.7	-1.0%	4.3%
4	92.6	-1.4%	1.7%
5	91.8	-3.1%	1.3%
6	96.2	0.8%	-0.4%
7	92.9	-3.2%	0.2%
8	94.3	-2.5%	1.5%
9	90.4	-2.5%	5.2%
10	84.3	-1.4%	9.5%
11	83.1	3.5%	9.8%
12	88.2	4.8%	3.4%
13	94.0	2.7%	-2.0%
14	88.7	5.9%	-5.8%
15	88.7	0.7%	-5.9%
16	86.8	-0.7%	-6.7%

**4000K** | Rf: 87.6 | Rg: 96.8

Color Vector Graphic

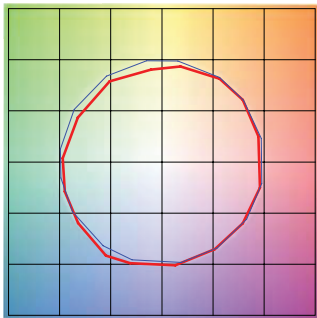

■ Test ■ Reference

HUE BIN	Rf	GRAPHIC SHIFTS %	
		CHROMA	HUE
1	88.9	-2.4%	2.5%
2	93.3	-0.4%	0.8%
3	94.8	-1.0%	-0.6%
4	87.9	-4.9%	-3.6%
5	85.3	-9.4%	-2.6%
6	90.2	-6.0%	0.2%
7	85.3	-7.6%	4.6%
8	83.7	-4.1%	8.2%
9	79.5	-1.1%	13.8%
10	78.6	1.5%	12.1%
11	83.5	6.4%	7.8%
12	90.9	3.6%	-1.1%
13	88.3	1.7%	-6.3%
14	91.9	-0.4%	-2.2%
15	84.5	-0.9%	-5.5%
16	84.7	-1.1%	-4.4%

PROJECT	FIXTURE TYPE	DATE
---------	--------------	------