

TRULINE .5A 24VDC - PLASTER-IN LED SYSTEM

REV.01.10.19

DESIGNED BY GREGORY KAY | ASSEMBLED IN AMERICA

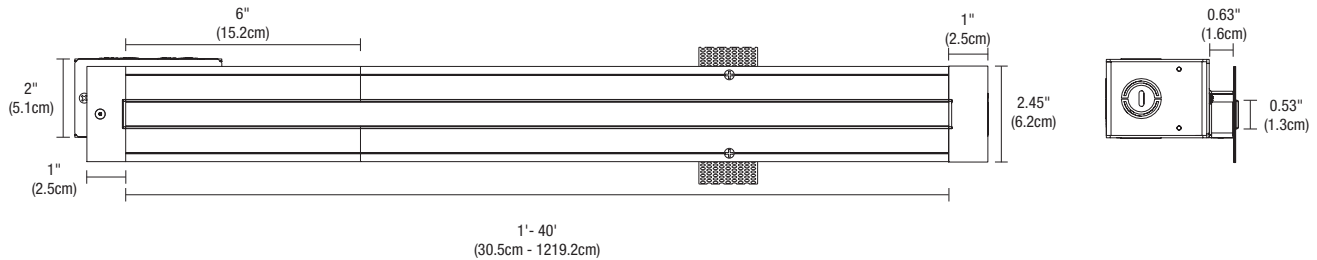
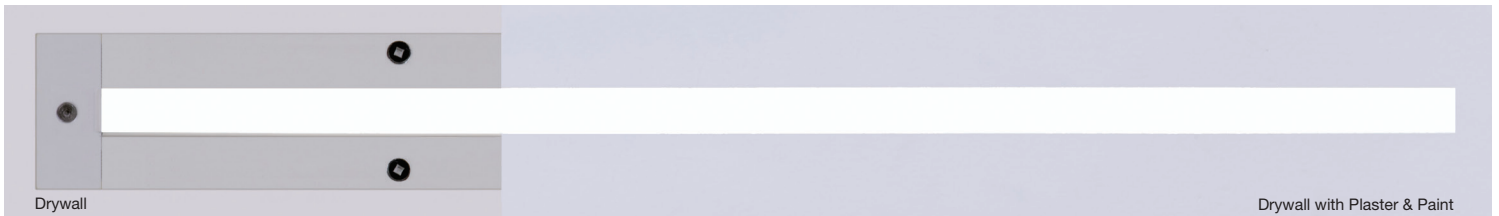

DESCRIPTION

TruLine .5A, a versatile 24VDC linear plaster-in LED system, creates a glare-free, smooth line of light, indoor architectural lighting. The system recesses into 5/8" thick drywall without joint modification. May be secured to studs that are spaced 13"-24" apart, or between studs with mounting clips provided. TruLine .5A is sold in 1' increments up to 40' (2WDC, White LEDs only), 20' (5WDC, White, 2K4K or RGB LEDs) or 16' (6WDC, RGB+W) and field cuttable to any length. Several color temperature options are available, including 2200K-5700K (ELV/010), Warm Dim (ELV), Tunable White (ELV/010/DMX), RGB and RGB+W (DMX). High CRI commercial-grade White or Dynamic Color Changing LED Soft Strip projects a clean line of light. Coordinate installation with electrician and drywall contractors. Includes a 5 year pro-rated warranty.

DESIGN NOTE

TruLine .5A can be installed on a single surface (wall or ceiling), on multiple planes that join runs from wall to ceiling, or from one wall to an adjacent wall. Use TruLine .5A Build-It-Yourself (BIY) with pre-formed components to create desired configurations including Picture Frame Miter and Room Wrapping installations. Create rectangle or square installations using TruQuad .5A.

APPLICATIONS

Indoor damp or dry locations only. General illumination and architectural accent for Kitchens, Offices, Hospitality, Retail, Residences, Libraries, Hallways, and Bath/Vanity.

LAMP

The average LED Life is 50,000 hours.

WATTS PER FOOT	LUMENS		85+CRI 22K, 35K, 40K, 57K	90+CRI 24K, 2K4K	92+CRI 27D, 30D	95+CRI 27K, 30K	RGB	RGB+W
	PER WATT	PER FOOT						
2WDC (2.5WDC)	52	169	•			•		
5WDC	50	244	•	•	•	•	•	
6WDC	N/A	N/A						•

Lumen values are based on the 3000K LED test.

REMOTE POWER SUPPLIES*, DIMMERS & CONTROLS (SOLD SEPARATELY)

- Electronic Low Voltage Dimming (ELV)
- 0-10 Volt Dimming (0-10V)
- Dynamic Color Changing (DMX)

*In-Wall Mounting Kits available for select power supplies

INCLUDED COMPONENTS

Junction Box, Adjustable Mounting Bars, TruLine .5A Channel(s), End Cap, Take-Up Box, Mounting Straps, Drywall Screws, LED Soft Strip, and Lens(es)

System	Watts Per Foot	Length in Feet	Color Temperature
TL.5A TruLine .5A	2WDC 2.5 Watts (40 ft Max) 5WDC 4.4 Watts (20 ft Max) 6WDC 6.3 Watts (16 ft Max)	40FT 1-40FT 2WDC 1-20FT 5WDC 1-16FT 6WDC	27K 22K 2200K Candle White 24K 2400K Very Warm White 27K 2700K Incandescent White 27D 2700K Warm Dim (5WDC Only) 30K 3000K Warm White (Halogen) 30D 3000K Warm Dim (Halogen, 5WDC Only) 35K 3500K Neutral White 40K 4000K Cool White 57K 5700K Daylight White 2K4K 2000K - 4000K Tunable White (5WDC Only) RGB Red, Green, and Blue (5WDC Only) RGBW Red, Green, Blue, and 2000K White (6WDC Only)

PROJECT	FIXTURE TYPE	DATE
---------	--------------	------

INCLUDED COMPONENTS

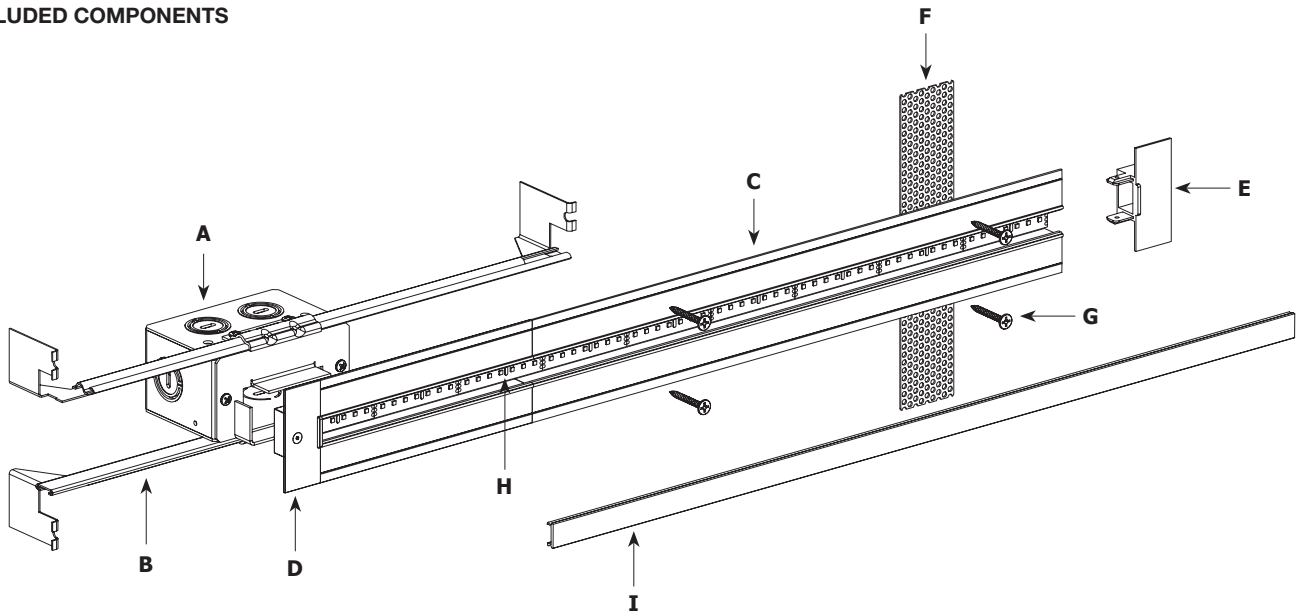

A. JUNCTION BOX

Mounts behind drywall with Adjustable Mounting Bars. Low Voltage 24VDC wires from Remote Power Supply connect to LED wires inside box. Junction Box opening is covered by channel. Required at the beginning of each run and necessary to rough-in electrical before TruLine installation. Junction Box is also included with each TruLine channel order.

B. ADJUSTABLE MOUNTING BARS

Provide flexibility for mounting in a variety of spaces and orientations. May be secured to studs that are spaced 13"-24" apart.

C. TRULINE .5A CHANNEL

5/8" deep extrusion house for a single row of LED Soft Strip.

D. POWER END CAP

Provides a finished look and prevents light leak at feed-end of run where LED Soft Strip enters channel.

E. TAKE-UP BOX

Prevents dark spots at end of run by tucking excess LED Soft Strip safely behind wall.

F. MOUNTING STRAP

Secures channel to drywall when wall stud is unavailable.

G. DRYWALL SCREW

Secures channel to drywall and stud.

H. LED SOFT STRIP

Commercial-grade White or Dynamic Color Changing LED Soft Strip.

I. LENS

0.5" wide diffuser lens projects a clean line of light without LED dots.

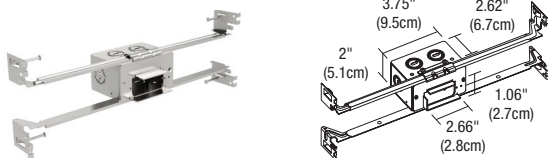

JUNCTION BOX ROUGH-IN COMPONENT

One Junction Box is included with TruLine .5A. Order additional Junction Box separately to rough-in electrical wiring before drywall installation. Quick shipment available.

System	Size	Component
TL5A	1RE	JBOX
TL5A TruLine .5A	1RE 1" Rectangle	JBOX Junction Box

PROJECT	FIXTURE TYPE	DATE
---------	--------------	------

TRULINE .5A 24VDC - PLASTER-IN LED SYSTEM

REV.01.10.19

DESIGNED BY GREGORY KAY | ASSEMBLED IN AMERICA

- APPLICATION** 0-10V dimming for TruLine .5A
- POWER SUPPLY** PSB-96W-010-24VDC (24VDC 96W output) | PSB-2X96W-010-24VDC (24VDC 2X96W output)
- DIMMING** Radio Ra2 (with GRX-TVI), Grafik Eye Qs (with GRX-TVI), Diva (with PP20); Nova T; Philips: Sunrise SR1200ZTUNV; Leviton: IP710-LF

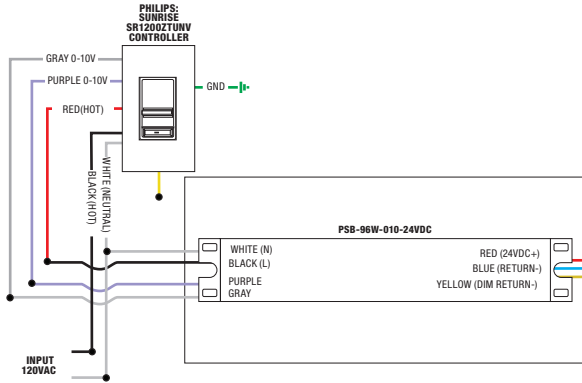

96W, 24VDC LOW VOLTAGE WIRE SIZE CHART: 3% VOLTAGE DROP

WIRE LENGTH (FT)	UP TO 33FT	34FT-52FT	53FT-86FT	87FT-130FT
WIRE SIZE	14 AWG	12 AWG	10 AWG	8 AWG
VOLTAGE AT END OF WIRE	23.28VDC	23.29VDC	23.28VDC	23.28VDC

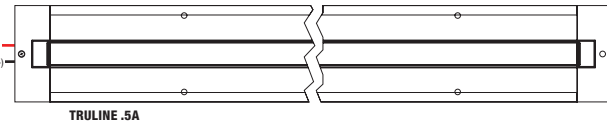

2.5 WATTS PER FOOT - 22K, 24K, 27K, 30K, 35K, 40K & 57K WHITE LEDS

LENGTH IN FEET	WATTS
1	3
2	5
3	8
4	10
5	13
6	15
7	17
8	20
9	22
10	24

LENGTH IN FEET	WATTS
11	27
12	29
13	32
14	34
15	37
16	39
17	41
18	44
19	46
20	48

LENGTH IN FEET	WATTS
21	51
22	54
23	56
24	58
25	61
26	63
27	66
28	68
29	70
30	72

LENGTH IN FEET	WATTS
31	75
32	78
33	80
34	82
35	85
36	87
37	90
38	92
39	94
40	96

5 WATTS PER FOOT - 22K, 24K, 27K, 27D, 30K, 30D, 35K, 40K, 57K, 2K4K & RGB LEDS

LENGTH IN FEET	WATTS
1	5
2	10
3	16
4	20
5	24

LENGTH IN FEET	WATTS
6	30
7	34
8	40
9	44
10	48

LENGTH IN FEET	WATTS
11	54
12	58
13	64
14	68
15	72

LENGTH IN FEET	WATTS
16	78
17	82
18	88
19	92
20	96

6 WATTS PER FOOT - RGB+W LEDS

LENGTH IN FEET	WATTS
1	6
2	12
3	18
4	24

LENGTH IN FEET	WATTS
5	30
6	36
7	42
8	48

LENGTH IN FEET	WATTS
9	54
10	60
11	66
12	72

LENGTH IN FEET	WATTS
13	78
14	84
15	90
16	96

PROJECT		FIXTURE TYPE		DATE	
---------	--	--------------	--	------	--

TRULINE .5A 24VDC - PLASTER-IN LED SYSTEM

REV.01.10.19

DESIGNED BY GREGORY KAY | ASSEMBLED IN AMERICA

TM-30-15 DATA

The data below is for SS2C and SS5C bare LED Soft Strips. Consistent color temperatures throughout a single strip and among multiple strips is possible through a 3 phase binning process in which each order is inspected with a color meter to ensure uniformity.

2200K | Rf: 83.9 | Rg: 94.9

Color Vector Graphic

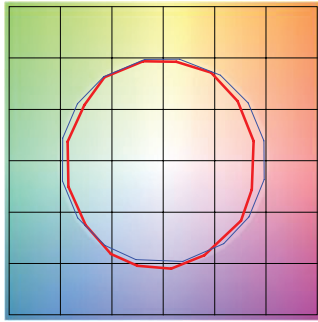

■ Test ■ Reference

		GRAPHIC SHIFTS %	
HUE BIN	Rf	CHROMA	HUE
1	77.6	-10.0%	1.8%
2	80.7	-7.5%	7.0%
3	79.5	-2.9%	8.9%
4	90.5	-3.1%	2.4%
5	93.9	-1.3%	1.9%
6	91.9	-0.9%	-0.2%
7	87.6	-6.3%	-2.7%
8	90.5	-5.4%	2.7%
9	83.8	-4.7%	6.5%
10	81.2	-2.5%	10.0%
11	83.3	3.9%	9.4%
12	86.4	5.6%	2.6%
13	86.2	4.5%	-12.4%
14	64.3	-1.0%	-21.9%
15	85.1	-4.4%	-7.5%
16	75.0	-9.9%	-12.0%

2400K | Rf: 84.5 | Rg: 94.4

Color Vector Graphic

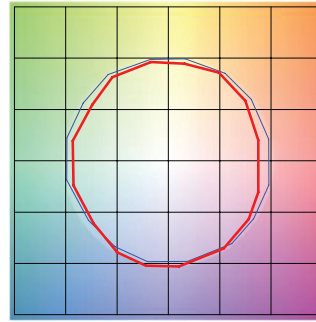

■ Test ■ Reference

		GRAPHIC SHIFTS %	
HUE BIN	Rf	CHROMA	HUE
1	81.1	-7.7%	3.0%
2	84.9	-5.7%	4.9%
3	85.3	-2.3%	6.1%
4	87.7	-5.5%	-0.5%
5	92.5	-3.9%	0.5%
6	91.1	-3.4%	0.1%
7	86.0	-7.7%	0.5%
8	87.1	-6.0%	4.3%
9	80.1	-3.9%	9.8%
10	79.0	-0.9%	11.8%
11	82.3	5.5%	10.1%
12	87.6	5.4%	-0.5%
13	84.7	3.3%	-12.0%
14	78.0	0.8%	-13.7%
15	86.9	-5.5%	-4.3%
16	78.1	-7.5%	-10.8%

2700K | Rf: 87.7 | Rg: 96.1

Color Vector Graphic

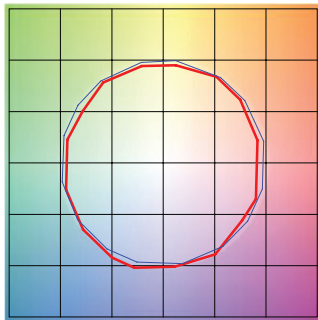

■ Test ■ Reference

		GRAPHIC SHIFTS %	
HUE BIN	Rf	CHROMA	HUE
1	86.4	-5.6%	2.3%
2	89.7	-3.3%	3.1%
3	90.5	-1.5%	3.8%
4	90.0	-4.3%	1.1%
5	92.9	-3.7%	0.2%
6	93.5	-2.5%	-0.8%
7	86.3	-7.2%	2.5%
8	90.7	-4.0%	3.2%
9	85.2	-2.4%	8.1%
10	81.7	0.9%	10.8%
11	85.4	4.5%	8.9%
12	88.7	5.7%	-1.4%
13	88.3	1.3%	-7.9%
14	85.1	2.4%	-10.4%
15	88.1	-4.8%	-2.7%
16	81.7	-4.3%	-10.9%

3000K | Rf: 88.1 | Rg: 99.7

Color Vector Graphic

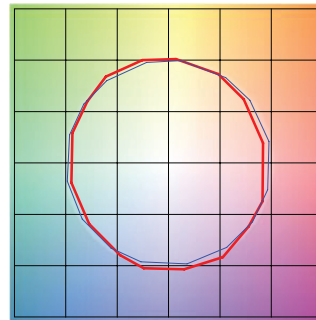

■ Test ■ Reference

		GRAPHIC SHIFTS %	
HUE BIN	Rf	CHROMA	HUE
1	87.7	-5.9%	-0.3%
2	87.9	-4.4%	4.3%
3	82.9	-1.2%	7.9%
4	89.9	0.6%	4.7%
5	92.7	3.0%	3.5%
6	92.7	3.6%	-1.7%
7	90.8	-1.3%	-4.4%
8	93.7	-2.5%	-2.2%
9	91.7	-3.7%	2.3%
10	85.5	-2.8%	7.8%
11	83.3	0.7%	11.0%
12	86.4	5.5%	3.8%
13	90.6	4.6%	-3.6%
14	85.6	5.9%	-8.4%
15	89.5	-0.6%	-5.7%
16	82.6	-2.7%	-12.0%

3500K | Rf: 86.1 | Rg: 95.5

Color Vector Graphic

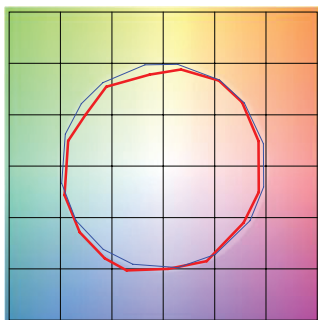

■ Test ■ Reference

		GRAPHIC SHIFTS %	
HUE BIN	Rf	CHROMA	HUE
1	86.6	-4.2%	3.4%
2	91.7	-1.4%	1.8%
3	94.9	-0.7%	0.4%
4	87.9	-4.5%	-4.1%
5	85.9	-10.3%	-2.7%
6	89.8	-5.2%	-0.4%
7	79.6	-9.5%	6.5%
8	87.6	-4.0%	5.7%
9	81.4	-0.5%	11.8%
10	78.3	3.3%	11.4%
11	85.7	6.3%	6.1%
12	86.3	7.1%	-4.6%
13	86.1	-0.7%	-9.6%
14	85.1	0.8%	-10.4%
15	83.4	-4.1%	-5.3%
16	82.5	-3.6%	-5.7%

4000K | Rf: 87.6 | Rg: 96.8

Color Vector Graphic

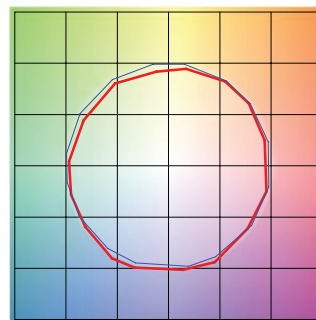

■ Test ■ Reference

		GRAPHIC SHIFTS %	
HUE BIN	Rf	CHROMA	HUE
1	89.0	-3.1%	2.1%
2	93.2	-0.9%	1.3%
3	94.3	-1.1%	0.7%
4	89.5	-4.0%	-2.3%
5	87.6	-7.8%	-1.8%
6	92.2	-4.6%	0.1%
7	87.4	-6.6%	3.6%
8	85.7	-3.8%	7.0%
9	81.5	-1.3%	12.4%
10	80.0	0.9%	11.4%
11	83.3	5.9%	8.7%
12	89.7	4.8%	-0.3%
13	88.5	2.4%	-6.3%
14	92.7	4.0%	-3.8%
15	86.1	-1.6%	-4.5%
16	85.0	-1.4%	-5.0%

PROJECT		FIXTURE TYPE		DATE	
---------	--	--------------	--	------	--

TRULINE .5A 24VDC - PLASTER-IN LED SYSTEM

REV.01.10.19

DESIGNED BY GREGORY KAY | ASSEMBLED IN AMERICA

TM-30-15 DATA

The data below is for SS2C and SS5C bare LED Soft Strips. Consistent color temperatures throughout a single strip and among multiple strips is possible through a 3 phase binning process in which each order is inspected with a color meter to ensure uniformity.

5700K | Rf: 80.3 | Rg: 91.5

Color Vector Graphic

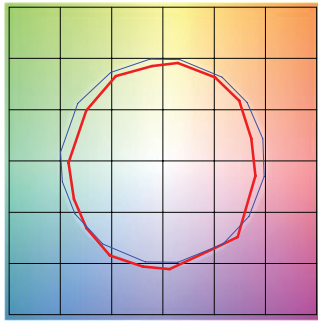

■ Test ■ Reference

		GRAPHIC SHIFTS %	
HUE BIN	Rf	CHROMA	HUE
1	73.8	-11.2%	2.6%
2	83.7	-5.5%	5.8%
3	84.2	-4.0%	5.5%
4	85.8	-3.5%	1.3%
5	85.3	-7.1%	0.6%
6	89.2	-5.8%	-2.2%
7	81.5	-10.7%	1.2%
8	75.7	-9.7%	8.5%
9	74.9	-7.8%	18.8%
10	67.8	-1.6%	18.0%
11	76.1	5.5%	12.0%
12	90.8	4.9%	-1.6%
13	83.6	5.0%	-9.5%
14	81.7	-1.2%	-10.0%
15	69.0	2.0%	-22.8%
16	83.2	-8.5%	-1.0%

2K4K (3000K) | Rf: 90.2 | Rg: 101.4

Color Vector Graphic

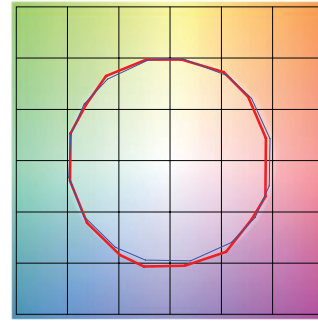

■ Test ■ Reference

		GRAPHIC SHIFTS %	
HUE BIN	Rf	CHROMA	HUE
1	90.9	-3.8%	1.3%
2	91.7	-1.9%	3.3%
3	88.7	0.7%	5.1%
4	92.4	-1.0%	0.7%
5	92.9	0.9%	1.7%
6	93.1	3.3%	-0.6%
7	91.0	-1.8%	-0.4%
8	97.0	0.2%	-1.1%
9	92.8	-0.5%	3.6%
10	88.3	1.0%	7.0%
11	87.1	3.8%	7.8%
12	87.6	6.5%	-0.3%
13	89.3	3.6%	-6.3%
14	86.1	4.5%	-9.1%
15	91.6	-1.9%	-3.1%
16	83.8	-1.5%	-11.2%

2000K ONLY (2K4K) | Rf: 84.3 | Rg: 96.9

Color Vector Graphic

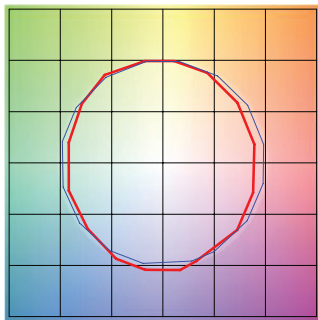

■ Test ■ Reference

		GRAPHIC SHIFTS %	
HUE BIN	Rf	CHROMA	HUE
1	80.3	-8.9%	1.7%
2	79.7	-7.0%	7.8%
3	78.9	-2.9%	10.0%
4	89.5	-0.5%	5.1%
5	94.4	0.7%	1.7%
6	92.1	2.4%	-0.3%
7	89.4	-2.4%	-5.9%
8	89.7	-6.4%	-0.2%
9	86.0	-4.9%	4.6%
10	81.8	-3.4%	9.3%
11	83.1	3.3%	9.7%
12	85.8	5.6%	3.3%
13	85.6	6.2%	-12.8%
14	61.7	-1.9%	-19.0%
15	79.7	-3.3%	-12.9%
16	78.1	-7.9%	-10.6%

4000K ONLY (2K4K) | Rf: 89.6 | Rg: 99.1

Color Vector Graphic

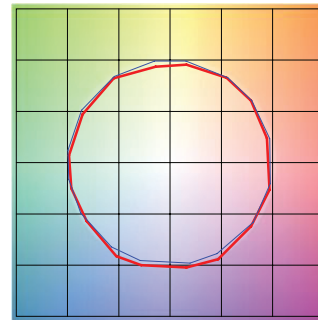

■ Test ■ Reference

		GRAPHIC SHIFTS %	
HUE BIN	Rf	CHROMA	HUE
1	91.3	-2.5%	1.0%
2	95.3	-0.5%	0.5%
3	94.3	-0.7%	1.1%
4	91.1	-3.4%	-1.1%
5	89.5	-5.6%	0.0%
6	94.6	-1.4%	1.3%
7	93.2	-3.0%	2.6%
8	91.3	-1.8%	4.6%
9	86.5	-0.9%	9.1%
10	83.3	-0.5%	9.5%
11	83.3	4.9%	9.0%
12	89.7	4.1%	1.7%
13	90.1	3.6%	-4.3%
14	93.4	5.2%	-2.1%
15	87.4	0.4%	-4.3%
16	86.6	0.4%	-6.1%

2700D | Rf: 89.5 | Rg: 100.8

Color Vector Graphic

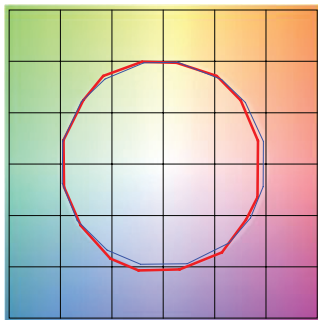

■ Test ■ Reference

		GRAPHIC SHIFTS %	
HUE BIN	Rf	CHROMA	HUE
1	88.8	-5.1%	1.4%
2	89.8	-2.7%	4.1%
3	87.2	0.3%	5.9%
4	92.3	-0.9%	1.0%
5	93.3	1.5%	1.7%
6	92.4	3.6%	-0.2%
7	92.2	-0.9%	-2.4%
8	96.7	-0.4%	-1.1%
9	92.3	-1.2%	3.7%
10	88.9	-0.0%	6.1%
11	86.4	5.1%	7.4%
12	88.2	6.3%	-0.9%
13	87.2	3.8%	-8.1%
14	84.2	3.8%	-11.0%
15	89.8	-2.6%	-4.3%
16	82.7	-3.4%	-11.1%

3000D | Rf: 89.8 | Rg: 101.4

Color Vector Graphic

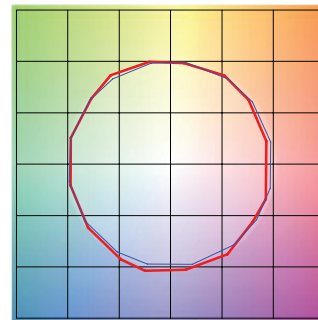

■ Test ■ Reference

		GRAPHIC SHIFTS %	
HUE BIN	Rf	CHROMA	HUE
1	90.2	-4.2%	1.5%
2	90.9	-2.0%	3.7%
3	87.9	0.8%	5.5%
4	92.1	-0.9%	0.6%
5	93.0	1.5%	1.6%
6	92.2	3.9%	-0.2%
7	92.1	-0.3%	-2.0%
8	96.7	0.0%	-1.2%
9	92.5	-0.6%	3.7%
10	88.3	1.1%	7.0%
11	87.2	4.1%	7.4%
12	87.2	6.7%	-1.0%
13	88.2	3.8%	-7.2%
14	85.3	4.3%	-9.9%
15	90.9	-2.2%	-3.6%
16	83.4	-2.2%	-11.2%

PROJECT		FIXTURE TYPE		DATE	
---------	--	--------------	--	------	--