



VANISHING POINT 12VAC MONOPOINT PENDANT & SUSPENSION

FAST JACK 0.15" COAXIAL CABLE CONNECTION SYSTEM, NEW CONSTRUCTION



DESIGNED BY GREGORY KAY | ASSEMBLED IN AMERICA | US PATENT PENDING

REV 10.13.22

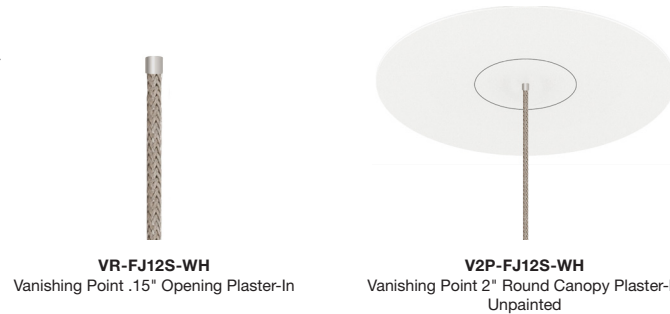
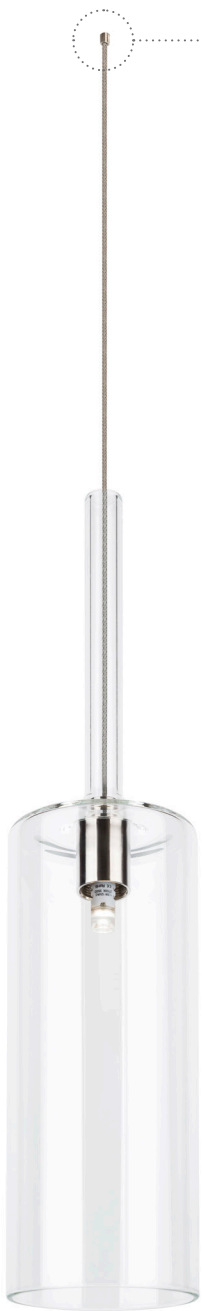

V2MR-FJ12S-BZ
Vanishing Point 2" Flush Canopy for Millwork Ceiling, with ELV power supply in J-Box

DESCRIPTION

The Vanishing Point 12VAC Monopoint Pendant and Suspension connection system is a groundbreaking advancement to the way the world sees any luminaire. Setting a new standard in refinement, the Vanishing Point eliminates the unsightly, outdated canopy we have all grown accustomed to. Compatible with any **12V Fast Jack Coaxial Pendant or Suspension**, it is the only Truly Trimless and flush design available on the market, as the connection point Disappears into the ceiling. The system offers four distinct mounting options for Drywall and Millwork, allowing any space to achieve a minimal and continuous architecture. Patent Pending. New Construction applications only.

DRYWALL APPLICATIONS (PLASTER-IN)

VR - Remote Power Supply has NO visible canopy line, just the small (.15") point of connection where the fast jack disappears into the ceiling. 12V remote power supply (Order Separately).

V2P - ELV power supply fits within the junction box. The paintable, plaster-in plate allows for the slightest outline of the 2.0" round canopy. 12 VAC/50W IC or 60W Non-IC ELV.

MILLWORK APPLICATIONS

V2MR - Connection point at ceiling 2.0" canopy sits flush in Millwork ceilings for a clean look. 12V remote power supply (order separately).

V2MP - Connection point at ceiling 2.0" canopy sits flush in Millwork ceilings. Power supply fits inside J-BOX is included. 12 VAC/50W IC or 60W Non-IC ELV.

CONNECTION TYPES

Compatible with any 12 volt fast jack, free jack, EZ jack, quick connect or Unijack, fixture. Or add our Fast Jack connector (**FJ-MC-SN**) to any 12V pendant or suspension on a coaxial cable.

WARRANTY / LABELS

Pro-rated 5 year warranty. Assembled in America
ETL (Conforms to UL1598 and CSA 22.2 #250.0)

APPLICATIONS

Designed for New Construction, indoor use only. Ideal applications in residential, commercial, retail and hospitality environments.

System	Type/Voltage	Finish
VR	FJ12S	WH

VR Vanishing Point 0.15" Connection Plaster in to Drywall, No Outline of Canopy at connection point. Remote Power Supply
V2P Vanishing Point 2.0" Connection Drywall flush mount canopy outline will show. ELV power supply included with J-Box
V2MP Vanishing Point 2.0" Flush-Mount Canopy, ELV 60W Power Supply fits in J-BOX, for use with Mill-Work
V2MR Vanishing Point 2.0" Millwork Flush-Mount Canopy, Remote Power Supply, for use with Mill-Work.
 *Vanishing Point 12VAC Fast Jack System is for New Construction applications only

FJ12S Fast Jack 12VAC Connection

WH White
BK Black
SN Satin Nickel
BZ Bronze

PROJECT	FIXTURE TYPE	DATE



VANISHING POINT 12VAC MONOPOINT PENDANT & SUSPENSION

FAST JACK 0.15" COAXIAL CABLE CONNECTION SYSTEM, NEW CONSTRUCTION



REV 10.13.22



To Remote Power Supply (not included, see page 4)

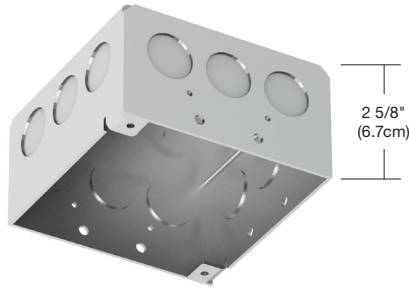

TE-60L-12 Power Supply fits in J-Box



To Remote Power Supply (not included, see page 4)



VR-FJ12S

Vanishing Point Flush to dry wall, plaster in and paint, with Remote Power

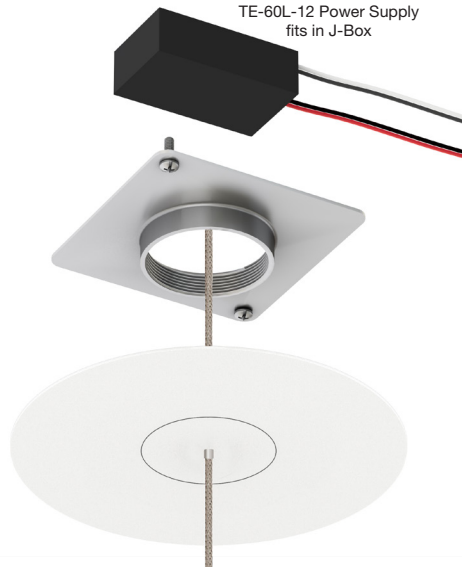

V2P-FJ12S

Vanishing Point 2" Flush Canopy to dry wall, plaster in and paint, with ELV power supply in J-Box



V2MR-FJ12S

Vanishing Point 2" Flush Canopy for Millwork with Remote Power

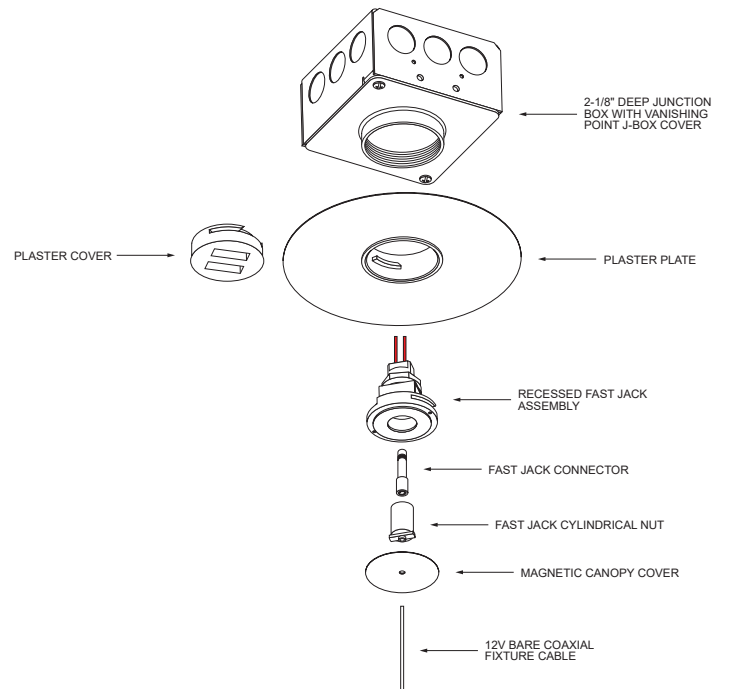
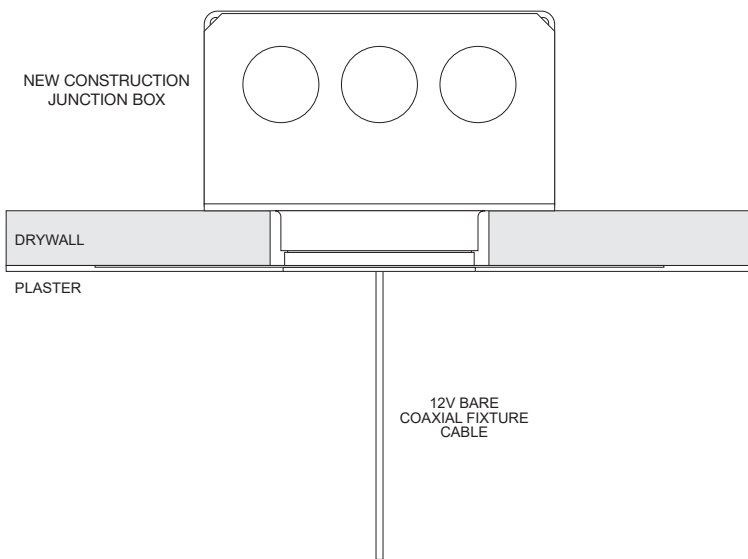

PROJECT	FIXTURE TYPE	DATE
---------	--------------	------

MONOPOINT PENDANT & SUSPENSION

FAST JACK 0.15" COAXIAL CABLE CONNECTION SYSTEM, NEW CONSTRUCTION - COMPATIBLE PURE EDGE PENDANTS

SALUTI

FJ12 VANISHING POINT CONNECTOR



FJ-SALUTI-SM-GY-SN
Small (3" diameter) Gray



FJ-SALUTI-MD-CR-SN
Medium (4" diameter) Crystal



FJ-SALUTI-LG-GY-SN
Large (5.5" diameter) Gray

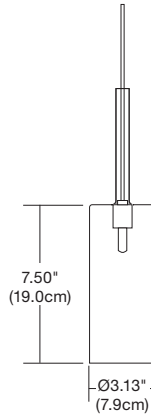

Small

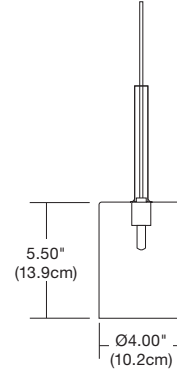

Medium

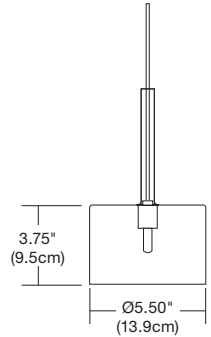

Large

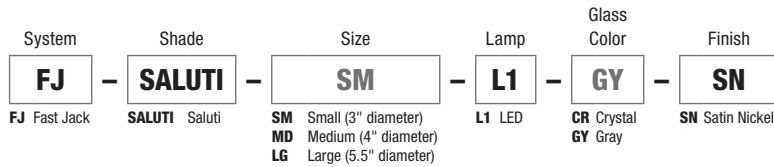

BUBBLE BALL

FJ12 VANISHING POINT CONNECTOR



FJ-BBCL27-10FT-12-SN
Clear

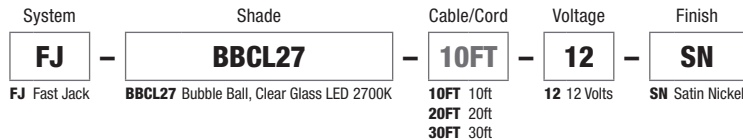
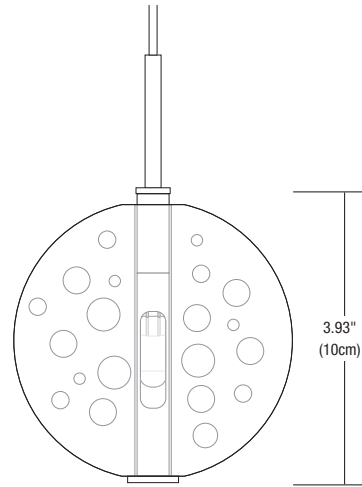

PROJECT	FIXTURE TYPE	DATE
---------	--------------	------

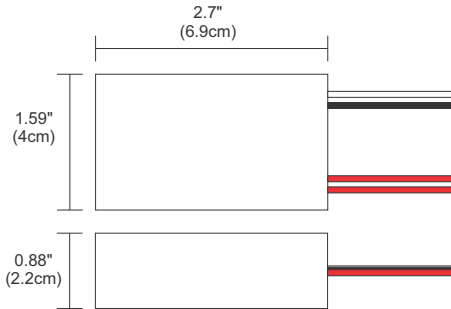

REMOTE 60W 12VAC CLASS 2 POWER SUPPLY

TE-60L-12 60 Watt 12VAC Electronic Transformer converts 120 volt line voltage to 12 volts and features built-in short-circuit protection. The solid, lightweight remote power supply fits inside a standard electrical junction box behind a power feed canopy. Must be in an accessible location or inside an electrical box. Must be within 10' of lamp, max six 9 watt fixtures.

- No load technology, works with LED AC loads
- Isolated output power per NEC and UL safety requirements
- UL recognized/listed Class 2 power supply, meets UL 2108 requirements
- Auto-reset; Short circuit, Overload and Thermal protection
- Soft start
- Dimmable with ELV dimmer

System	Power	Voltage Output
TE	60L	12
<small>TE Transformer Electronic</small>	<small>60L 60 Watts</small>	<small>12 12 Volt AC</small>

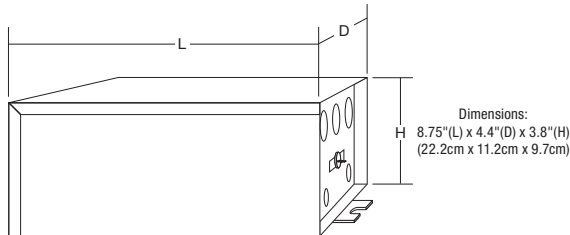

REMOTE MAGNETIC TRANSFORMER UL2108 150W AND 300W 12VAC POWER SUPPLY (SOLD SEPARATELY)

The 150 watt or 300 watt 12 Volt Remote Magnetic Transformer converts 120VAC line voltage into 12VAC low voltage power and are protected by fast-acting circuit breakers. The low voltage output powers the Vanishing Point System up to 300 watts using LED MR16 12V lamps, 8 watts max per connection. Power up to 30 Vanishing Point fixtures using a single power supply at 300 Watts and 9 Watts per Lamp. Dimmable with Magnetic Low Voltage Dimmer sold separately.

System	Power	Voltage Output
T	300	12
<small>T Transformer Magnetic</small>	<small>150 150 Watt Magnetic Remote Transformer 300 300 Watt Magnetic Remote Transformer</small>	<small>12 12 Volt AC</small>

PROJECT	FIXTURE TYPE	DATE
---------	--------------	------