

DESCRIPTION

Zipp Suspension Downlight with Remote 24VDC power supply is a linear LED fixture that offers spot-free, direct light in a clean, contemporary style. Zipp is available in various lengths from 12" to 480" (40'), a 100° beam spread, optional louver for additional diffusion and a variety of finishes. Fixture includes a 5-year warranty. For custom designs and quotes, send drawings to design@PureEdgeLighting.com.

Wattages for this fixture are available in the following options:

- 2W - 2.5 watts per foot, lengths up to 480" (40') before re-feeding
- 5W - 5 watts per foot, lengths up to 240" (20') before re-feeding
- 7W - 7.5 watts per foot, lengths up to 144" (12') before re-feeding

INSTALLATION

- Includes your choice of one or 2 canopies; one for remote power, one blank - 2R2, 2S2, 4R2, 4S2
- Adjustable 12' coaxial and aircraft cables included; additional aircraft cables included for support when fixture exceeds 96"

LENSES

- Available in a Diffused White Lens with 100° beam spread or Clear Frosted Lens at 60° beam spread with Louver
- Optional black louver available for both lenses

FINISHES

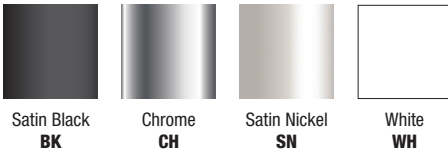

APPLICATIONS

Designed for indoor use only. Ideal applications in Commercial, Retail, Residential, Hospitality, Education, and Healthcare Institutions.

LAMPING

- Choose from 11 color temperatures from 2400K-4000K including Warm Dim
- Warm Dim (optional): 2700K to 2000K (**27D**) or 3000K to 2000K (**30D**)
- 50,000 Hour Lamp Life

REMOTE POWER SUPPLIES*, DIMMERS & CONTROLS (SOLD SEPARATELY)

24VDC, Class 2 wiring

Static White & Warm Dim

- [UNI Driver: Universal Dimming \(TRIAC, ELV, 0-10V\)](#)

Lutron

- [Lutron Hi-Lume/Ecosystem](#)

*In-Wall Mounting Kits available for select power supplies

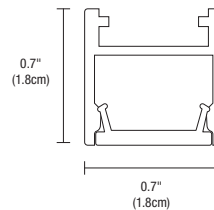

Channel Without Louver (Actual Size)

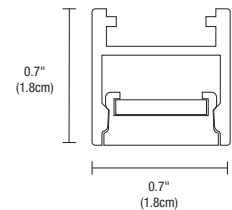

Channel With Louver (Actual Size)

System	Wattage Per Foot	Canopy	Nominal Size	Color Temperature	Finish
ZSD	2W	2R	480	30K	SN
ZSD Zipp Suspension Diffused Lens without Louver ZSDB Zipp Suspension Diffused Lens with Black Louver ZSCB Zipp Suspension Clear Frosted Lens with Black Louver	2W 2.5 Watts (480" Max, 40ft) 5W 5 Watts (240" Max, 20ft) 7W 7.5 Watts (144" Max, 12ft)	2R 2.8" Round Canopy 2S 2.8" Square Canopy 4R 4.6" Round Canopy 4S 4.6" Square Canopy 2R2 2x2.8" Round Canopy 2S2 2x2.8" Square Canopy 4R2 2x4.6" Round Canopy 4S2 2x4.6" Square Canopy VR Vanishing Point Plaster in system with No Canopy	12-480 Order in various increments from 12" to 480" *Maximum shipping length is 120"; Maximum shipping length for Chrome is 84". *See length chart for exact dimensions	24K 2400K Very Warm White 27K 2700K Incandescent White 27D 2700K Warm Dim (5W only) 30K 3000K Warm White (Halogen) 30D 3000K Warm Dim (Halogen, 5W only) 35K 3500K Neutral White 40K 4000K Cool White	BK Satin Black CH Chrome SN Satin Nickel WH White

PROJECT	FIXTURE TYPE	DATE
---------	--------------	------

Lamp Data: Lamp data for Downlight Channel

ZSD																	
DESCRIPTION	100° DIFFUSED WHITE LENS WITHOUT LOUVER																
WATTS PER FOOT	2W (2.5 watts)					5W (4.4 watts)					7W (7.5 watts)						
COLOR TEMPERATURE	24K	27K	30K	35K	40K	24K	27K	27D*	30K	30D*	35K	40K	24K	27K	30K	35K	40K
LUMENS PER FOOT (lm/ft)	143	145	151	173	182	265	268	305	279	318	320	337	409	413	430	494	521
LUMENS PER WATT (lm/w)	57	58	60	69	73	60	61	64	63	66	73	77	56	57	59	68	71
CRI	92+	92+	92+	92+	92+	92+	92+	94+	92+	94+	92+	92+	92+	92+	92+	92+	92+

*27D, 30D - Warm Dim (4.8 Watts)

ZSDB																	
DESCRIPTION	100° DIFFUSED WHITE LENS WITH BLACK LOUVER																
WATTS PER FOOT	2W (2.5 watts)					5W (4.4 watts)					7W (7.5 watts)						
COLOR TEMPERATURE	24K	27K	30K	35K	40K	24K	27K	27D*	30K	30D*	35K	40K	24K	27K	30K	35K	40K
LUMENS PER FOOT (lm/ft)	55	55	57	66	69	101	102	116	106	121	122	128	156	157	164	188	198
LUMENS PER WATT (lm/w)	22	22	23	26	28	23	23	24	24	25	28	29	21	22	22	26	27
CRI	92+	92+	92+	92+	92+	92+	92+	94+	92+	94+	92+	92+	92+	92+	92+	92+	92+

*27D, 30D - Warm Dim (4.8 Watts)

ZSCB																	
DESCRIPTION	60° CLEAR FROSTED WHITE LENS WITH BLACK LOUVER																
WATTS PER FOOT	2W (2.5 watts)					5W (4.4 watts)					7W (7.5 watts)						
COLOR TEMPERATURE	24K	27K	30K	35K	40K	24K	27K	27D*	30K	30D*	35K	40K	24K	27K	30K	35K	40K
LUMENS PER FOOT (lm/ft)	64	64	67	77	81	118	119	136	124	141	142	150	182	184	191	219	231
LUMENS PER WATT (lm/w)	25	26	27	31	32	27	27	28	28	29	32	34	25	25	26	30	32
CRI	92+	92+	92+	92+	92+	92+	92+	94+	92+	94+	92+	92+	92+	92+	92+	92+	92+

*27D, 30D - Warm Dim (4.8 Watts)

5W DIFFUSED WHITE			
Distance	Foot Candles 5W	Beam Width Vert. Spread 101.1°	Beam Width Horiz. Spread 97.4°
1.7ft	120fc	4.1ft	3.9ft
3.3ft	39fc	8.0ft	7.5ft
5.0ft	16fc	12.1ft	11.4ft
6.7ft	10fc	16.3ft	15.3ft
8.3ft	6fc	20.2ft	18.9ft
10.0ft	4fc	24.3ft	22.8ft

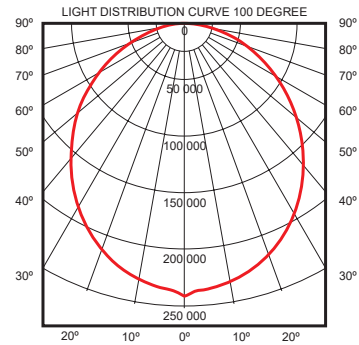

Shown without Louver

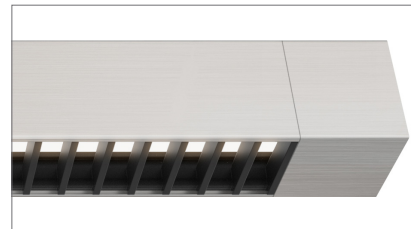

Shown with Black Louver

PROJECT		FIXTURE TYPE		DATE	
---------	--	--------------	--	------	--

COMPONENTS Swag Bar & Hook, Swag Hook, and T-Bar are compatible with all Power Canopy options and may be required based on lighting design and application

NEW CONSTRUCTION & REMODEL 2" COVER FOR 4" SQUARE JUNCTION BOX

The New Construction NC2-JBOX Cover is included with the 2" Round and Square Canopies and is not required for the 4" Square Canopies. NC2 New Construction Junction Box Cover mounts to a standard 4" Electrical Box or Octagon Box, converting it to a 2" Plaster Ring for use with the 2R (Round) or 2S (Square) Canopy. The Remodel RM2-JBOX Plaster Plate cover is used with an existing 4" Square Junction Box and standard Round Plaster Ring. The PS-60L-ELV-24VDC (50 Watt IC, 60 Watt Non-IC) will fit inside the NC2 or RM2-JBOX Cover and Electrical Junction Box for a flush look.

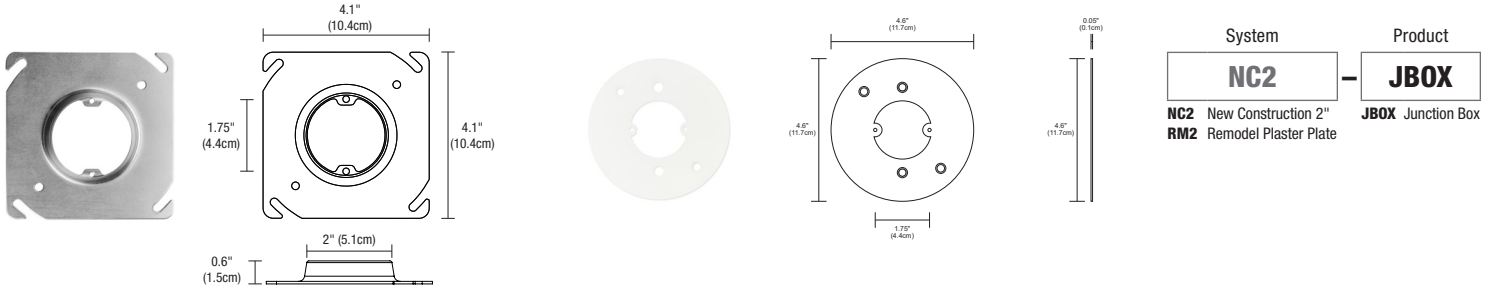

ZIPP REMOTE POWER CANOPIES (INCLUDED)

Canopies are included with Canopy ordering code. The 2" Round and Square Canopy includes a special Plaster Ring NC2-JBOX (above). The 4" Square or Round Canopy fits on a standard 4" Electrical Box with Round Plaster Ring and the PS-60L-ELV-24VDC 50 Watt IC, 60 Watt Non-IC) will fit inside the NC2 or RM2-JBOX Cover and Electrical Junction Box for a flush look. Vanishing Point Plaster in system with No Canopy, only see cable going through drywall ceiling with GJ24.

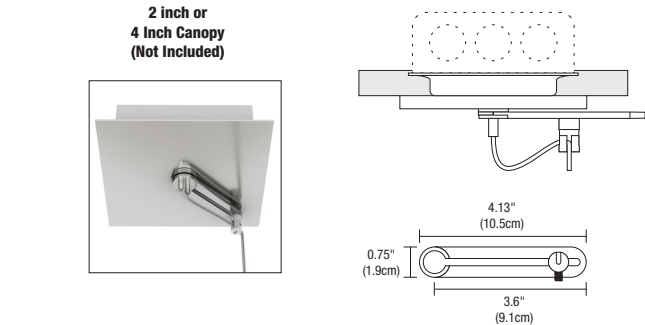
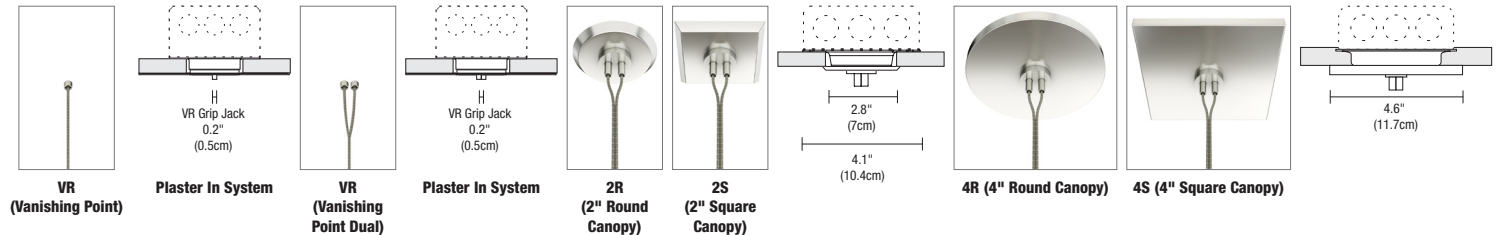

CHANNEL SUSPENSION ADJUSTABLE SWAG BAR AND HOOK

Channel Suspension Adjustable Swag Bar and Hook allows a cable to form a straight connection to the channel when the Power Canopy is not located directly above the fixture. Use when you have two or more canopies (power supplies) on the same fixture run. The Adjustable Swag Hook is compatible with the 2R, 2S, 4R and 4S Power Canopies (Canopy not included).

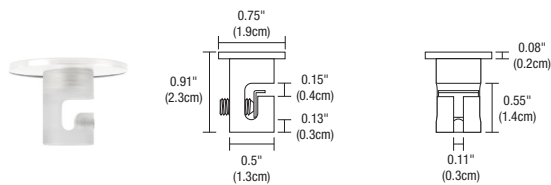
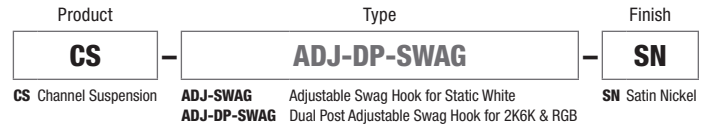

CHANNEL SUSPENSION SWAG HOOK

The clear plastic Swag Hook extends a cable from an electrical box that is not located directly above desired fixture location.

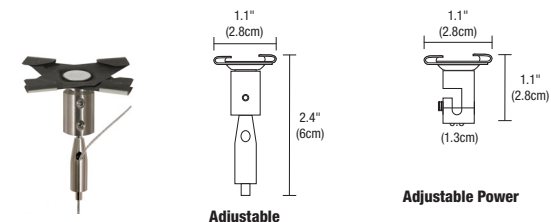
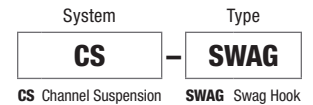

CHANNEL SUSPENSION ADJUSTABLE T-BAR CLIP

Channel Suspension Adjustable T-Bar Clip mounts to T-Bar grid ceilings. Available in Satin Nickel Hardware as Adjustable Power and Non-Power versions.

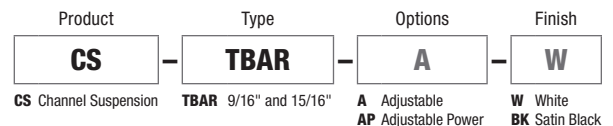

PROJECT	FIXTURE TYPE	DATE
---------	--------------	------

Drawings: Drawings are shown with 2" round canopy, 2" square canopy, 4" round canopy, and 4" square canopy

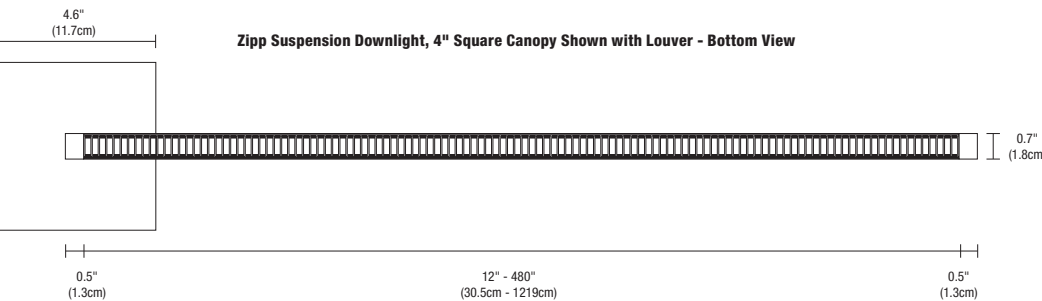
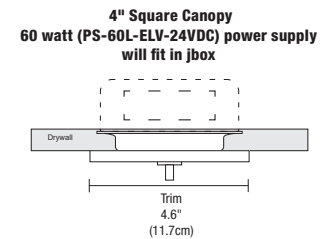
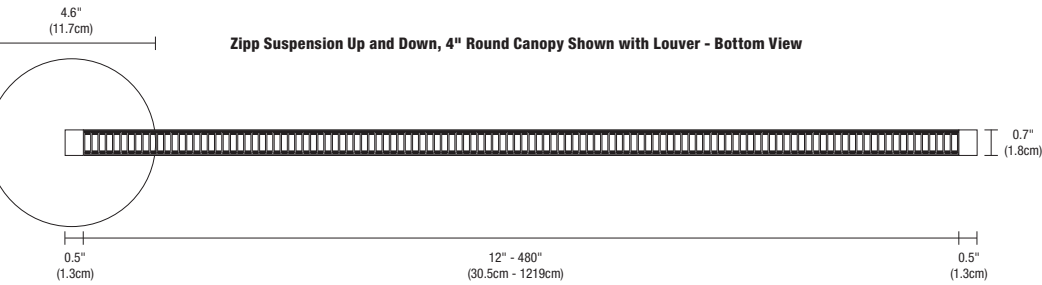
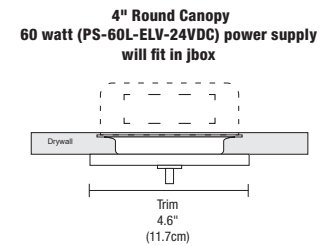
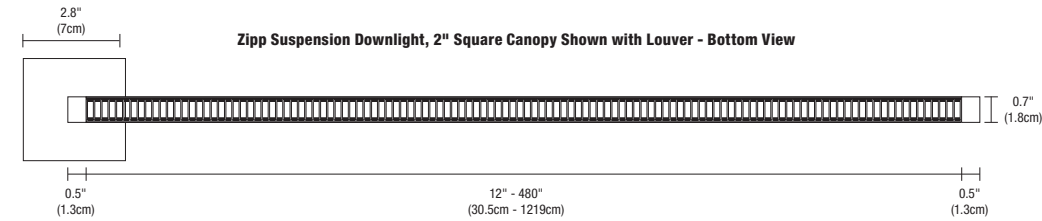
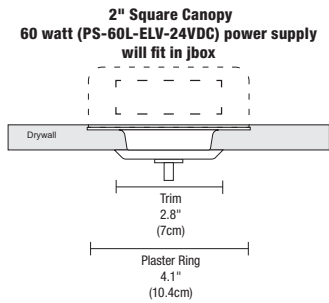
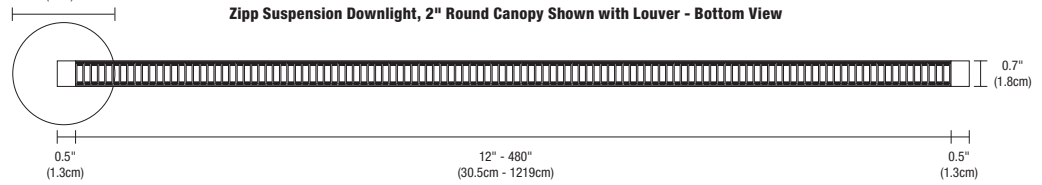
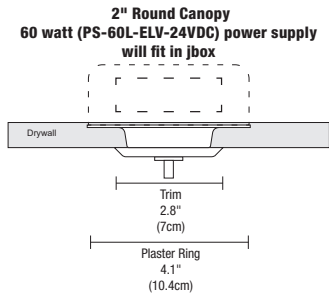

PROJECT	FIXTURE TYPE	DATE
---------	--------------	------

Drawings: Side-view shown with two 2" and 4" canopies; one for remote power, one blank

Zipp Suspension Downlight with Remote Power 4R2, 4S2, 4" Canopy Shown with Louver

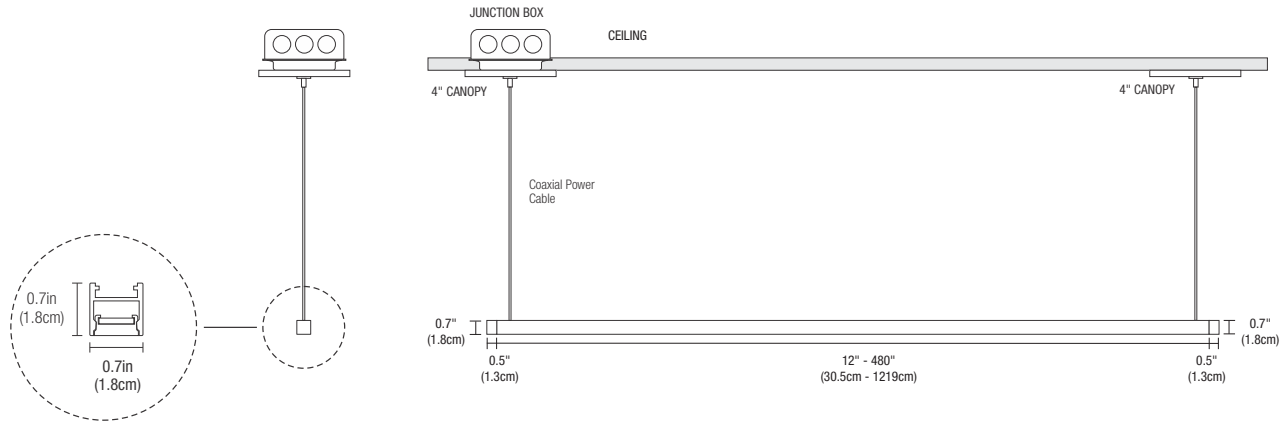

Zipp Suspension Downlight with Remote Power 2R2, 2S2, 2 inch Canopy Shown with Louver

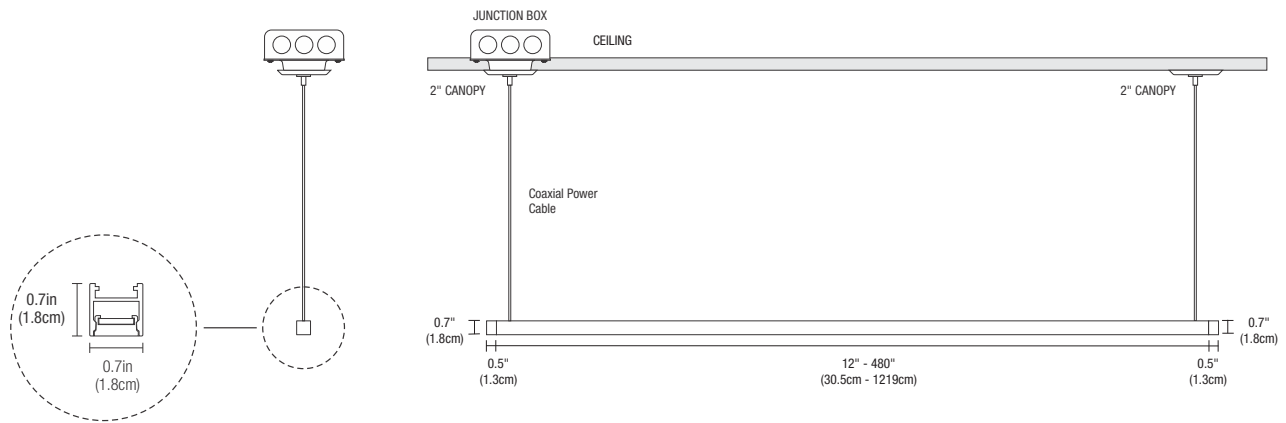

PROJECT	FIXTURE TYPE	DATE

Wiring Diagram: Wiring diagram for Static White with ELV Dimmer

- Application:** ELV dimming for Zipp Suspension Downlight, End Feed Canopy, Static White
- Power Supply:** Class 2, 24VDC output: 120VAC input, PS-60L-ELV-24VDC (Fits in Jbox)
- Remote Power Supplies:** PSB-60W-ELV-24VDC, PSB-100W-ELV-24VDC, UL 2108: PSB-200W-ELV-24VDC
- Dimming:** Dimmable with ELV dimmer: Legrand, Adorne ADTP703TU; Lutron: Diva DVELV-300P, Skylark SELVz-300P, Maestro MAELV-600 and Radio Ra 2

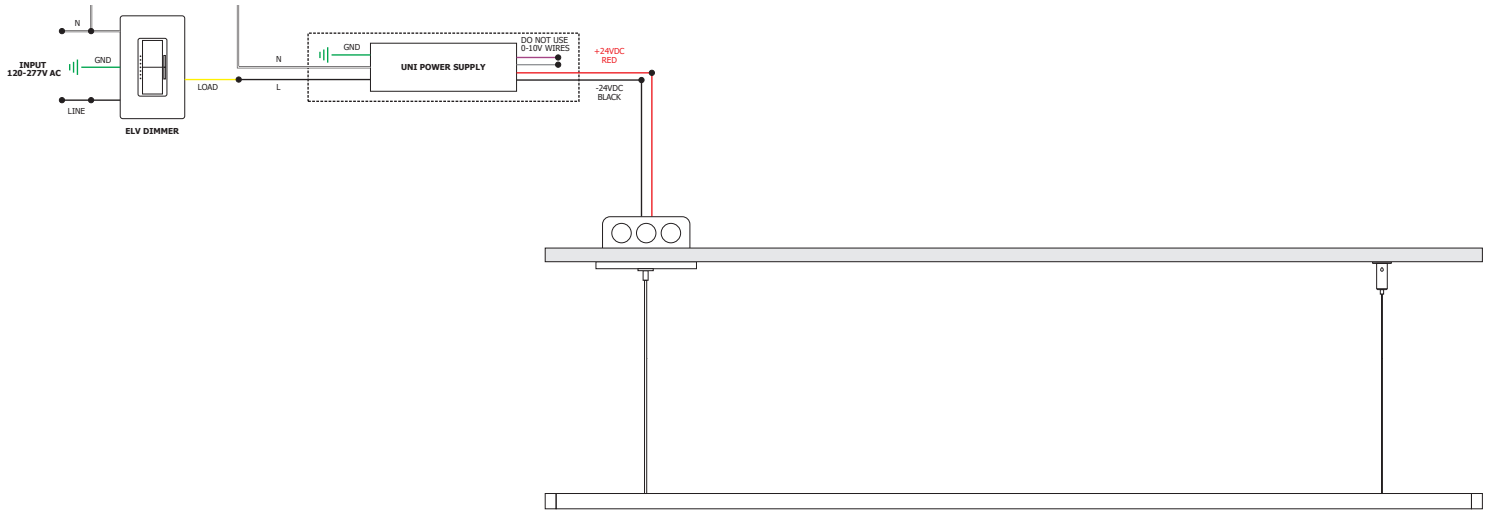

Wiring Diagram: Wiring diagram for Static White with 0-10 Volt Dimmer

- Application:** 0-10V dimming for Zipp Suspension Downlight, End Feed Canopy, Static White
- Remote Power Supplies:** UL Class 2, 24VDC output: 120/277 VAC input, PSB-60W-010-24VDC, PSB-100W-010-24VDC
- Dimming:** Dimmable with 0-10 dimmer: Philips: Sunrise SR1200ZTUNV; Lutron: Diva DVTV-WH, Nova-T NTSTV-DV-XX, Grafix Eye QS QSGRJ-XP, Radio RA2 RRD-1-ND; Leviton: LEV40050, IP710-LFZ; Legrand ADPD4FBL3P2W4

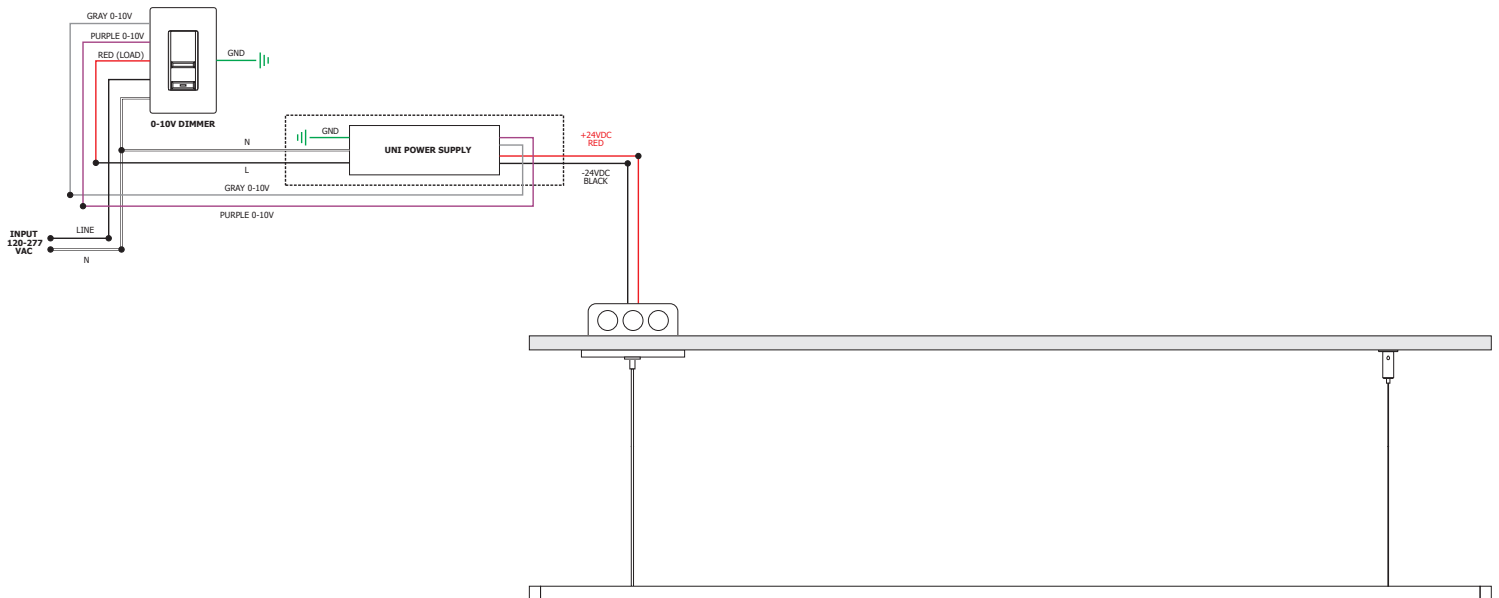

PROJECT		FIXTURE TYPE		DATE	
---------	--	--------------	--	------	--

ZIPP SUSPENSION

24VDC REMOTE POWER, STATIC WHITE & WARM DIM

Length Chart: Actual lengths for Zipp Suspension Downlight with Remote Power - End Feed

STATIC WHITE								
ORDERING CODE (NOMINAL SIZE)	ACTUAL LENGTH (INCHES)	ACTUAL LENGTH (CHROME)	ORDERING CODE (NOMINAL SIZE)	ACTUAL LENGTH (INCHES)	ACTUAL LENGTH (CHROME)	ORDERING CODE (NOMINAL SIZE)	ACTUAL LENGTH (INCHES)	ACTUAL LENGTH (CHROME)
12	13.1	13.1	171	171.9	172.3	329	330.7	331.1
15	15.5	15.5	173	174.3	174.7	332	333.1	333.5
17	17.9	17.9	176	176.7	177.1	334	335.5	335.9
20	20.3	20.3	178	179.1	179.5	336	337.9	338.3
22	22.7	22.7	180	181.5	181.9	339	340.3	341.1
24	25.1	25.1	183	183.9	184.3	341	342.7	343.5
27	27.5	27.5	185	186.3	186.7	344	345.0	345.9
29	29.9	29.9	188	188.7	189.1	346	347.4	348.3
32	32.3	32.3	190	191.1	191.5	348	349.8	350.7
34	34.7	34.7	192	193.5	193.9	351	352.2	353.0
36	37.1	37.1	195	195.9	196.3	353	354.6	355.4
39	39.5	39.5	197	198.3	198.7	356	357.0	357.8
41	41.9	41.9	200	200.7	201.1	358	359.4	360.2
44	44.3	44.3	202	203.1	203.5	360	361.8	362.6
46	46.7	46.7	204	205.5	205.9	363	364.6	365.0
48	49.1	49.1	207	207.9	208.3	365	367.0	367.4
51	51.5	51.5	209	210.3	210.7	368	369.4	369.8
53	53.9	53.9	212	212.7	213.1	370	371.8	372.2
56	56.3	56.3	214	215.1	215.5	372	374.2	374.6
58	58.7	58.7	216	217.5	217.9	375	376.6	377.0
60	61.1	61.1	219	219.9	220.3	377	379.0	379.4
63	63.5	63.5	221	222.3	222.7	380	381.4	381.8
65	65.9	65.9	224	224.7	225.1	382	383.8	384.2
68	68.3	68.3	226	227.1	227.5	384	386.2	386.6
70	70.7	70.7	228	229.5	229.9	387	388.6	389.0
72	73.1	73.1	231	231.9	232.3	389	391.0	391.4
75	75.5	75.5	233	234.3	234.7	392	393.4	393.8
77	77.9	77.9	236	236.7	237.1	394	395.8	396.2
80	80.3	80.3	238	239.1	239.5	396	398.2	398.6
82	82.7	82.7	240	241.5	241.9	399	400.6	401.0
84	85.1	85.1	243	244.3	244.3	401	403.0	403.4
87	87.5	87.9	245	246.7	246.7	404	405.4	405.8
89	89.9	90.3	248	249.1	249.1	406	407.8	408.2
92	92.3	92.7	250	251.5	251.5	408	410.2	410.6
94	94.7	95.1	252	253.9	253.9	411	412.6	413.0
96	97.1	97.5	255	256.3	256.7	413	415.0	415.4
99	99.5	99.9	257	258.7	259.1	416	417.4	417.8
101	101.9	102.3	260	261.1	261.5	418	419.8	420.2
104	104.3	104.7	262	263.5	263.9	420	422.2	422.6
106	106.7	107.1	264	265.9	266.3	423	424.6	425.4
108	109.1	109.5	267	268.3	268.7	425	427.0	427.8
111	111.5	111.9	269	270.7	271.1	428	429.4	430.2
113	113.9	114.3	272	273.1	273.5	430	431.8	432.6
116	116.3	116.7	274	275.5	275.9	432	434.2	435.0
118	118.7	119.1	276	277.9	278.3	435	436.6	437.4
120	121.1	121.5	279	280.3	280.7	437	439.0	439.8
123	123.9	123.9	281	282.7	283.1	440	441.4	442.2
125	126.3	126.3	284	285.1	285.5	442	443.8	444.6
128	128.7	128.7	286	287.5	287.9	444	446.2	447.0
130	131.1	131.1	288	289.9	290.3	447	448.6	449.4
132	133.5	133.5	291	292.3	292.7	449	451.0	451.8
135	135.9	135.9	293	294.7	295.1	452	453.4	454.2
137	138.3	138.3	296	297.1	297.5	454	455.8	456.6
140	140.7	140.7	298	299.5	299.9	456	458.2	459.0
142	143.1	143.1	300	301.9	302.3	459	460.6	461.4
144	145.5	145.5	303	304.3	304.7	461	463.0	463.8
147	147.9	147.9	305	306.7	307.1	464	465.4	466.2
149	150.3	150.3	308	309.1	309.5	466	467.8	468.6
152	152.7	152.7	310	311.5	311.9	468	470.2	471.0
154	155.1	155.1	312	313.9	314.3	471	472.6	473.4
156	157.5	157.5	315	316.3	316.7	473	475.0	475.8
159	159.9	159.9	317	318.7	319.1	476	477.4	478.2
161	162.3	162.3	320	321.1	321.5	478	479.8	480.6
164	164.7	164.7	322	323.5	323.9	480	482.2	483.0
166	167.1	167.1	324	325.9	326.3			
168	169.5	169.5	327	328.3	328.7			

PROJECT		FIXTURE TYPE		DATE	
---------	--	--------------	--	------	--

Length Chart: Actual lengths for Zipp Suspension Downlight with Remote Power - End Feed
WARM DIM 27D & 30D (5W)

ORDERING CODE (NOMINAL SIZE)	ACTUAL LENGTH (INCHES)	ACTUAL LENGTH (CHROME)	ORDERING CODE (NOMINAL SIZE)	ACTUAL LENGTH (INCHES)	ACTUAL LENGTH (CHROME)	ORDERING CODE (NOMINAL SIZE)	ACTUAL LENGTH (INCHES)	ACTUAL LENGTH (CHROME)
12	13.1	13.1	171	172.5	172.9	330	331.5	332.3
15	16.1	16.1	174	175.5	175.9	333	334.5	335.3
18	19.1	19.1	177	178.5	178.9	336	337.5	338.3
21	22.1	22.1	180	181.5	181.9	339	340.5	341.7
24	25.1	25.1	183	184.5	184.9	342	343.5	344.7
27	28.1	28.1	186	187.5	187.9	345	346.5	347.7
30	31.1	31.1	189	190.5	190.9	348	349.5	350.7
33	34.1	34.1	192	193.5	193.9	351	352.5	353.7
36	37.1	37.1	195	196.5	196.9	354	355.5	356.7
39	40.1	40.1	198	199.5	199.9	357	358.5	359.7
42	43.1	43.1	201	202.5	202.9	360	361.5	362.7
45	46.1	46.1	204	205.5	205.9	363	364.9	365.7
48	49.1	49.1	207	208.5	208.9	366	367.9	368.7
51	52.1	52.1	210	211.5	211.9	369	370.9	371.7
54	55.1	55.1	213	214.5	214.9	372	373.9	374.7
57	58.1	58.1	216	217.5	217.9	375	376.9	377.7
60	61.1	61.1	219	220.5	220.9	378	379.9	380.7
63	64.1	64.1	222	223.5	223.9	381	382.9	383.7
66	67.1	67.1	225	226.5	226.9	384	385.9	386.7
69	70.1	70.1	228	229.5	229.9	387	388.9	389.7
72	73.1	73.1	231	232.5	232.9	390	391.9	392.7
75	76.1	76.1	234	235.5	235.9	393	394.9	395.7
78	79.1	79.1	237	238.5	238.9	396	397.9	398.7
81	82.1	82.1	240	241.5	241.9	399	400.9	401.7
84	85.1	85.1	243	244.5	244.9	402	403.9	404.7
87	88.1	88.5	246	247.5	247.9	405	406.9	407.7
90	91.1	91.5	249	250.5	250.9	408	409.9	410.7
93	94.1	94.5	252	253.5	253.9	411	412.9	413.7
96	97.1	97.5	255	256.5	257.3	414	415.9	416.7
99	100.1	100.5	258	259.5	260.3	417	418.9	419.7
102	103.1	103.5	261	262.5	263.3	420	421.9	422.7
105	106.1	106.5	264	265.5	266.3			
108	109.1	109.5	267	268.5	269.3			
111	112.1	112.5	270	271.5	272.3			
114	115.1	115.5	273	274.5	275.3			
117	118.1	118.5	276	277.5	278.3			
120	121.1	121.5	279	280.5	281.3			
123	124.5	124.5	282	283.5	284.3			
126	127.5	127.5	285	286.5	287.3			
129	130.5	130.5	288	289.5	290.3			
132	133.5	133.5	291	292.5	293.3			
135	136.5	136.5	294	295.5	296.3			
138	139.5	139.5	297	298.5	299.3			
141	142.5	142.5	300	301.5	302.3			
144	145.5	145.5	303	304.5	305.3			
147	148.5	148.5	306	307.5	308.3			
150	151.5	151.5	309	310.5	311.3			
153	154.5	154.5	312	313.5	314.3			
156	157.5	157.5	315	316.5	317.3			
159	160.5	160.5	318	319.5	320.3			
162	163.5	163.5	321	322.5	323.3			
165	166.5	166.5	324	325.5	326.3			
168	169.5	169.5	327	328.5	329.3			

PROJECT		FIXTURE TYPE		DATE	
---------	--	--------------	--	------	--

TM30 DATA

DOWNLIGHT WITH REMOTE POWER, END FEED

TM-30-15 DATA: The data below is for SS2C, SS5C, SS7C, and SS10C bare LED Soft Strips. Consistent color temperatures throughout a single strip and among multiple strips is possible through a 3 phase binning process in which each order is inspected with a color meter to ensure uniformity

2400K | Rf: 91.2 | Rg: 96.8

Color Vector Graphic

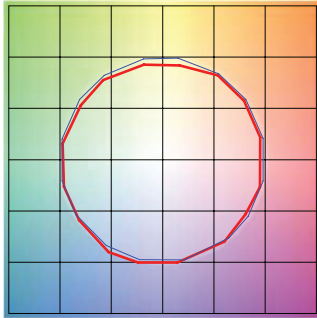

■ Test ■ Reference

HUE BIN	Rf	GRAPHIC SHIFTS %	
		CHROMA	HUE
1	92.0	-2.4%	1.5%
2	94.7	-2.1%	0.0%
3	95.4	-1.9%	-0.1%
4	88.7	-6.7%	-3.1%
5	92.8	-5.6%	1.0%
6	92.7	-3.4%	3.4%
7	89.9	-4.3%	4.1%
8	92.4	-1.4%	4.4%
9	89.0	-0.6%	5.8%
10	88.9	0.4%	6.2%
11	89.7	4.0%	5.4%
12	92.6	3.0%	-0.7%
13	90.9	1.1%	-7.0%
14	89.9	0.5%	-5.8%
15	92.1	-3.2%	0.1%
16	88.9	-1.7%	-6.3%

2700K | Rf: 87.7 | Rg: 96.1

Color Vector Graphic

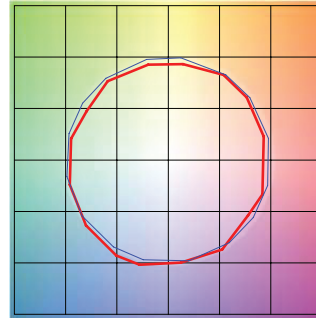

■ Test ■ Reference

HUE BIN	Rf	GRAPHIC SHIFTS %	
		CHROMA	HUE
1	88.0	-4.3%	2.6%
2	91.6	-2.4%	2.0%
3	93.7	-1.4%	1.9%
4	88.9	-5.6%	-3.1%
5	92.3	-5.5%	-0.5%
6	92.9	-3.5%	0.1%
7	84.5	-7.5%	4.6%
8	90.8	-3.0%	4.4%
9	84.5	-1.3%	8.3%
10	83.9	2.0%	9.8%
11	87.2	5.3%	7.1%
12	89.2	5.4%	-2.6%
13	88.7	0.3%	-7.8%
14	86.8	1.7%	-9.3%
15	87.6	-5.4%	-1.3%
16	83.6	-3.3%	-9.5%

3000K | Rf: 88.1 | Rg: 99.7

Color Vector Graphic

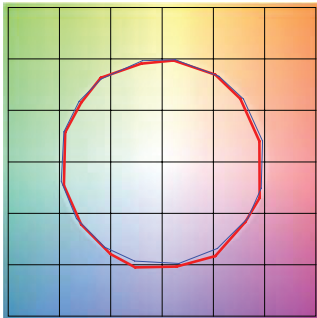

■ Test ■ Reference

HUE BIN	Rf	GRAPHIC SHIFTS %	
		CHROMA	HUE
1	92.5	-3.1%	0.3%
2	93.3	-2.3%	1.9%
3	90.9	-0.8%	3.9%
4	94.3	-1.1%	1.4%
5	92.5	-2.6%	1.5%
6	96.4	1.2%	-0.3%
7	92.6	-2.5%	-0.0%
8	96.9	-1.4%	0.2%
9	92.3	-1.8%	4.3%
10	86.6	-0.7%	7.0%
11	86.5	2.4%	8.2%
12	89.8	5.9%	1.7%
13	93.9	2.6%	-2.7%
14	89.4	5.1%	-5.8%
15	90.1	-0.1%	-4.7%
16	86.5	0.3%	-9.7%

3500K | Rf: 86.1 | Rg: 95.5

Color Vector Graphic

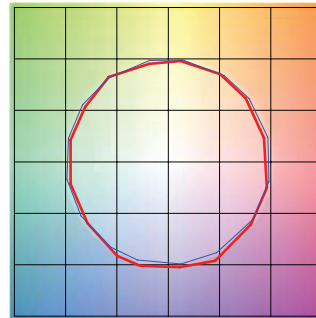

■ Test ■ Reference

HUE BIN	Rf	GRAPHIC SHIFTS %	
		CHROMA	HUE
1	90.8	-3.8%	0.3%
2	92.3	-2.8%	2.1%
3	89.7	-1.0%	4.3%
4	92.6	-1.4%	1.7%
5	91.8	-3.1%	1.3%
6	96.2	0.8%	-0.4%
7	92.9	-3.2%	0.2%
8	94.3	-2.5%	1.5%
9	90.4	-2.5%	5.2%
10	84.3	-1.4%	9.5%
11	83.1	3.5%	9.8%
12	88.2	4.8%	3.4%
13	94.0	2.7%	-2.0%
14	88.7	5.9%	-5.8%
15	88.7	0.7%	-5.9%
16	86.8	-0.7%	-6.7%

4000K | Rf: 87.6 | Rg: 96.8

Color Vector Graphic

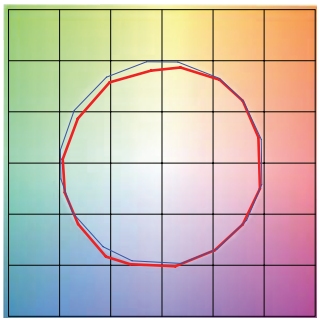

■ Test ■ Reference

HUE BIN	Rf	GRAPHIC SHIFTS %	
		CHROMA	HUE
1	88.9	-2.4%	2.5%
2	93.3	-0.4%	0.8%
3	94.8	-1.0%	-0.6%
4	87.9	-4.9%	-3.6%
5	85.3	-9.4%	-2.6%
6	90.2	-6.0%	0.2%
7	85.3	-7.6%	4.6%
8	83.7	-4.1%	8.2%
9	79.5	-1.1%	13.8%
10	78.6	1.5%	12.1%
11	83.5	6.4%	7.8%
12	90.9	3.6%	-1.1%
13	88.3	1.7%	-6.3%
14	91.9	-0.4%	-2.2%
15	84.5	-0.9%	-5.5%
16	84.7	-1.1%	-4.4%

PROJECT	FIXTURE TYPE	DATE
---------	--------------	------

TM30 DATA

DOWNLIGHT WITH REMOTE POWER, END FEED

TM-30-15 DATA: The data below is for SS2C, SS5C, SS7C, and SS10C bare LED Soft Strips. Consistent color temperatures throughout a single strip and among multiple strips is possible through a 3 phase binning process in which each order is inspected with a color meter to ensure uniformity

2700D | Rf: 89.5 | Rg: 100.8

Color Vector Graphic

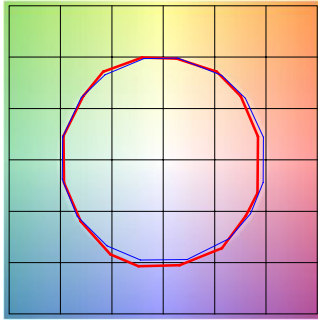

■ Test ■ Reference

HUE BIN	Rf	GRAPHIC SHIFTS %	
		CHROMA	HUE
1	88.8	-5.1%	1.4%
2	89.8	-2.7%	4.1%
3	87.2	0.3%	5.9%
4	92.3	-0.9%	1.0%
5	93.3	1.5%	1.7%
6	92.4	3.6%	-0.2%
7	92.2	-0.9%	-2.4%
8	96.7	-0.4%	-1.1%
9	92.3	-1.2%	3.7%
10	88.9	-0.0%	6.1%
11	86.4	5.1%	7.4%
12	88.2	6.3%	-0.9%
13	87.2	3.8%	-8.1%
14	84.2	3.8%	-11.0%
15	89.8	-2.6%	-4.3%
16	82.7	-3.4%	-11.1%

3000D | Rf: 89.8 | Rg: 101.4

Color Vector Graphic

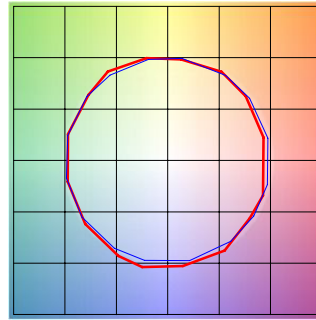

■ Test ■ Reference

HUE BIN	Rf	GRAPHIC SHIFTS %	
		CHROMA	HUE
1	90.2	-4.2%	1.5%
2	90.9	-2.0%	3.7%
3	87.9	0.8%	5.5%
4	92.1	-0.9%	0.6%
5	93.0	1.5%	1.6%
6	92.2	3.9%	-0.2%
7	92.1	-0.3%	-2.0%
8	96.7	0.0%	-1.2%
9	92.5	-0.6%	3.7%
10	88.3	1.1%	7.0%
11	87.2	4.1%	7.4%
12	87.2	6.7%	-1.0%
13	88.2	3.8%	-7.2%
14	85.3	4.3%	-9.9%
15	90.9	-2.2%	-3.6%
16	83.4	-2.2%	-11.2%

PROJECT		FIXTURE TYPE		DATE	
---------	--	--------------	--	------	--