

# TWO PARTS

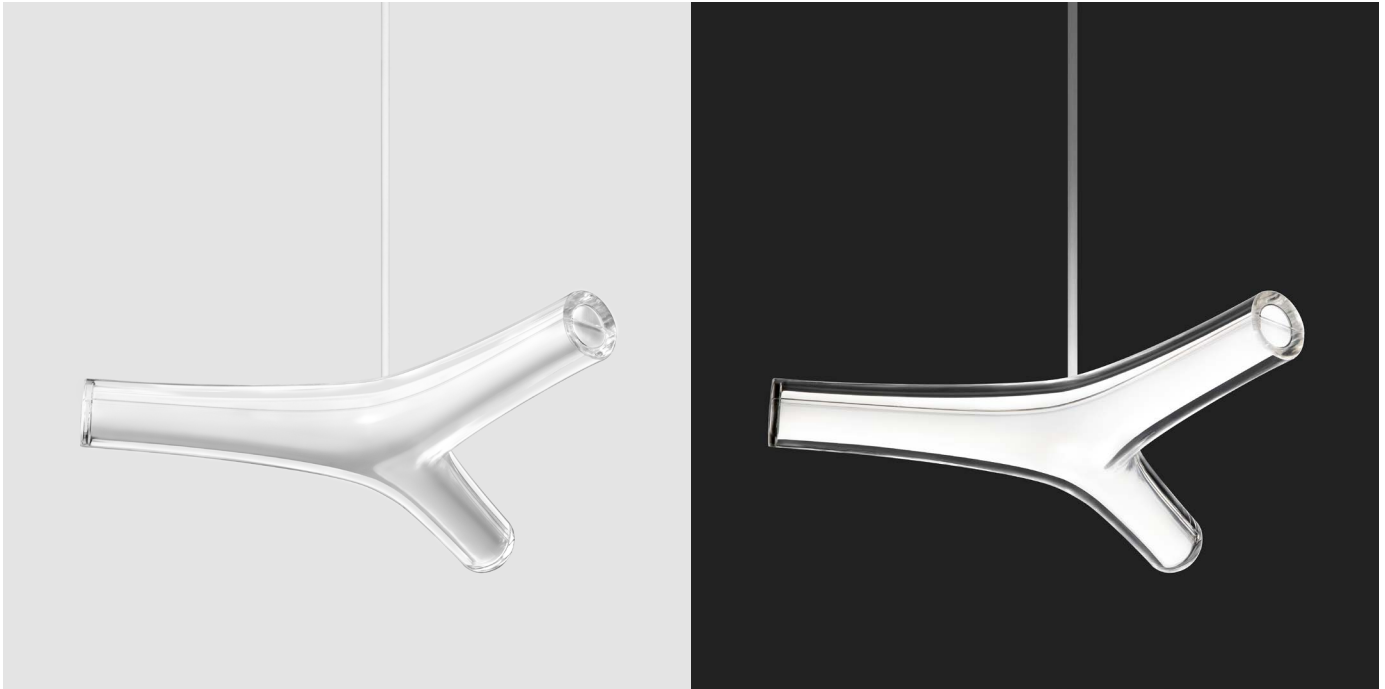

## Carbon

By Christo Logan

### Description

Indoor Pendant Fixture

### Fixture

Material: Acrylic + Polycarbonate  
Color: Clear + White  
Dims: 12.8 x 14.7 x 2.6 in  
Dims: 324 x 373 x 66 mm

### Cord

Color: White  
Length: 20 ft / 6 m

### Driver

Fits in most Junction Boxes  
Dimming: Triac, ELV, 0-10V  
Input Voltage: 100-305V AC

### LED

Input: 15W  
Output: 1000 lm  
User replaceable: No  
Life Expectancy: 50,000 hours  
Color Accuracy: CRI 95+, R9 90+  
Input: 12V Constant Voltage

### Warranty

Fixture: 5 years  
Driver: 3 years

### Certification

ETL Listed (UL + CSA Standards)  
Damp Location  
CE, RoHS

### Download CAD, Revit, IES

<http://two.parts/carbon>

### Light Temp

- CAR-CW-27 : 2700K
- CAR-CW-30 : 3000K
- CAR-CW-35 : 3500K

### Cluster Size : Driver

- 1 : Two Parts 25W Driver
- 2 : Two Parts 40W Driver
- 3 : PWM-90-12 Driver
- 4 : PWM-90-12 Driver
- 5 : PWM-90-12 Driver
- 6 : PWM-90-12 Driver
- 7 : Any 110W+ 12V CV Driver

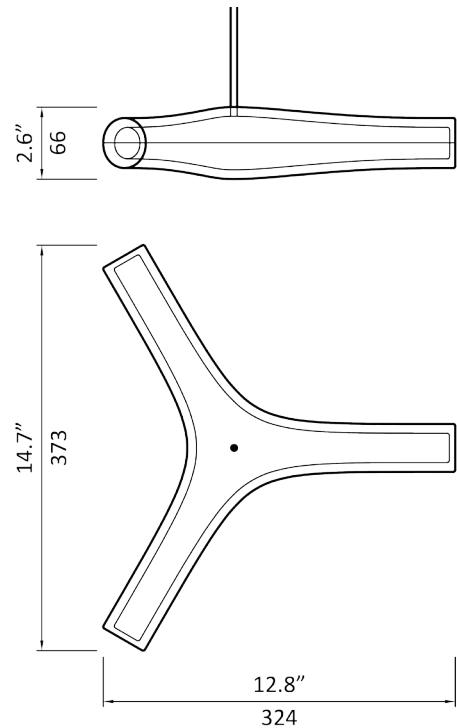

# TWO PARTS

Carbon Sample Layouts  
Download dwg at [two.parts/carbon](https://two.parts/carbon)

Jan 2023



# TWO PARTS

Carbon Sample Layouts  
Download dwg at [two.parts/carbon](http://two.parts/carbon)

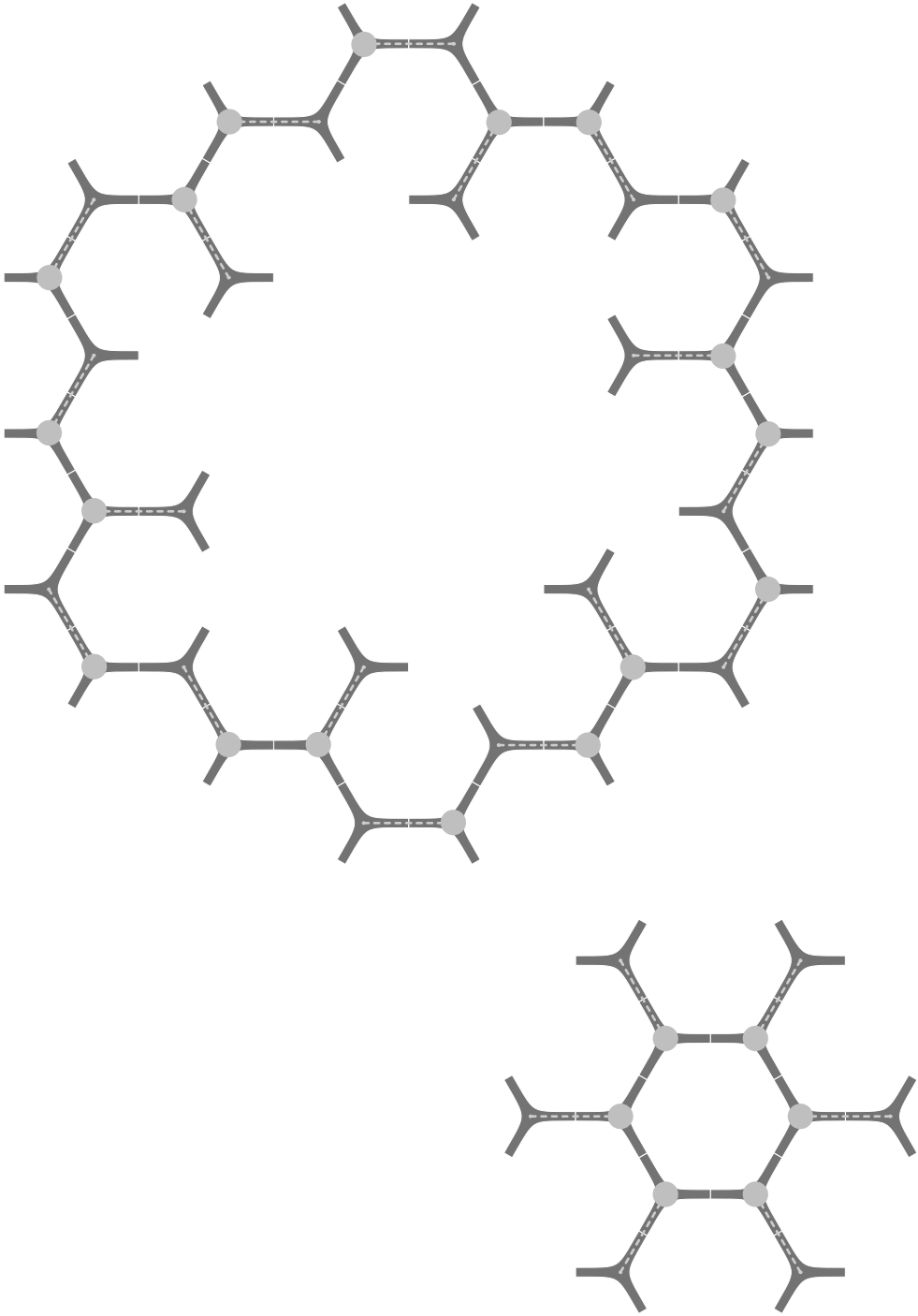

SCALE: 3/8" = 1'

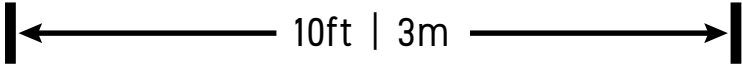

**2 Fixtures per Canopy** 40W Driver

# TWO PARTS

Carbon Sample Layouts  
Download dwg at [two.parts/carbon](http://two.parts/carbon)

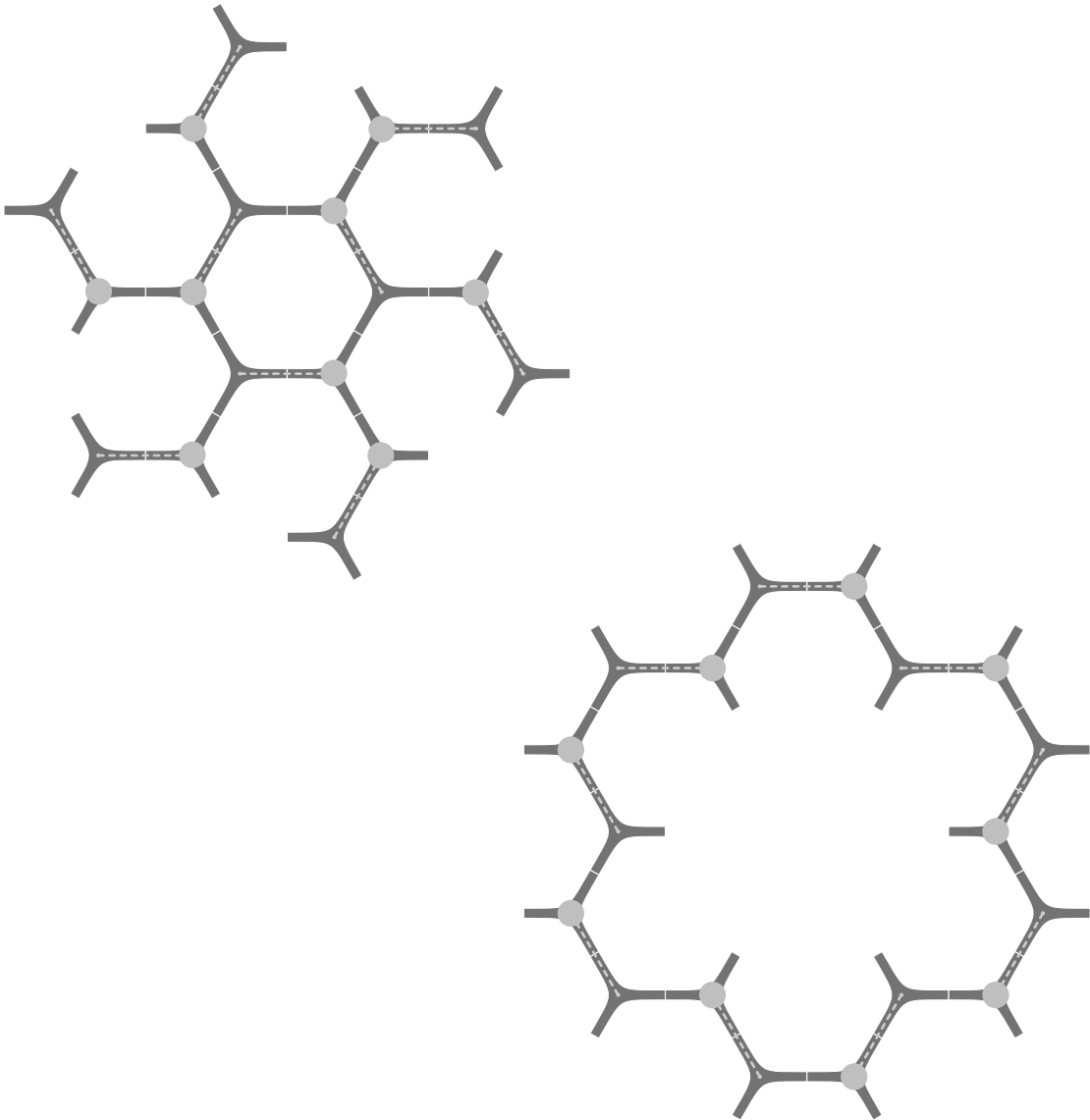

SCALE: 3/8" = 1'

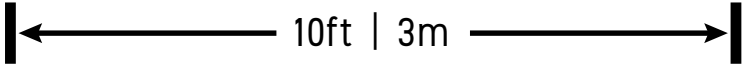

**2 Fixtures per Canopy** 40W Driver

# TWO PARTS

Carbon Sample Layouts  
Download dwg at [two.parts/carbon](http://two.parts/carbon)

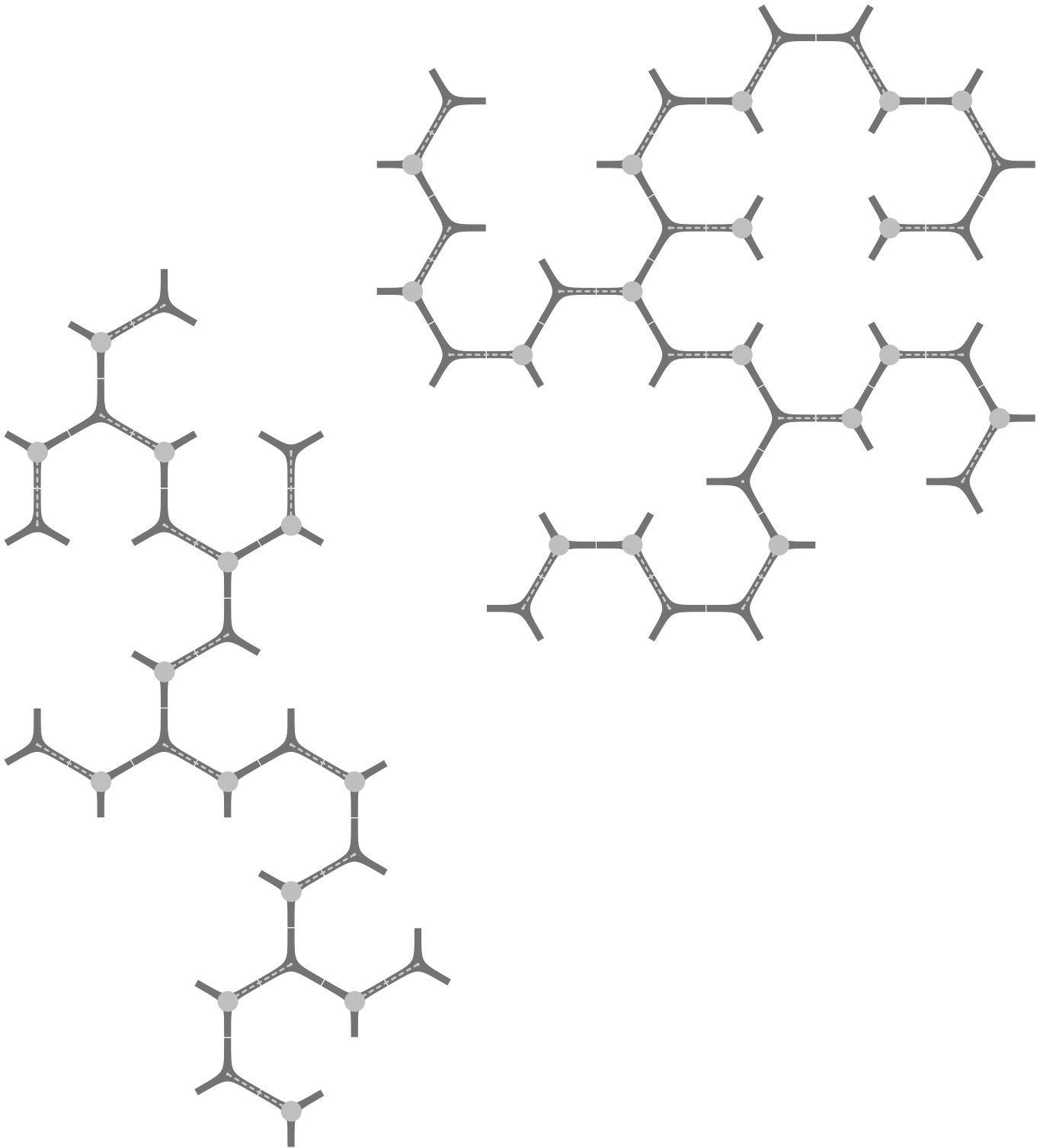

SCALE: 3/8" = 1'

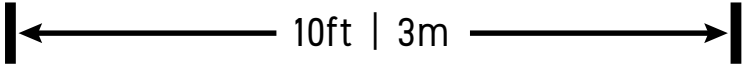

**2 Fixtures per Canopy** 40W Driver

# TWO PARTS

Carbon Sample Layouts  
Download dwg at [two.parts/carbon](http://two.parts/carbon)

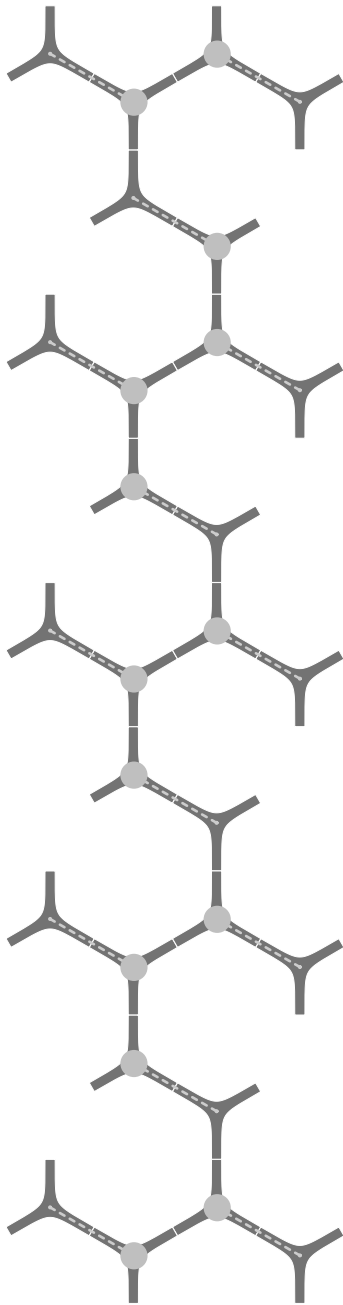
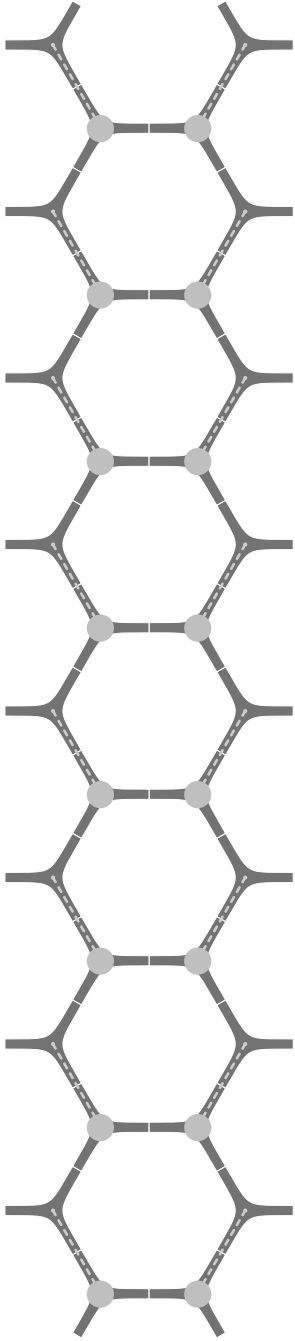
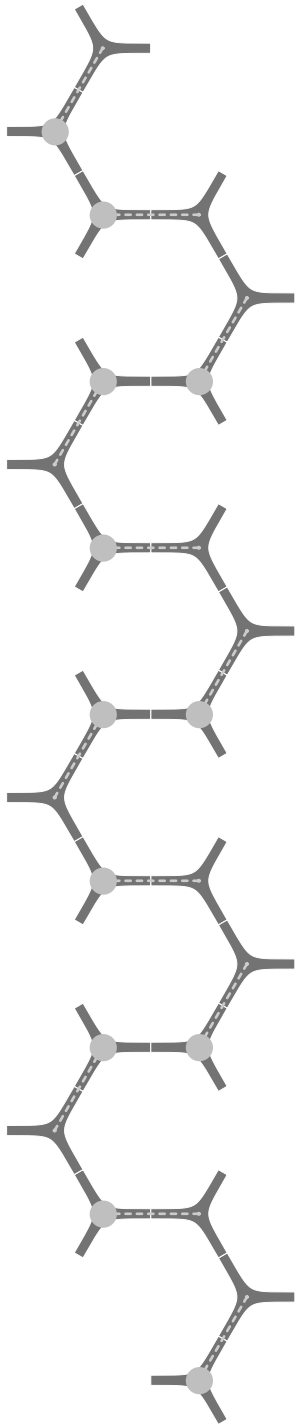

SCALE: 3/8" = 1'

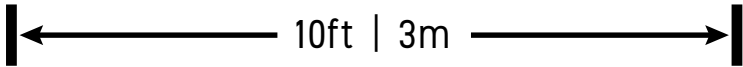

**2 Fixtures per Canopy** 40W Driver

# TWO PARTS

Carbon Sample Layouts  
Download dwg at [two.parts/carbon](http://two.parts/carbon)

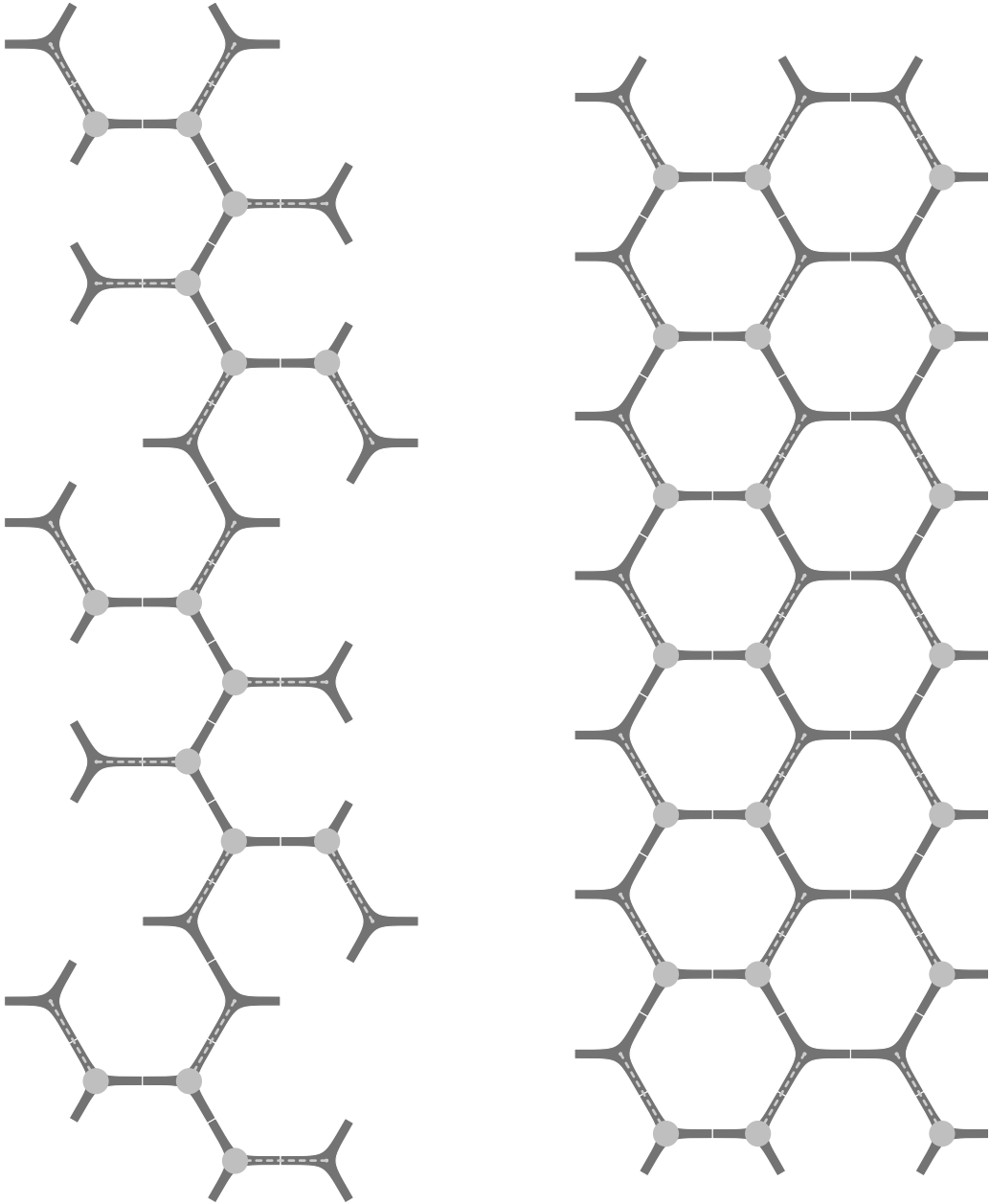

SCALE: 3/8" = 1'

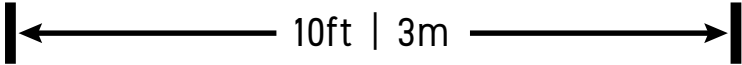

**2 Fixtures per Canopy** 40W Driver

# TWO PARTS

Carbon Sample Layouts  
Download dwg at [two.parts/carbon](http://two.parts/carbon)

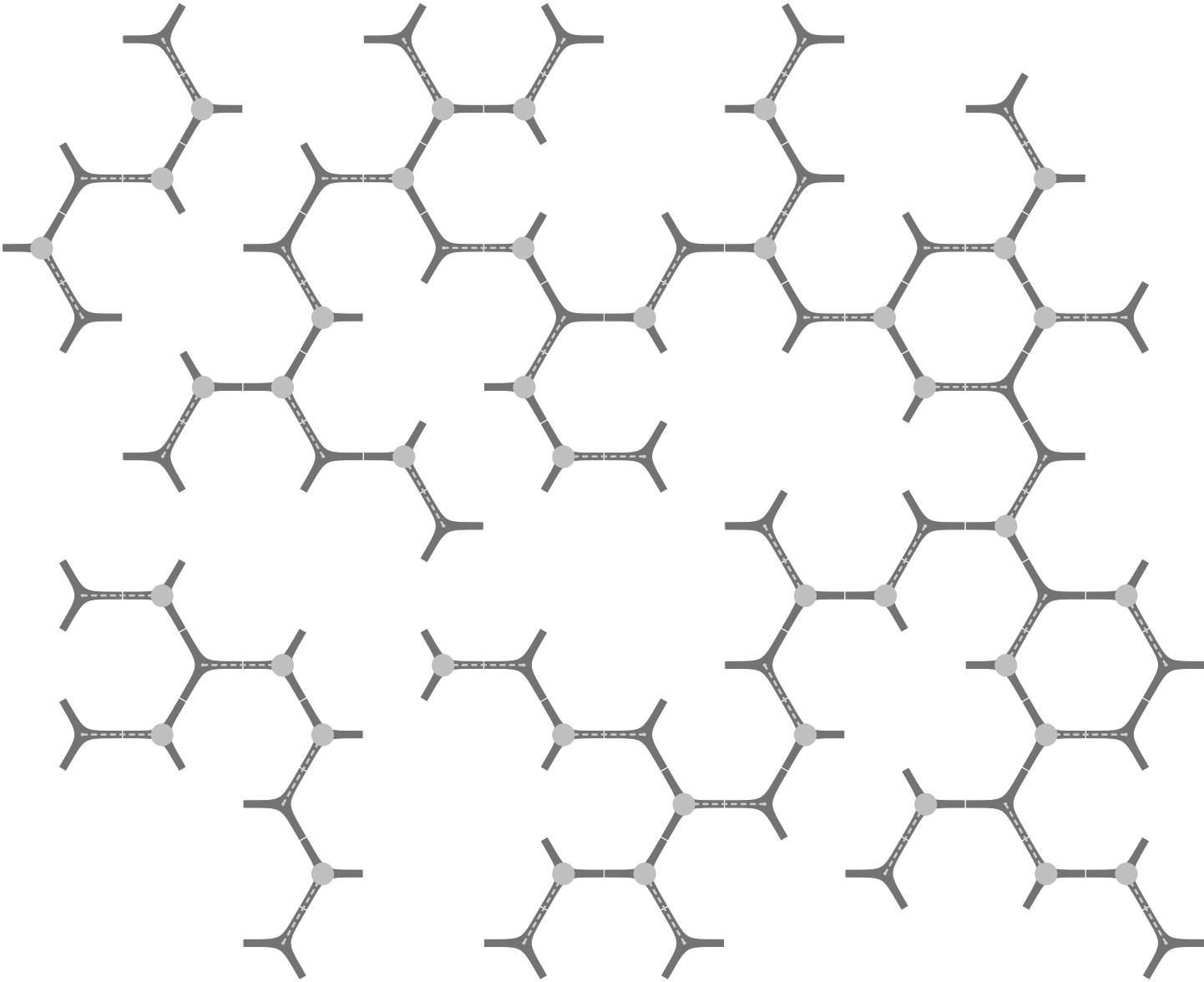

SCALE: 3/8" = 1'

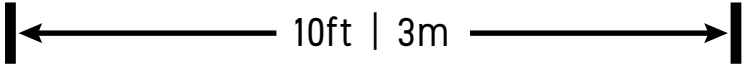

**2 Fixtures per Canopy** 40W Driver



# TWO PARTS

Carbon Sample Layouts  
Download dwg at [two.parts/carbon](http://two.parts/carbon)

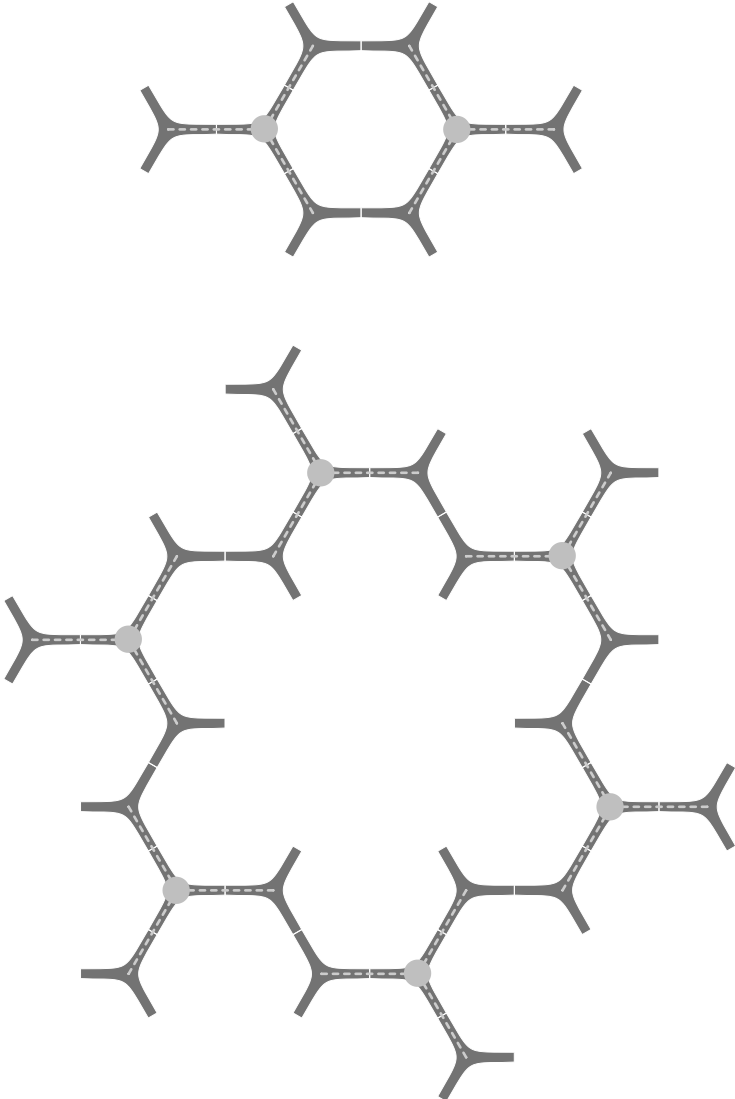

SCALE: 3/8" = 1'

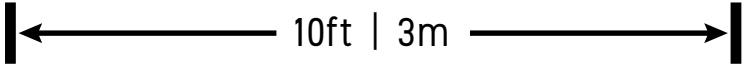

**4 Fixtures per Canopy** 90W Driver

# TWO PARTS

Carbon Sample Layouts  
Download dwg at [two.parts/carbon](http://two.parts/carbon)

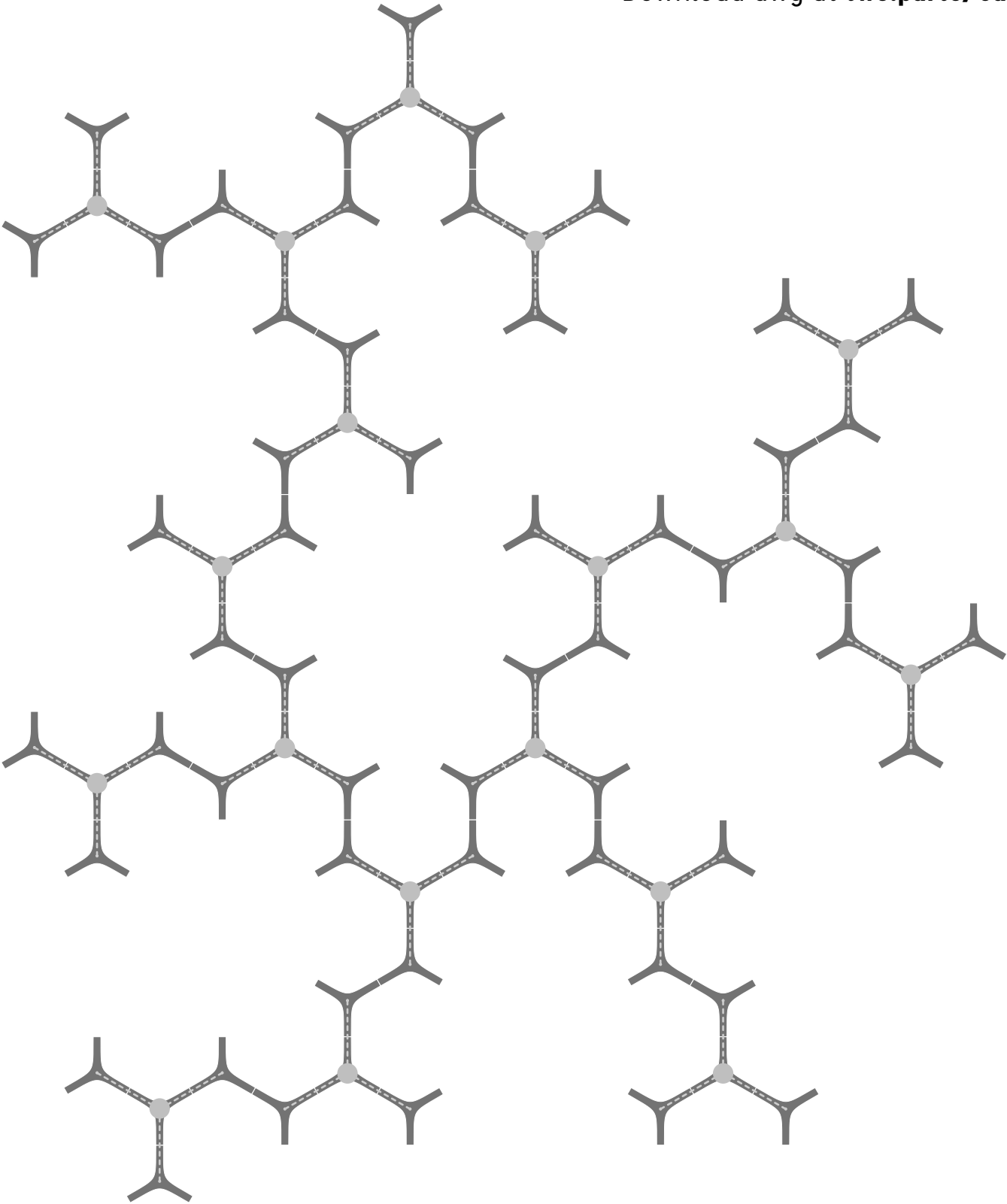

SCALE: 3/8" = 1'

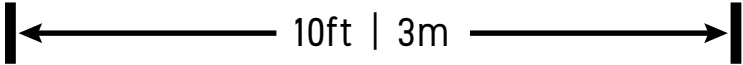

**4 Fixtures per Canopy** 90W Driver

# TWO PARTS

Carbon Sample Layouts  
Download dwg at [two.parts/carbon](http://two.parts/carbon)

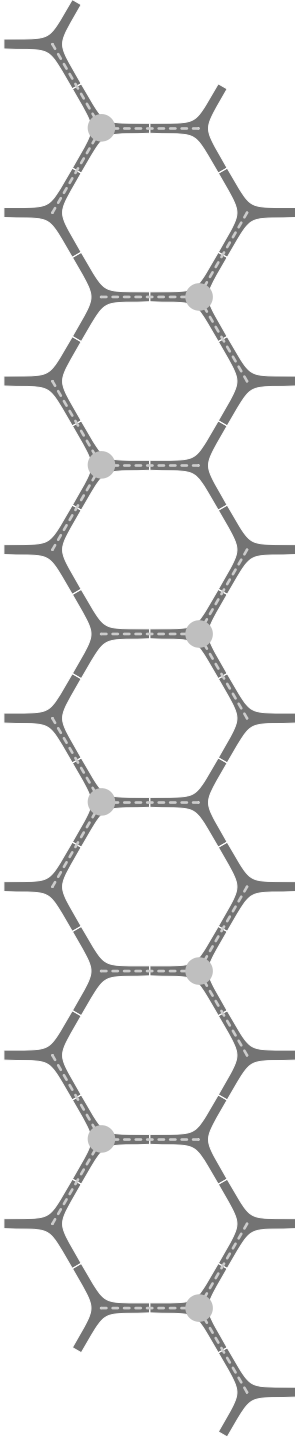
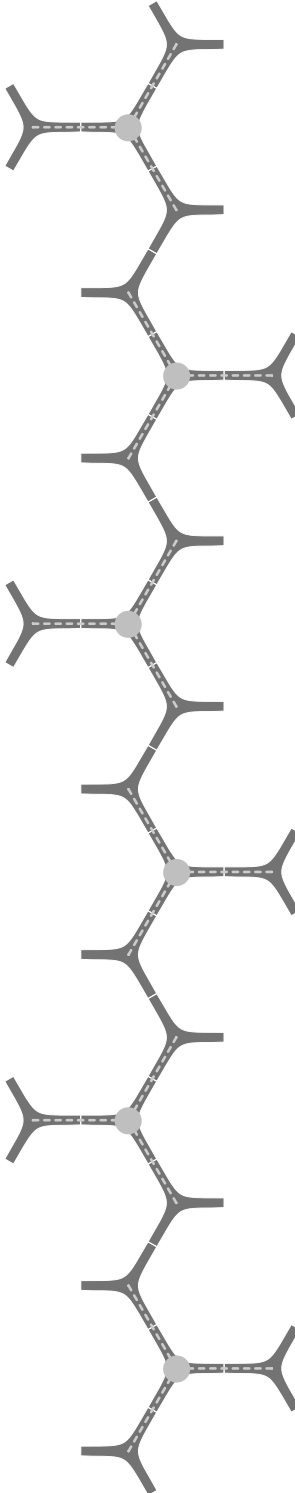
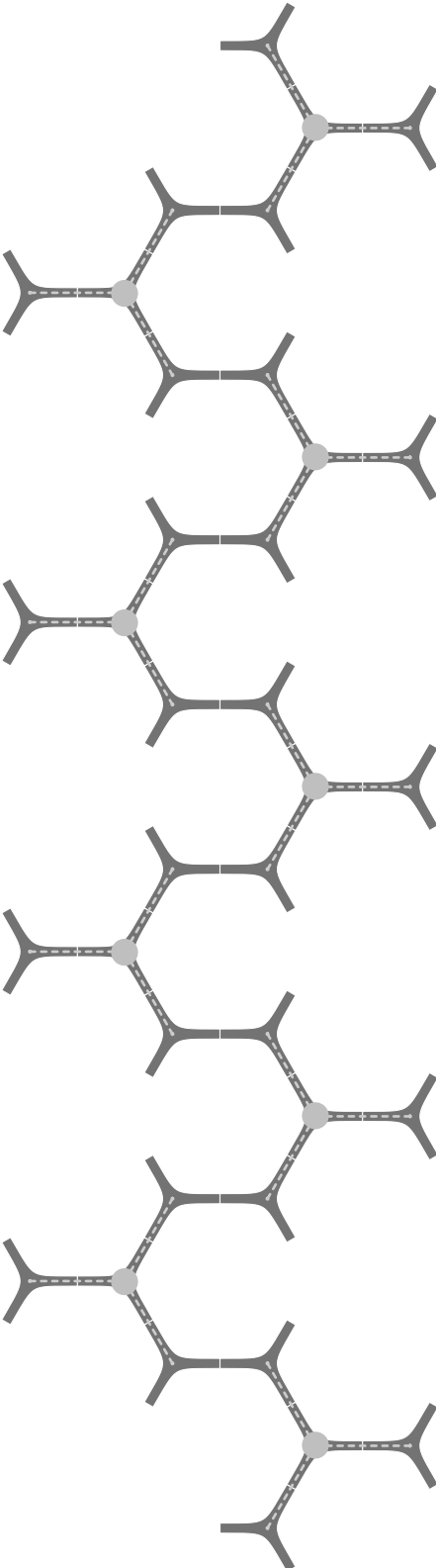

SCALE: 3/8" = 1'

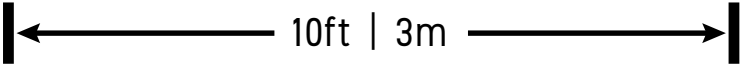

**4 Fixtures per Canopy** 90W Driver

# TWO PARTS

Carbon Sample Layouts  
Download dwg at [two.parts/carbon](http://two.parts/carbon)

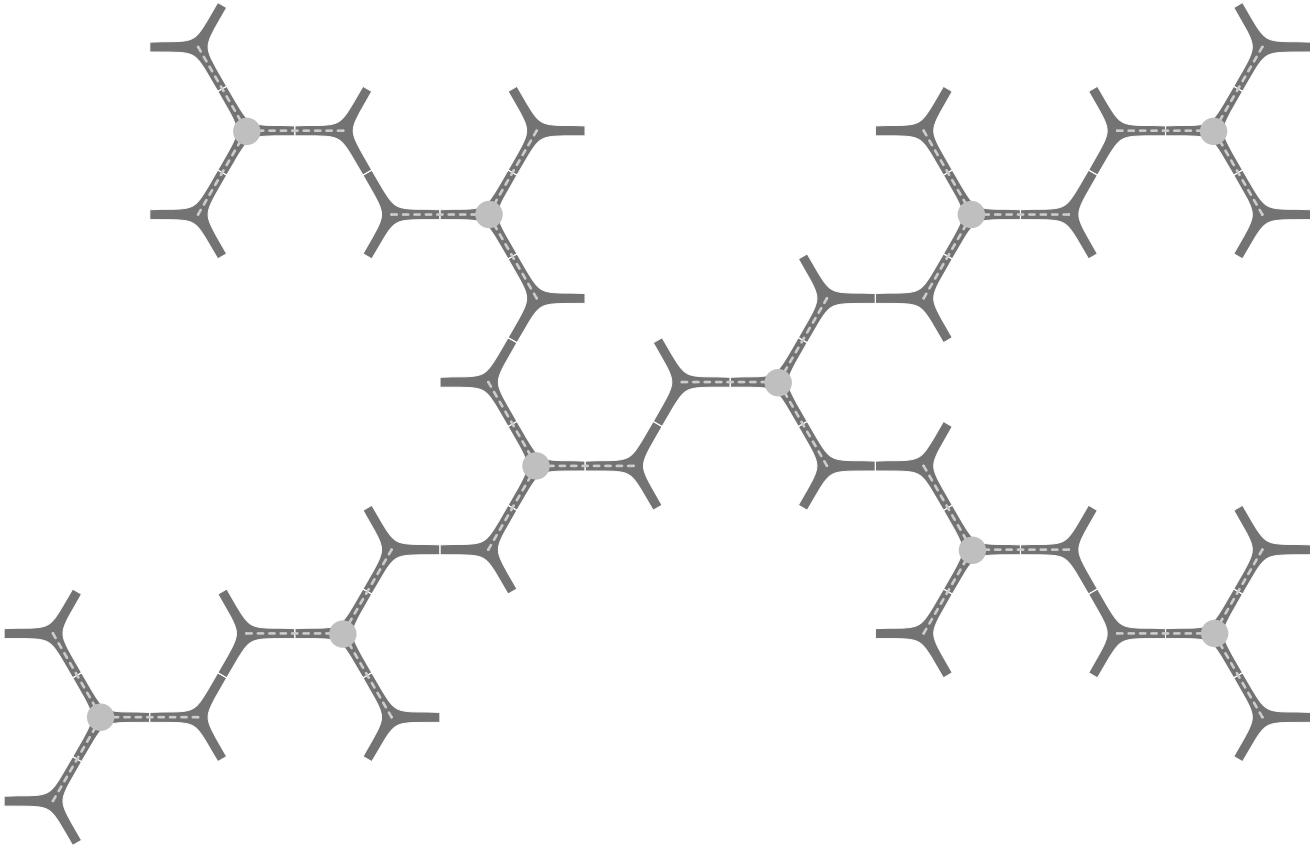
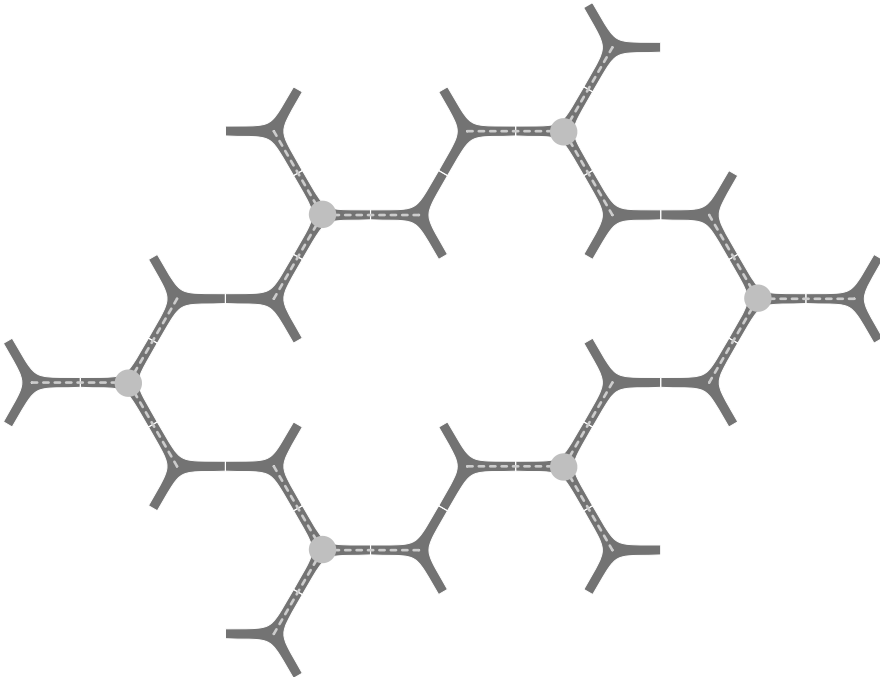

SCALE: 3/8" = 1'

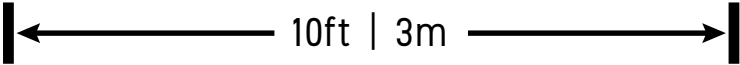

**4 Fixtures per Canopy** 90W Driver

# TWO PARTS

Carbon Sample Layouts  
Download dwg at [two.parts/carbon](http://two.parts/carbon)

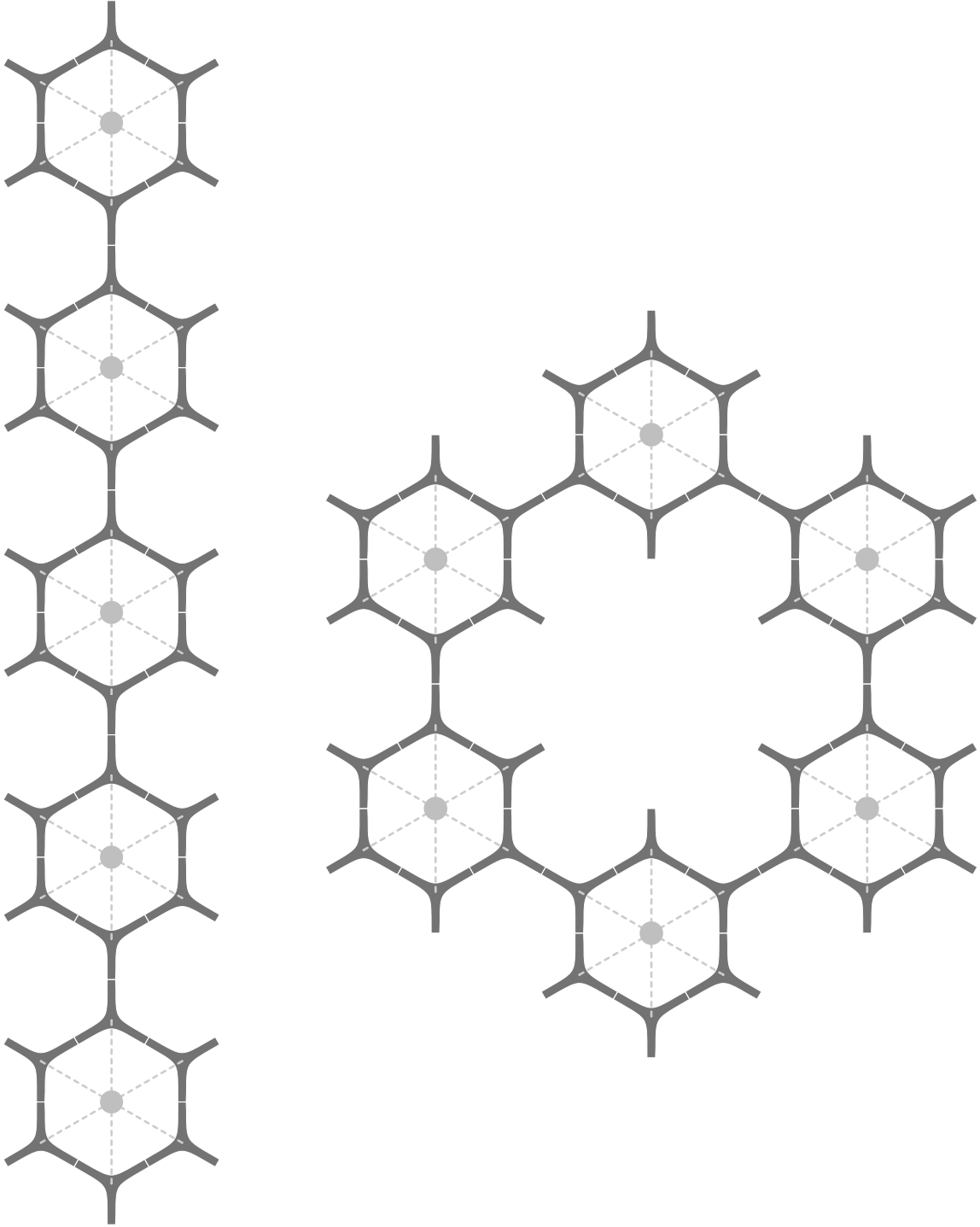

SCALE: 3/8" = 1'

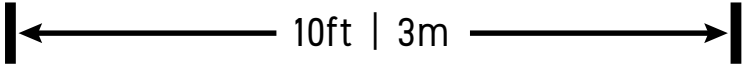

**6 Fixtures per Canopy** 90W Driver

# TWO PARTS

Carbon Sample Layouts  
Download dwg at [two.parts/carbon](http://two.parts/carbon)

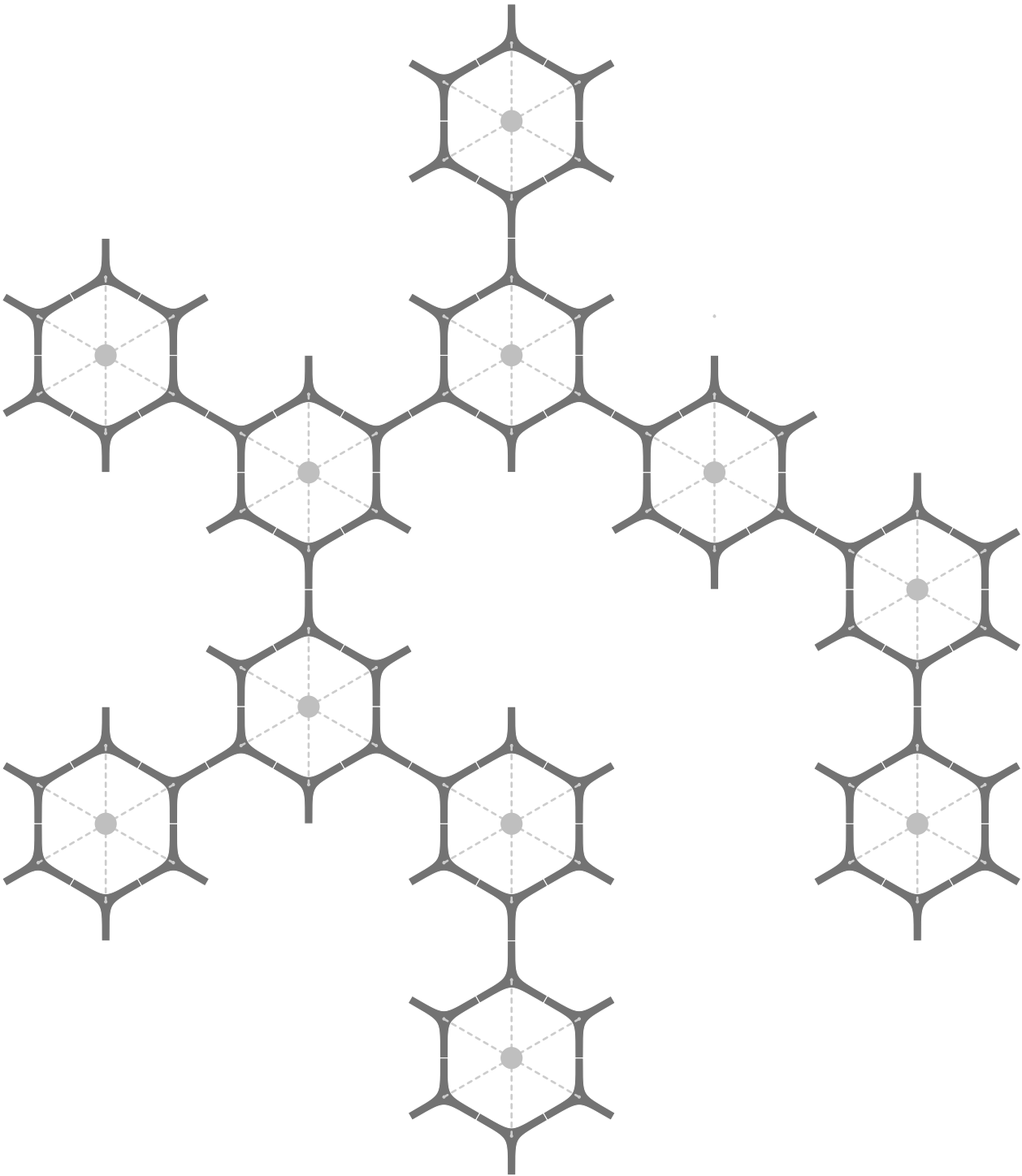

SCALE: 3/8" = 1'

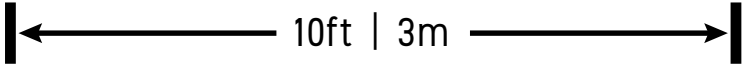

**6 Fixtures per Canopy** 90W Driver

# TWO PARTS

Carbon Sample Layouts  
Download dwg at [two.parts/carbon](http://two.parts/carbon)

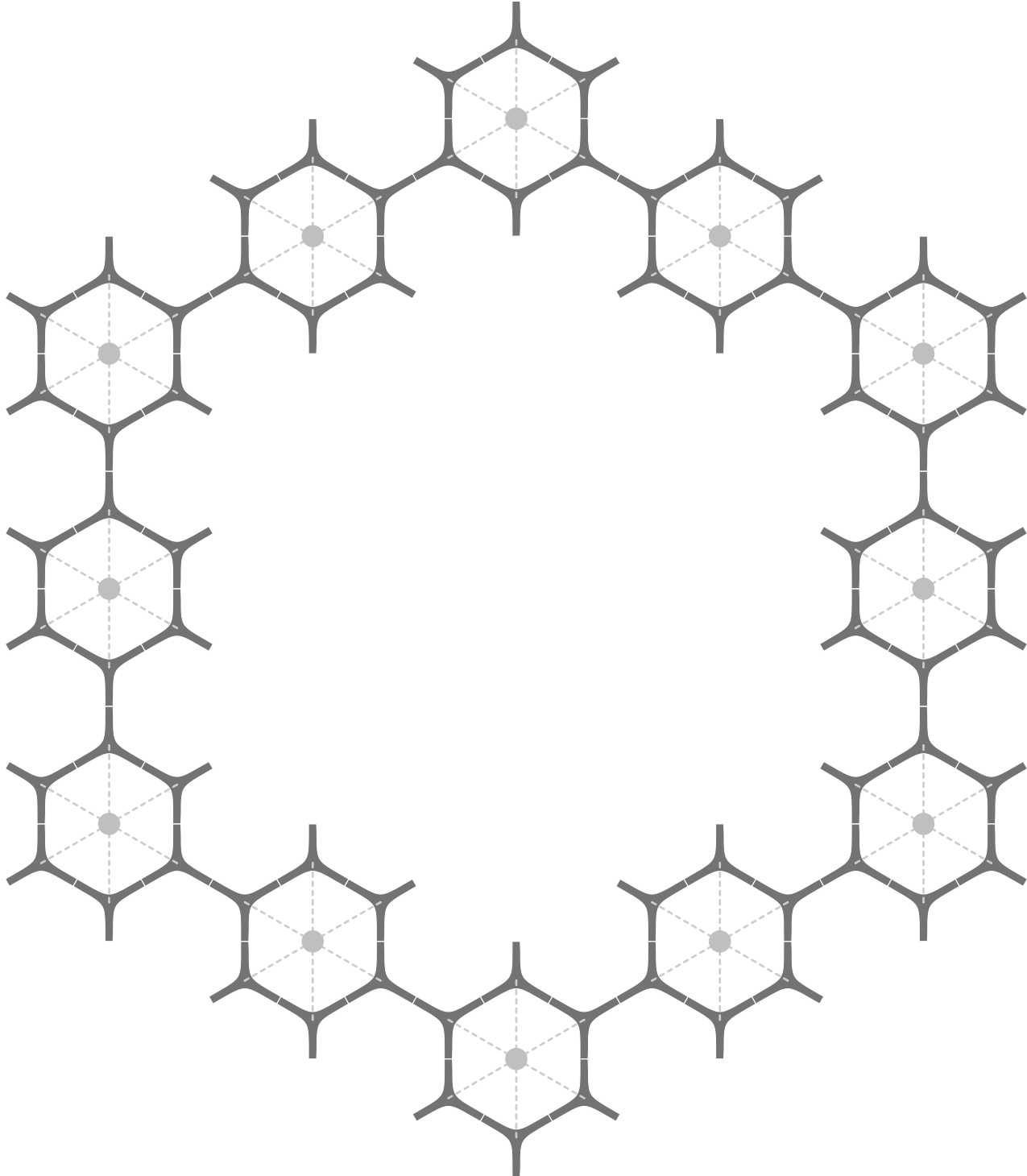

SCALE: 3/8" = 1'

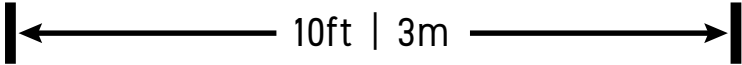

**6 Fixtures per Canopy** 90W Driver