

ASWV1532

Wave Style Switches

adorne® Wave Style Switches feature innovative technology combined with sleek, contemporary design. Simply wave your hand in front of the switch to turn lights on and off. With this touch-free motion, the Wave is ideal for countertop areas in kitchens and bathrooms. It has a preset sensor distance of approximately 4". However, this can easily be adjusted to sense movement from 1" to 6" in front of switch. Wave Switch includes a Locator Status Light which adds illumination and makes it easier to locate in the dark.



FEATURES & BENEFITS

adorne devices fit in all existing NEMA-approved wallboxes.

Heavy gauge steel frame is grounded via factory installed 12AWG ground lead. Device and metal wall plates are self-grounded to frame.

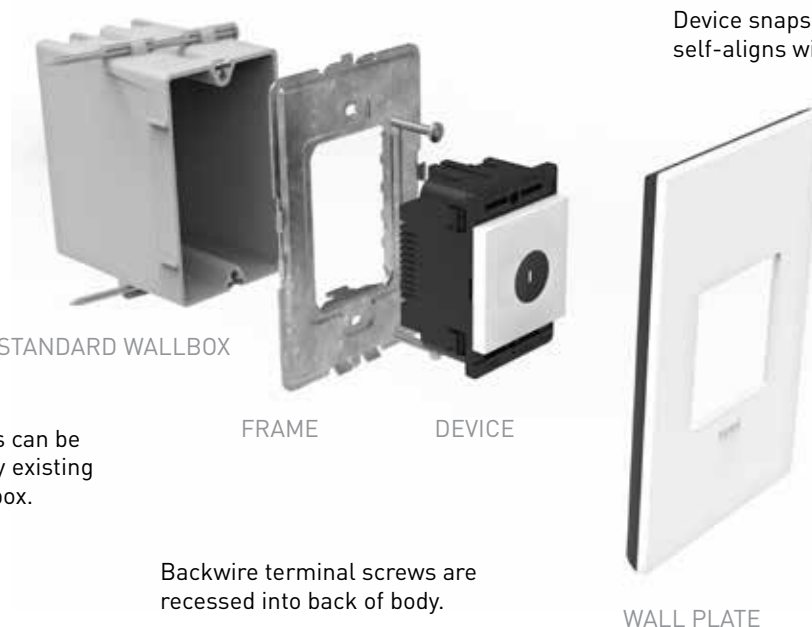

STANDARD WALLBOX

FRAME

DEVICE

WALL PLATE

adorne devices can be installed in any existing standard wallbox.

Backwire terminal screws are recessed into back of body.



Device snaps into the frame and self-aligns without any screws.

Wall plate snaps onto frame; no screws required.

Modular system solves device alignment problems, improving fit and finish in multi-gang installations.

Wall plate and frames available in 1-6 gang sizes.

ORDERING INFORMATION

CATALOG NUMBER	DESCRIPTION	RATING	COMPATIBLE LOADS	COMPLIANCE	COLORS	COO
ASWV1532M2	Single-Pole/3-Way	15A, 120VAC, 1/2Hp	All Loads		Magnesium	China
ASWV1532W2	Single-Pole/3-Way	15A, 120VAC, 1/2Hp	All Loads		White	China
ASWV1532G2	Single-Pole/3-Way	15A, 120VAC, 1/2Hp	All Loads		Graphite	China

COMPLEMENTARY PRODUCTS

adorne® also offers Paddle Style Dimmers and Fan Control Devices to pair with our Paddle Style Switches for an overall, aesthetically pleasing and multi-functional installation.

adorne® Wall Plates provide the perfect complement to adorne Switches, Dimmers, Outlets, and Accessories. The collection includes a variety of finishes, from metals to leather and wood, as well as plastic plates that are available in contemporary and classic colors.

Each wall plate is packaged with a metal frame to enable easy installation when paired with a device. All plates are screwless and simply snap onto the included metal frame.

All adorne wall plates are UL and ETL-approved.



2-Module
Paddle Dimmer



2-Module
Paddle Fan
Speed Control



1-Module
Paddle Switch

VERTICAL MARKETS

- Residential
- Hospitality
- Luxury Office
- Light Commercial

TECHNICAL SPECIFICATIONS

3rd Party Compliance

cULus Listed, File Number E350248, Standard UL508

Performance

ELECTRICAL

Maximum Working Voltage	120VAC
Ratings	15A Resistive, 15A General Purpose, 15A Incandescent, 1/2 HP 15A Standard Ballast, 15A Electronic Ballast

MECHANICAL

Terminal Accommodations	#14AWG-#12AWG
-------------------------	---------------

ENVIRONMENTAL

Flammability	UL94 V2
Operating Temperature	Maximum continuous +60°C, minimum -40°C without impact

Materials

Face	Polycarbonate	Terminal	Brass
Back Body	Polycarbonate	Termination	Steel Plated Scews
Contacts	Silver		

Warranty

Lifetime Limited Warranty

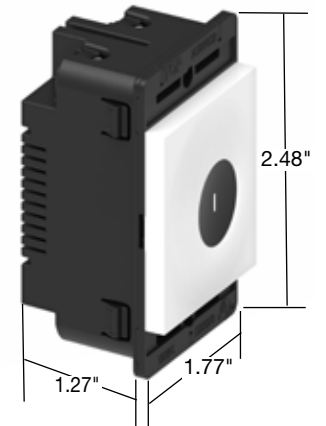
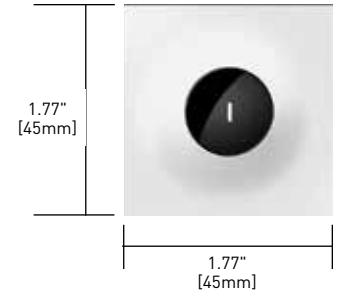

COMPLEMENTARY DEVICES & ACCESSORIES

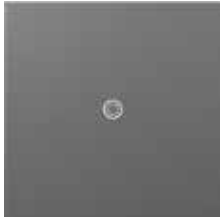

sofTap™

Switches & Dimmers – designed with an innovative micro-movement that turns lights on and off with just a soft “tap” of the finger.



SensaSwitch™

Switches & Dimmers – Sensor turns lights on when you enter a room and off when you leave. (Also available in Manual-ON/Auto-OFF format.)



Whisper™

Switches & Dimmers – A smart design that features elegant lines and a quiet, fluid motion.



Touch™

Switches & Dimmers – A stunning translucent face works just like an iPhone® – simply touch your finger on the circle to turn lights on and off.



Paddle™

Switches, Dimmers & Fan Speed Controls – A wide, graceful curve works with a simple up-and-down motion, allowing you to turn lights on and off with ease.



Wave™

Switches – Smart technology combined with sleek, modern design. Simply wave your hand to turn lights on and off.



Push™

Switches – A tactile, finger-sized impression lets you turn lights on and off with a simple push-button motion.

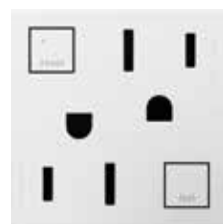

Tamper-Resistant Outlets/ Tamper-Resistant GFCI Outlets



USB Charging Outlets



Nightlight/Portable Nightlight Flashlight

PLUS: Compatible Wall Plates, Accent Lights, Locator Lights, Under-Cabinet Lighting System

NOTE: All brand and product names referenced in this document are registered trademarks or trademarks of their respective holders.



NOTE: The paper used to print this document is an environmentally responsible paper with 10% post consumer waste, with FSC and SFI Chain of Custody certifications, Lacey Act compliant. 100% of the electricity used to manufacture Flo sheets is generated with Green-e certified renewable energy.



Legrand, North America
60 Woodlawn Street
West Hartford, CT 06110
1.877.BY.LEGRAND (295.3472)
www.legrand.us

Canada
905.738.9195
www.legrand.ca

FOLLOW US





adorne Collection
adorne® 20A Wave® Switch, Magnesium, with Microban®
 Part No. ASWW2032M2

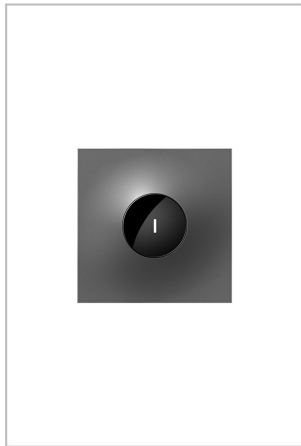

Perfect for turning the lights on or off when your hands are full or messy, especially in entryways or next to the kitchen sink. The 20A Wave Switch features innovative touchless technology that allows you to control lights with a wave of your hand, for a germ- and worry-free option that also adds contemporary style to any space. Use on its own to control a light or fixture from a single location, or pair with a second switch or dimmer to control a single light source from two locations.

This switch* features enduring Microban® antimicrobial technology that works to reduce the growth of bacteria, around the clock, for the lifespan of the product.

* Existing inventory of switches, dimmers and plastic wall plates from the adorne® Collection at some partner locations may not yet include Microban® protection. To confirm that a specific Legrand product is protected with Microban®, check that the exterior of the product packaging includes a green dot or a "Protected with Microban" label.

Made exclusively for use with screwless Wall Plates from the adorne® Collection, sold separately.

No antimicrobial efficacy claims are being made or are valid with respect to products sold in Canada.

Features & Benefits

Helps fight the growth of stain and odor-causing bacteria through the invisible and continuous product protection of Microban® antimicrobial technology

For complete installation, device must be paired with an adorne® screwless Wall Plate (not included). Available in a range of contemporary colors and stunning finishes.

Features innovative touchless control for a convenient, germ-free way to turn on lights...all it takes is a simple wave

Installs easily in 15 minutes or less, fitting into an existing electrical box. Usable in both single-pole and 3-way applications

Made for use in both residential and commercial applications; features durable construction to withstand rigorous cleaning practices

Includes a rating of up to 3/4 HP for adding touchless control to small motors

Adjust the internal sensor to respond to movement from 1"-6" from the switch face to fit your space and needs

More color options available to fit any style, including finishes to match current hardware and lighting trends

Specifications

General Info

Product Line	Pass & Seymour	Color	Magnesium
Finish	Frosted	UPC Number	785007382495

Country Of Origin	China	Features	Antimicrobial Protection
Switch Type	Wave	Number of Switches	1
Device Front Face Size	Full-Size	Device Backbody Size	Plus-Size
Application Sector	Residential	Warranty Type	Limited Lifetime Warranty
Type	Decorator, Switch		

Dimensions

Product Width US	1.77 in	Product Depth US	1.71 in
Product Height US	2.66 in		

Listing Agencies / 3rd Party Agencies

cULus Listed	Yes
--------------	-----

Additional Information

RoHS Compliant	Yes
----------------	-----

Technical Information

Connection	Screw Terminals	Amperage	20 A
Number of Poles	Single Pole 3-Way	Wire Size	#14 - #10 AWG
Indoor/Outdoor	Indoor	Connection Type	Internal Pressure Plates
