

hover

barcelona lights

Noren

Noren S/72

Noren S/123 - S/123.2

Noren S/151 - S/151.2

Noren S/85

Noren S/100

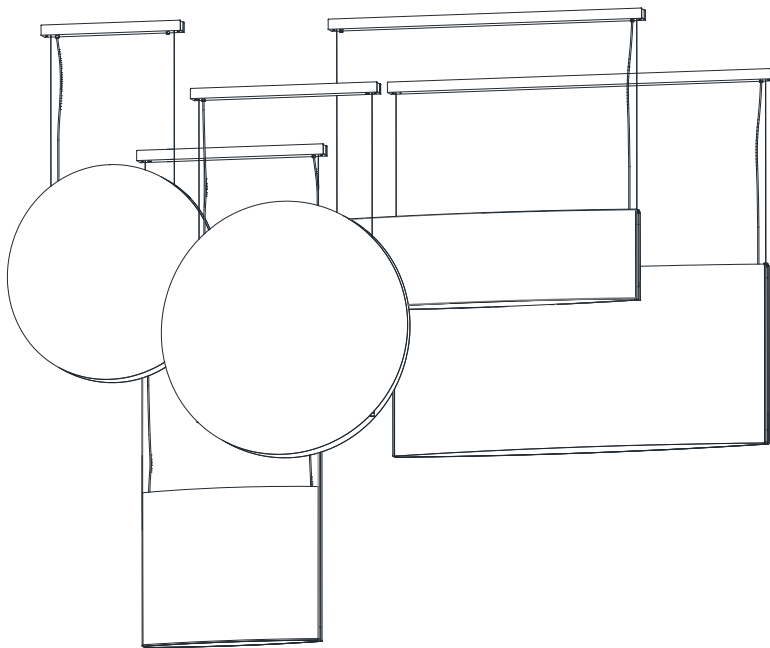

Noren S

Year/Année: 2022



Dry locations only.

Input voltage: 120V~ 60Hz

Pour emplacements secs seulement.

Tension d'entrée: 120V~ 60Hz

Top Lighting
Lumière du haut

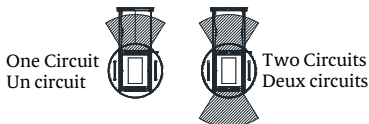

Bottom Light
Downlight (lumière du bas)

	Sup	Sup + Inf
Noren S/72	14.4W	14.4+7W
Noren S/123 - S/123.2	15.5W	15.5+7W
Noren S/151 - S/151.2	20.5W	20.5+7W
Noren S/85	14.4W	14.4+7W
Noren S/100	14.4W	14.4+7W

LUMINAIRES

CERTIFIED BY / CERTIFIÉ PAR

This product conforms to the standard UL Std 1598:2021

and it is Certified to CAN/ CSA C22.2#250.0:2021

Ce produit est conforme à la norme UL Std 1598:2021

et il est certifié conforme à la norme CAN/CSA C22.2#250.0:2021



ASSEMBLY INSTRUCTIONS

IMPORTANT SAFETY INSTRUCTIONS /

DANGER-RISK OF SHOCK-DISCONNECT POWER BEFORE INSTALLATION :

THIS PRODUCT MUST BE INSTALLED IN ACCORDANCE WITH THE APPLICABLE INSTALLATION CODE BY A PERSON FAMILIAR WITH THE CONSTRUCTION AND OPERATION OF THE PRODUCT AND THE HAZARDS INVOLVED.

DANGER - RISQUE DE CHOC - COUPER LE COURANT AVANT L'INSTALLATION :

MESURES DE SÉCURITÉ À RESPECTER:

CE PRODUIT DOIT ÊTRE INSTALLÉ CONFORMÉMENT AU CODE D'INSTALLATION APPLICABLE PAR UNE PERSONNE CONNAISSANT BIEN LA CONSTRUCTION ET LE FONCTIONNEMENT DU PRODUIT AINSI QUE LES DANGERS ASSOCIÉS.

Markings for models provided with an integral Class P LED driver:

CAUTION - RISK OF FIRE

ATTENTION - RISQUE D'INCENDIE

CAUTION - RISK OF SHOCK-DISCONNECT POWER BEFORE SERVICING

COUPER L'ALIMENTATION AVANT L'ENTRETIEN

THIS LUMINAIRE MUST BE MOUNTED OR SUPPORTED INDEPENDENTLY OF AN OUTLET BOX.

CE LUMINAIRE NE DOIT PAS ÊTRE MONTÉ SUR UNE BOÎTE DE SORTIE NI SUPPORTÉ PAR UNE TELLE BOÎTE.

CONNECTION TABLE TABLEAU DE CONNEXION	WIRE COLOUR	COULEUR DU FIL
L	BLACK	<i>NOIR</i>
N	WHITE / GREY	<i>BLANC</i>
⊕	GREEN	<i>VERT</i>
DIMMABLE / DIMABLE		
PUSH OR DALI	BLACK	<i>NOIR</i>
1-10V +	RED / PURPLE	<i>ROUGE / VIOLET</i>
1-10V -	WHITE / GREY	<i>BLANC / GRIS</i>

Supply Connections inspection:

To inspect the connections to the net simply remove the cover of the canopy (See Pictures 1 and 2)

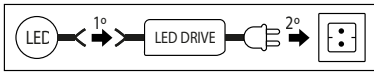

Wiring Sequence: To avoid damage to the luminaire, always connect the load to the Driver first before connecting to the mains.

Séquence de câblage : Pour éviter d'endommager le luminaire, connectez toujours la charge au driver avant de la connecter au réseau.

Verdrahtungsreihenfolge: Um Schäden an der Leuchte zu vermeiden, schließen Sie immer zuerst die Last an den Treiber an, bevor Sie das Netz anschließen.

Secuencia de Conexionado: Para evitar daños a la luminaria, siempre conectar primero la carga al Driver antes de conectarse a la Red.

Maintenance

Use a slightly-wet cotton cloth for cleaning.

In case of malfunction or damage, please contact the retailer who sold the lamp.

Mantenimiento

Para limpiar la luminaria, usar un paño de algodón ligeramente humedecido en agua.

En caso de avería o incidente con la luminaria, contactar directamente con el establecimiento en que se adquirió.

Instandhaltung

Zur Reinigung der Leuchte nutzen Sie einen leicht angefeuchteten Baumwoll-Lappen.

Im Falle des Ausfalls oder einer Fehlfunktion der Leuchte setzen Sie sich direkt mit dem Unternehmen in Verbindung bei dem Sie die Leuchte bezogen haben.

Entretien

Pour nettoyer le luminaire, utilisez un chiffon en coton légèrement humidifié d'eau.

En cas d'incident ou de défaillance du luminaire, contactez directement l'établissement où vous l'avez acheté.

Manutenzione

Per la pulizia della lampada, usare un panno di cotone leggermente inumidito con acqua.

In caso di guasto o incidente con la lampada, rivolgersi direttamente al rivenditore da cui è stata acquistata.

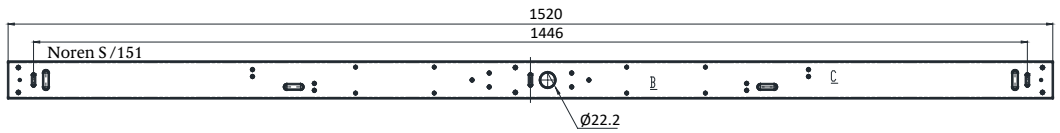
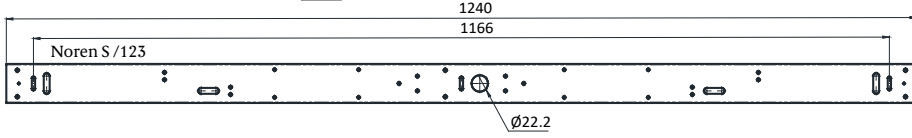
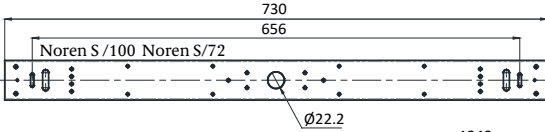
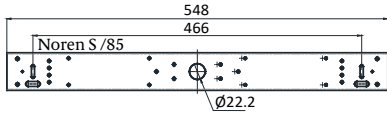

1

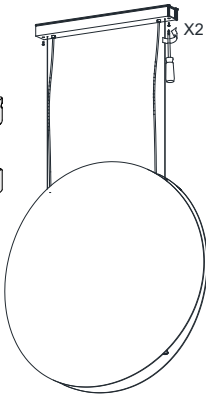
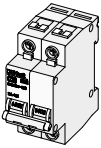

2

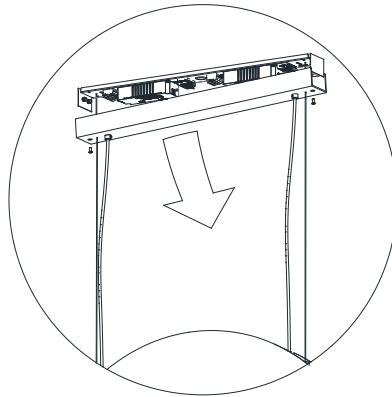

3

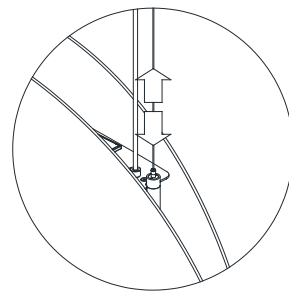
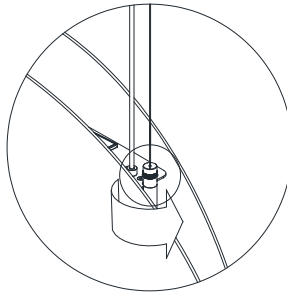
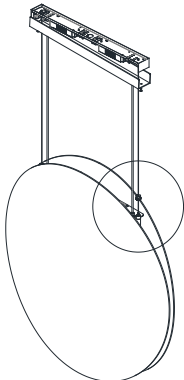



3

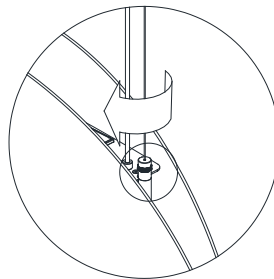
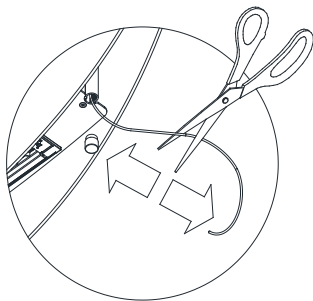
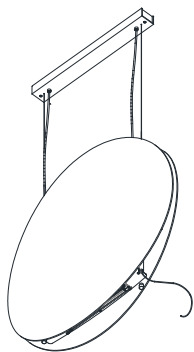

4

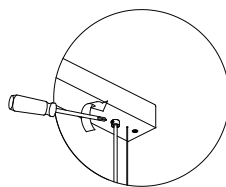
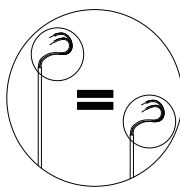
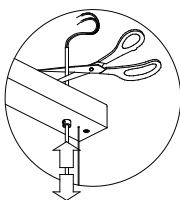
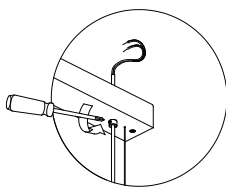

5

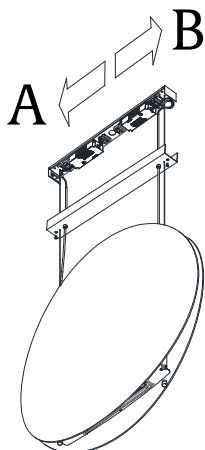

Un Circuito
One Circuit

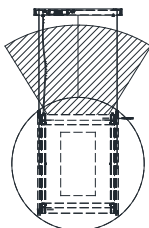

Dos Circuitos
Two Circuits

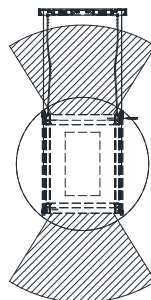

6

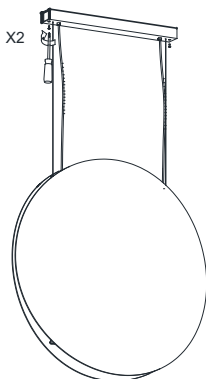

7

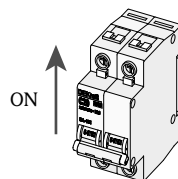

116 Noren S Rev 0.0 Read all the instructions-Save all the instructions
Lisez toutes les instructions - Conservez toutes les instructions

bover
barcelona lights

Avda. Catalunya 173
Poligon Ind. Sud
08440 Cardedeu
Barcelona, Spain

T. +34 938 713 152
F. +34 938 462 089
info@bover.es
www.bover.es

1231 Collier Road,
Suite C
Atlanta, GA 30318
United States

T. +1 (404) 924 2342
info@boverusa.com
www.boverusa.com