

CTL8030

PAR30 Saturna Line Voltage Track Fixture

Specifications/Features

Fixture

Elegant patented design. (Patent # D 345,616)
Die-cast aluminum housing.
Open design for cooler operation and convenient front relamping.
Steel dual-rail yoke design provides a "hi-tech", less bulky look.
Sure-Set yoke for precise aiming without tools and full 350° rotation.
Integral on/off switch and track polarity indicator are standard.
Will accept FA-30 accessory holder and one (1) LF30 lens.

Lamp/Electrical

Uses line voltage (120V) lamps for versatility and convenience.
(1) 75W max. PAR30, E26 medium base.

Warranty

This fixture is covered by ConTech's full one (1) year replacement guarantee after date of purchase.

Listing

cCSAus Certified. Suitable for dry locations.

Fixture Compatibility

Standard ConTech track fixtures are cCSAus certified as-is for use with ConTech's many track systems, as well as with Juno®¹ Lighting track. By changing the prefix in the part number, ConTech can install inserts which make our fixtures compatible with other manufacturers. Replace "CTL" with "HTL" for Halo®² track, "LTL" for Lightolier®³ track, and "PTL" for Capri®⁴ track. For more information, please consult our factory.

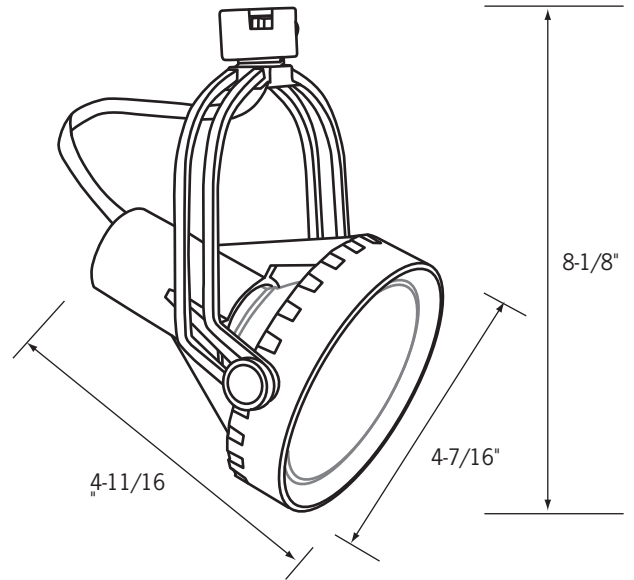

Ordering Information

Example Order: —

Track System	Fixture	Finish	Accessory Holder	Accessories
<input type="text"/>	<input type="text"/>	<input type="text"/>	<input type="text"/>	<input type="text"/>

CTL - ConTech
HTL - Halo
LTL - Lightolier
PTL - Capri

8030

B - Black
P - White
S - Silver
U - Unfinished Aluminum

FA-30-(B, P, S)

BD30* - Barn Doors
**Black is standard finish. Natural aluminum may be ordered by adding suffix "U".*
LA-38-(B, P, S) - Egg-Crate Louver
LF30-(A, B, CL, G, LB, R, RO, Y, 73, LS, SL, UV)
3-3/4" Tempered glass lenses

Color/Pattern Legend
-A (Amber), **-B** (Blue), **-CL** (Clear), **-G** (Green),
-LB (Light Blue), **-R** (Red), **-RO** (Rose),
-Y (Yellow), **-73** (Spread Lens),
-LS (Linear Spread Lens), **-SL** (Soft Light),
-UV (Optivex UV Filter)

1. Juno is a registered trademark of Juno Lighting
2. Halo is a registered trademark of Cooper Lighting
3. Lightolier is a registered trademark of Philips Lighting
4. Capri is a registered trademark of Philips Lighting