

Specifications/Features

Housing/Mounting

Solid housing design stands up to tough installation challenges. Versatile mounting features provide fast installation. For solid or suspended ceilings. Lamp housing is removable through ceiling aperture to access junction box. J-box has (3) 1/2" knockouts with spring latch access plates. Housing adjusts to various ceiling thicknesses with three (3) screws. Dual extension hanger bars span 15" - 25-1/4" with integral holding spikes for easy mounting to wood joists. Hanger bars may also be extended to rest on T-bar ceilings (optional clip-on T-bar hangers available).

Lamp/Electrical

(1) 50W 12V MR16, GU5.3 base.
Ceramic terminal block socket.
Class H Magnetic transformer, thermally protected. Mounted to junction box cover for snap on/off convenience.
Approved for (5) #12 AWG (max.) branch through-circuit 90°C wiring.
Can be used with low voltage magnetic dimming controls for optimal control of illumination.
Optional Electronic Transformer:
Input: 120V 60Hz; Output at max. load: 11.7V 40kHz
Short circuit and thermally protected.

Trims

Baffle, multiplier, wall wash, accent and adjustable trim options available to suit a broad range of applications. See "Trims for 3" Low Voltage Recessed Housings" spec sheet for details.
On trims designed for use with MR16 lamps, Con-Tech Lighting provides a clear, tempered safety glass. This safety glass should only be used with open MR16 lamps, and not used with MR16 lamps that contain an integral glass lens.

Warranty

This fixture is covered by ConTech's full one (1) year replacement guarantee after date of purchase.
Transformer has a one (1) year warranty.

Labels/Usage

cCSAus Certified. Suitable for damp locations.
City of Chicago approved, CCEA listed, when CP option is selected.

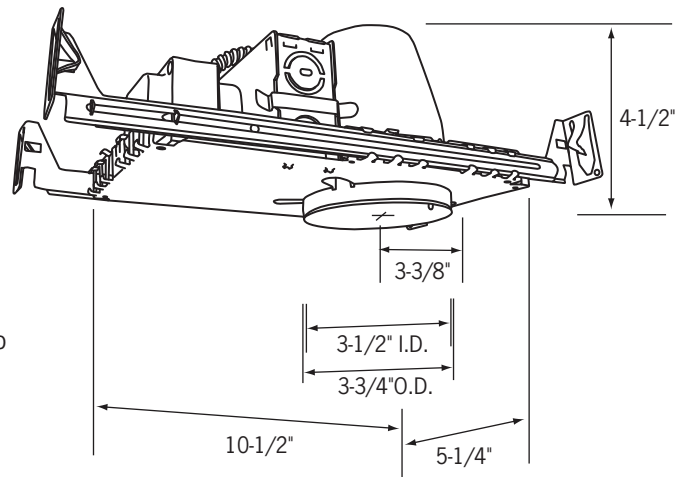

Ceiling Opening: 3-7/8"
Max. Ceiling Thickness: 1/2" - 1-1/4"

Ordering Information

Example Order:

Housing/Voltage

- LVR316** - 120V/12V
- LVR316 277V** - 277V/12V
- LVR316-E** - 120V/12V
Electronic Transformer

Trims

See "Trims for 3" Low Voltage Recessed Housings" spec sheet.

Options

- CP** - Chicago Plenum
- HB-24** - 27" Flat Hanger Set for RL-KIT
- HB-30** - Optional T-Bar Hanger Set
- HBC-24** - 25" C-Channel Hanger Set for RL-KIT

Specifications/Features

All trims have white trim finish unless specified.

All trims are cCSAus certified and suitable for damp locations; only shower trims are listed for wet locations.

On recessed trims designed for use with MR16 lamps, ConTech Lighting provides a clear, tempered safety glass. This safety glass should only be used with open MR16 lamps, and not used with MR16 lamps that contain an integral glass lens. If use of MR16 with front glass is required, remove the factory provided clear tempered safety lens. Glass lens should also be removed when using MR16 LED lamps.

For LED lamp compatibility, please consult factory.

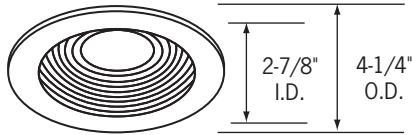

CTR301-B
Adjustable Black Baffle, Black Trim

CTR301-P
Adjustable Black Baffle

CTR301-WHT
Adjustable White Baffle

15° Vertical swing, 45mm lens. Trim can hold up to two (2) lenses with stepped lens holder (included). Insert 45mm lens on lower level of lamp seat, insert 50mm lens onto higher level.

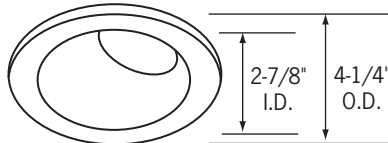

CTR304-B-BL
Angled Wall Wash; Black Reflector

CTR304-P-CLR
Angled Wall Wash; Clear Specular Reflector

CTR304-S-PL
Angled Wall Wash; Platinum Reflector, Silver Trim
Adjustable lampholder with 55-75° aiming angle. 45mm Lens. Trim can hold up to two (2) lenses with stepped lens holder (included). Insert 45mm lens on lower level of lamp seat, insert 50mm lens onto higher level.

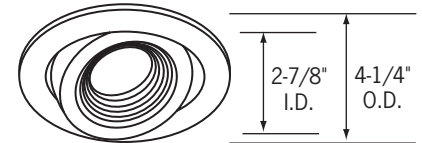

CTR307-(P, B, NK)
Adjustable Pin Spot; Black Baffle, Select Trim Finish

CTR307-WHT
Adjustable Pin Spot; White Baffle, White Trim
Deep baffle for maximum lamp concealment. May be used as a pin spot style downlight or an adjustable accent light. 35° Vertical adjustment. 45mm Lens. Trim can hold up to two (2) lenses with stepped lens holder (included). Insert 45mm lens on lower level of lamp seat, insert 50mm lens onto higher level.

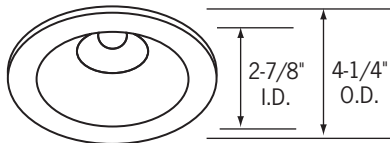

CTR302-B-BLK
Adjustable Multiplier; Black Metal Trim Ring, Black Reflector

CTR302-P-(CLR, BLK, WHT)
Adjustable Multiplier; White Metal Trim Ring, Select Reflector Finish

CTR302-(ST, NK)-CLR
Adjustable Multiplier; Select Metal Trim Finish, Clear Reflector
37° Vertical adjustment, 45mm lens. Trim can hold up to two (2) lenses with stepped lens holder (included). Insert 45mm lens on lower level of lamp seat, insert 50mm lens onto higher level.

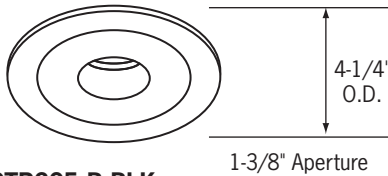

CTR305-B-BLK
Pin Spot; Black Cut-Off Reflector, Black Trim Ring

CTR305-CLR
Pin Spot; Clear Cut-Off Reflector
Downlight Only, 50mm Lens. Trim can hold up to two (2) lenses with stepped lens holder (included). Insert 45mm lens on lower level of lamp seat, insert 50mm lens onto higher level.

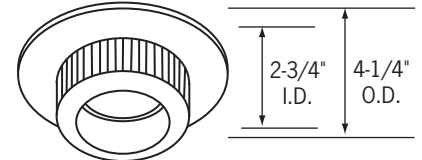

CTR310-F-P
Fluted Frosted Glass Diffuser
Must use Front Glass MR16 Lamp. 1-1/4"
Drop from ceiling. Cylindrical shape focuses light downward, eliminates glare.

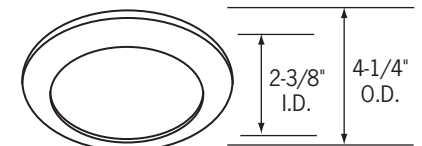

CTR311FR-(NK, P)
Frosted Flat Glass; Select Trim Finish
Shower light trim, double neoprene gasketed. cULus Listed for wet location.

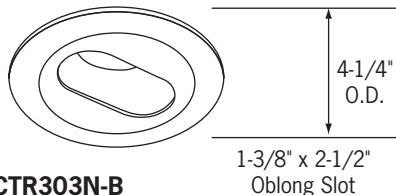

CTR303N-B
Slotted Wall Wash; Black Trim

CTR303N-P
Slotted Wall Wash; White Trim

Internal 50° swing adjustment (25° from Nadir), external 358° rotation. Slot aperture permits maximum beam area adjustment for either wall wash or concealed accent lighting effects. Black interior surface.

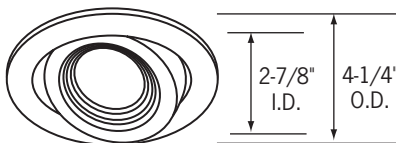

CTR306-P
Surface Adjustable; Black Baffle
40° Vertical adjustment, 359° horizontal rotation. 50mm Lens. Regressed black baffle reduces surface brightness. Flat, stainless mounting clips hold trim firmly to ceiling. Trim can hold up to two (2) lenses with stepped lens holder (included). Insert 45mm lens on lower level of lamp seat, insert 50mm lens onto higher level.

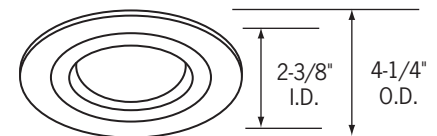

CTR312-P
Flat Glass; White Trim
Etched Glass for light diffusion.

Catalog No. _____

Type _____

Project _____

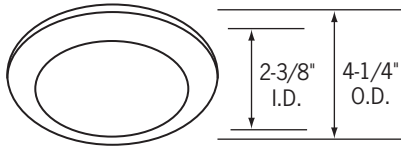

CTR313-P

Convex Drop Lens; Select Trim Finish
Shower light trim. 3/4" Drop (ceiling to bottom of glass), double neoprene gasketed. cULus listed for wet location.

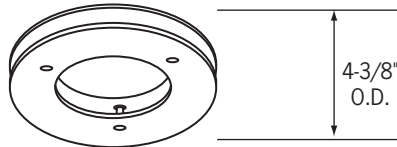

CTR317-P

Floating Ring; White Trim
Decorative floating glass ring, 2" center opening. Clear reflector with diffuse plastic cone. 1-1/8" Drop from ceiling. Cast aluminum trim construction. 50mm Lens.

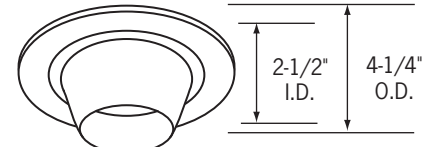

CTR318-F

White Frosted Glass Cone
Must use Front Glass MR16 Lamp. Tapered glass diffuser, specular reflector. 1-1/4" Drop from ceiling. 50mm Lens.

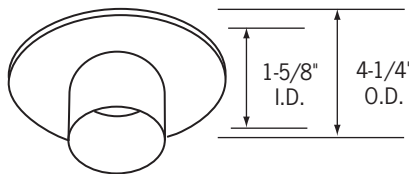

CTR321-F-(NK, P)

Frosted Glass Cylinder; Select Trim finish
Cylindrical glass diffuser, specular reflector. Light is focused downward, glare is eliminated. Cast aluminum trim construction. 1-1/4" Drop from ceiling.

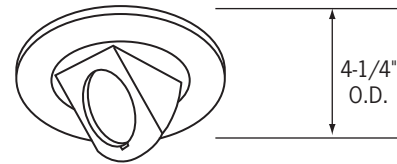

CTR324-(P, NK, ST)

Fully Adjustable; Select Finish
Unsurpassed aiming flexibility: 87° vertical, 359° rotational. Front access, spring latch lamp retainer ring, black finish (optional white retainer ring available: **1623/224 WHITE**, ordered separately). Exclusive stainless flat springs insure firm, close-to-ceiling mounting. Accepts only one 47mm lens; if louver is required (**FA-16 45MM**), remove safety lens and use front glass MR16 lamp.

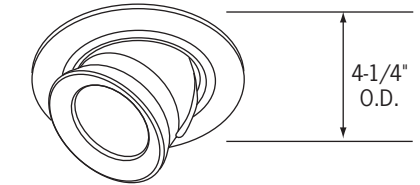

CTR325-(P, B, NK)

Fully Adjustable; Select Finish
Die cast, fully adjustable, round lampholder and backplate. Easy relamping with twist-off front retaining ring. Unsurpassed aiming flexibility: 87° vertical, 359° rotational. 50mm lens.



CTR335-(B, CO, P)

Elbow; Select Finish
Exceptional aiming flexibility with 87° vertical, 359° rotation adjustment. Die-cast aluminum construction. Front access, spring latch lamp retainer ring, black finish (optional white retainer ring available: **1623/224 WHITE**, ordered separately). Maximum depth from ceiling: 2-1/2". 47mm lens. Accepts only one 47mm lens; if louver is required (**FA-16 45MM**), remove safety lens and use front glass MR16 lamp.

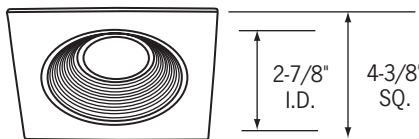

CTR301SQ-B

Adjustable Black Baffle, Black Trim

CTR301SQ-P

Adjustable Black Baffle, White Trim

CTR301SQ-WHT

Adjustable White Baffle, White Trim

Deep baffle traps stray light and conceals the lamp. May be used as a downlight or adjustable accent light 15° Vertical swing, 45mm lens. Trim can hold up to two (2) lenses with stepped lens holder (included). Insert 45mm lens on lower level of lamp seat, insert 50mm lens onto higher level.

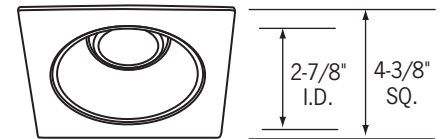

CTR302SQ-B-(BLK, CLR)

Adjustable Multiplier; Black Trim, Black or Clear Reflector

CTR302SQ-P-(CLR, WHT)

Adjustable Multiplier; White Trim, Clear or White Reflector

Multipliers utilize a highly polished, specular reflector to maximize light intensity while concealing the light source. May be used as a downlight or adjustable accent light.

37° Vertical adjustment, 45mm lens. Trim can hold up to two (2) lenses with stepped lens holder (included). Insert 45mm lens on lower level of lamp seat, insert 50mm lens onto higher level.

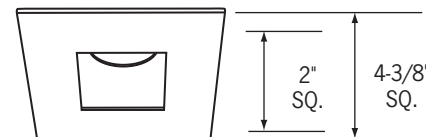

CTR305SQ-SQ-B-CLR

Square Pin Spot, Black Trim, Clear Reflector

CTR305SQ-SQ-P-CLR

Square Pin Spot, White Trim, Clear Reflector

CTR305SQ-SQ-NK-CLR

Square Pin Spot, Brushed Nickel Trim, Clear Reflector

Downlight Only, 50mm Lens.



CTR306SQ-B

Surface Adjustable Black Trim; Black Baffle

CTR306SQ-P

Surface Adjustable White Trim; Black Baffle

40° Vertical adjustment, 359° horizontal rotation. 50mm Lens. Regressed black baffle reduces surface brightness. Flat, stainless mounting clips hold trim firmly to ceiling.

Reflector/Trim Finish Legend

All finishes are not available for all trims.

Reflector Finish Options:

BLK - Black Specular CLR - Clear Specular
PL - Matte Platinum WHT - White Specular

Trim Finish Options:

B - Black NK - Nickel
BC - Black Chrome P - White
C - Chrome S - Silver
CO - Brushed Copper ST - Brushed Stainless Steel