

## SPECIFICATION SHEET

**Ardito LED - A2RSF**

2-1/2" Series

**Ultra-Thin Profile Round Regressed Shower Trim**

Project \_\_\_\_\_

Notes \_\_\_\_\_

Fixture Type \_\_\_\_\_

Date \_\_\_\_\_



A2RSF-22-XXX (illustrated)

Ultra-Thin Profile Round Regressed Shower Trim 2-1/2" high-efficiency dimmable LED downlight. Offered in Remodel NON-IC (with optional mounting plate), new construction NON-IC and new construction IC configurations.



## SPECIFICATIONS

TRIM DETAILS	<p>Requires a 5" (127 mm) clearance beyond the ceiling level when used with remodel or new construction NON-IC housings.</p> <p>Each part of the housing should be at LEAST 3" (76 mm) from insulation (non-IC configurations)</p> <p>Can fit in ceiling from 1/2" (12 mm) to 1-3/8" (35 mm) thick</p> <p>Accessible from below the ceiling for ease of maintenance.</p>
HEAT SINK	High-quality injection molded aluminum heat sink ensuring maximum heat dissipation for optimal performance.
CEILING CUTOUT	<b>ø 2-5/8" (67 mm)</b>
CERTIFICATION	<ul style="list-style-type: none"> <li>• cULus <b>E343977</b> for wet locations</li> <li>• Certified under California Energy Commission according to reference joint Appendix 8 (JA8-2016)</li> <li>• Certified Air Tight ASTM E283</li> </ul>
WARRANTY	<p>1 year on components against manufacturing defects</p> <p>5 years on LED arrays and drivers</p>

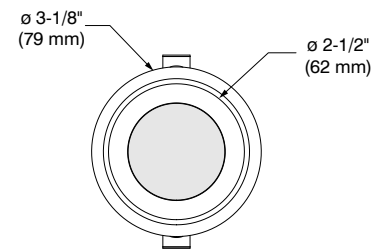
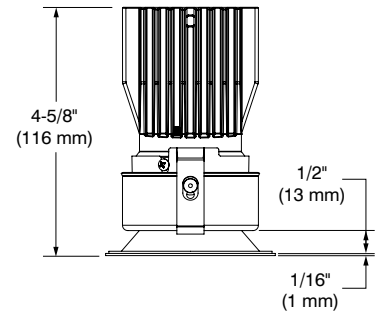
**CONTRASTE**2018-02  
Revision 1

PRINTED IN CANADA

1009, rue du Parc Industriel  
Lévis (Québec) G6Z 1C5 Canada  
Tel.: 1-888-839-4624  
Fax.: 1-877-839-7057  
contrastelighting.com  
info@contrastelighting.com

© 2018 Contraste Lighting M.L. Inc.  
All rights reserved

Contrast Lighting M.L. Inc. reserves the right to make changes in specifications and/or to discontinue any product at any time without notice or obligation and will not be liable for any consequences resulting from the use of this publication.

## SPECIFICATION SHEET

**Ardito LED - A2RSF**

2-1/2" Series

**Ultra-Thin Profile Round Regressed Shower Trim**

## SPECIFICATIONS (CONT'D)

## COMPATIBLE HOUSINGS

	Remodel Housing	New Construction Housing	Insulated Air Tight Housing (Title 24)
<b>Performance 1 (14W)</b>	REA2V1	NWA2RV1	ICAT0R2-ARV1 

For dimming, please visit our Web site frequently to find our suggested compatible dimmers: [www.contrastlighting.com](http://www.contrastlighting.com)

## LIGHT ENGINE

**STANDARD (SOLID WHITE)**

Lumileds Luxeon CoB 1203 GEN3.

L<sub>70</sub> @ 50,000 hours of operation.

3-Step MacAdam ellipse (3 SDCM)

Color Temperatures: 2,700K - 3,000K - 3,500K - 4,000K

CRI: 90+

R9: &gt;50

Delivered Lumens: Performance 1 (14W) **with clear lens** - up to 1,375 lumens (95 lm/W)Performance 1 (14W) **with frosted lens** - up to 975 lumens (68 lm/W)

Power Supply: 120V / 277V (universal input)

One driver available in performance 1 (14W) and offering 2 dimming options within the same unit:

ELV: 120V only

0-10V: 120V / 277V

Consult housing specification sheet for more details.

## OPTIC SYSTEM

Interchangeable optional optical reflectors and lenses available to customize your lighting.

**Choice of available lenses:****Clear (C)** **Frosted (F)****Optical reflectors available:** Spot, Narrow Flood, Flood, Wide Flood**Standard**

Spot ( <b>S</b> )	15°
Narrow Flood ( <b>M</b> )	24°
Flood ( <b>L</b> )	36°
Wide Flood ( <b>V</b> )	60°

**Average beams shown. Consult .ies files on our Web site for more details.**

## FLANGE AND REFLECTOR FINISHES

Powder coat painted or plated die formed steel.

**Different finishes available:**24K Gold Plated (**-03**), Chrome (**-04**), Brushed Chrome (**-04BR**), Matte White (**-11**), Brushed Nickel (**-12BR**), Satin Nickel (**-13**), Matte Black (**-22**) and Polar Grey (**-25**)**CONTRASTE**2018-02  
Revision 1

PRINTED IN CANADA

1009, rue du Parc Industriel  
Lévis (Québec) G6Z 1C5 Canada  
Tel.: 1-888-839-4624  
Fax.: 1-877-839-7057  
contrastlighting.com  
info@contrastlighting.com© 2018 Contraste Lighting M.L. Inc.  
All rights reserved

Contrast Lighting M.L. Inc. reserves the right to make changes in specifications and/or to discontinue any product at any time without notice or obligation and will not be liable for any consequences resulting from the use of this publication.

## SPECIFICATION SHEET

**Ardito LED - A2RSF**

2-1/2" Series

**Ultra-Thin Profile Round Regressed Shower Trim**

## TRIM WITH FLANGE CODIFICATION EXAMPLE

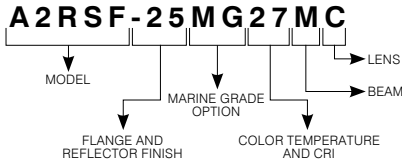
ORDERING CODES **A2RSF**

MODEL	FLANGE AND REFLECTOR FINISHES	MARINE GRADE	COLOR TEMPERATURES AND CRI	BEAMS	LENSES
<b>A2RSF</b>					
<b>A2RSF</b>	<b>-03</b> 24K Gold Plated	<b>MG</b> (optional)	<b>27</b> 2,700K (90+ CRI)	<b>S</b> Spot (15°)	<b>C</b> Clear
	<b>-04</b> Chrome	May be applied	<b>30</b> 3,000K (90+ CRI)	<b>M</b> Narrow Flood (24°)	<b>F</b> Frosted
	<b>-04BR</b> Brushed Chrome	on finishes:	<b>35</b> 3,500K (90+ CRI)	<b>L</b> Flood (36°)	
	<b>-11</b> Matte White	11, 22 and 25	<b>40</b> 4,000K (90+ CRI)	<b>V</b> Wide Flood (60°)	
	<b>-12BR</b> Brushed Nickel				
	<b>-13</b> Satin Nickel				
	<b>-22</b> Matte Black				
	<b>-25</b> Polar Grey				

## MARINE GRADE

2-year warranty on finish

This option increases the painted finishes resistance by reducing and delaying apparition and propagation of oxidation (ex: rust and others).

MARINE GRADE treatment is recommended for damp to wet locations.

Unless otherwise indicated, trims are for interior use. Also suitable for cold and exterior locations, as in soffits, where fixtures are not subject to direct rain or snow exposure.

**WARNING** – This option is not suitable for salt environments and/or highly corrosive areas such as soffits in coastal regions and natatoriums. Such usage would void warranty on the product.**CONTRASTE**2018-02  
Revision 1

PRINTED IN CANADA

1009, rue du Parc Industriel  
Lévis (Québec) G6Z 1C5 Canada  
Tel.: 1-888-839-4624  
Fax.: 1-877-839-7057  
contrastelighting.com  
info@contrastelighting.com© 2018 Contraste Lighting M.L. Inc.  
All rights reserved

Contrast Lighting M.L. Inc. reserves the right to make changes in specifications and/or to discontinue any product at any time without notice or obligation and will not be liable for any consequences resulting from the use of this publication.

# Ardito LED - A2RSF

2-1/2" Series

## Ultra-Thin Profile Round Regressed Shower Trim

### ORDERING CODES

#### for replacement lenses and reflectors

For future on-site modifications of the light distribution.

#### Lenses (to modify light diffusion)

Clear (C): **103584**

Frosted (F): **316228**

#### Reflectors (to modify the beam angle)

For a Spot (15°): **104419**

For a Narrow Flood (24°): **104420**

For a Flood (36°): **104421**

For a Wide Flood (60°): **104422**

### PHOTOMETRIC DATA

In order to obtain the accurate photometric data, multiply the lumens relative to your product selection by the applicable factor(s).  
Take note these factors also need to be implemented in the .ies files available on our website.

	Spot (15°)		Narrow Flood (24°)		Flood (36°)		Wide Flood (60°)	
<b>2,700K with 90+ CRI</b>	1,225 lm	85.1 lm/W	1,080 lm	75 lm/W	1,075 lm	74.6 lm/W	1,070 lm	74.3 lm/W
<b>3,000K with 90+ CRI</b>	1,270 lm	88.2 lm/W	1,115 lm	77.4 lm/W	1,110 lm	77.1 lm/W	1,105 lm	76.7 lm/W
<b>3,500K with 90+ CRI</b>	1,340 lm	93.1 lm/W	1,180 lm	81.9 lm/W	1,175 lm	81.6 lm/W	1,170 lm	81.3 lm/W
<b>4,000K with 90+ CRI</b>	1,375 lm	95.5 lm/W	1,210 lm	84 lm/W	1,205 lm	83.7 lm/W	1,200 lm	83.3 lm/W

Lens Factors	
<b>C</b>	1
<b>F</b>	0.71

# Ardito LED - A2RSF

2-1/2" Series

Ultra-Thin Profile Round Regressed Shower Trim

PHOTOMETRIC DATA



### 3,000K, 90+ CRI, Spot, performance 1 — WITH CLEAR LENS

**CANDLEPOWER DISTRIBUTION**

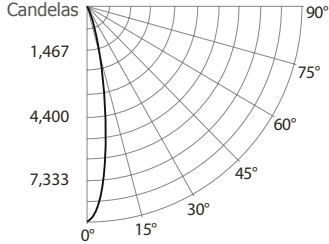

**LIGHT CONE**

Distance	FC	DIA
06'	242.1	1.7'
08'	136.2	2.3'
10'	87.2	2.8'
12'	60.5	3.4'
14'	44.5	4.0'
16'	34.0	4.5'

**Beam:** 16°  
Beam Edge defined as 50% of Maximum Nadir Candle-power.

**LUMINAIRE**

<b>Performance 1 LED</b>	3,000K	Spot
<b>CBCP / Lumens</b>	8,715	/ 1,267.3
<b>Watts</b>	120V	277V
	14.4W	14.9W
<b>Operating AMPS</b>	0.12A	0.054A
<b>Lumen Maintenance</b>	L70 @ 50,000 Hrs	
<b>CRI</b>	90+	
<b>Lumens/Watt</b>	88	
<b>Spacing Criteria</b>	0.07	

**COEFFICIENT OF UTILIZATION - %**

Ceiling Reflect %	80	50	30
<b>Wall Reflect %</b>	<b>50</b>	<b>30</b>	<b>50</b>
<b>RCR</b>	0	119	119
	111	111	106
	106	106	106
	2	108	105
	103	101	100
	99	99	99
	4	100	96
	97	94	95
	92	92	92
	6	93	89
	91	88	90
	87	87	85
	82	82	82
	8	87	83
	86	83	85
	82	78	81
	78	78	78

**Zonal Cavity Method**  
Effective Floor Cavity Reflectance 20%

**ZONAL LUMEN SUMMARY**

ZONE	LUMENS	%LUMINAIRE
0-30	1,114.8	94.8%
0-40	1,176.1	100%
0-60	1,176.1	100%
60-90	0.0	0%
0-180	1,176.1	100%

**MULTIPLE UNIT DATA - (RCR 2)**

SPACING ON CENTER	INITIAL FOOTCANDLES	WATTS/SQ. FT.
5'	59	0.64
6'	33	0.36
7'	23	0.25
8'	23	0.25
9'	15	0.16

38' x 38' x 10' Room. Workplan located 2-1/2' (30").  
Reflectance factor 80%/50%/30%

**CANDELAS DISTRIBUTION**

DEGREES/VERTICAL	CANDELAS	DEGREES/VERTICAL	CANDELAS
0	8,715	40	0
5	6,473	50	0
10	3,037	60	0
15	1,150	70	0
20	724	80	0
25	535	90	0
30	328		

### 3,000K, 90+ CRI, Narrow Flood, performance 1 — WITH CLEAR LENS

**CANDLEPOWER DISTRIBUTION**

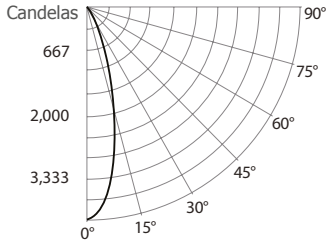

**LIGHT CONE**

Distance	FC	DIA
06'	111	2.9'
08'	62.5	3.9'
10'	39.9	4.8'
12'	27.8	5.8'
14'	20.4	6.7'
16'	15.6	7.7'

**Beam:** 27°  
Beam Edge defined as 50% of Maximum Nadir Candle-power.

**LUMINAIRE**

<b>Performance 1 LED</b>	3,000K	Narrow Flood
<b>CBCP / Lumens</b>	3,997	/ 1,133.8
<b>Watts</b>	120V	277V
	14.4W	14.9W
<b>Operating AMPS</b>	0.12A	0.054A
<b>Lumen Maintenance</b>	L70 @ 50,000 Hrs	
<b>CRI</b>	90+	
<b>Lumens/Watt</b>	78.7	
<b>Spacing Criteria</b>	0.12	

**COEFFICIENT OF UTILIZATION - %**

Ceiling Reflect %	80	50	30
<b>Wall Reflect %</b>	<b>50</b>	<b>30</b>	<b>50</b>
<b>RCR</b>	0	119	119
	111	111	106
	106	106	106
	2	107	104
	102	100	99
	97	94	91
	92	90	92
	6	90	85
	87	84	86
	83	81	77
	77	73	76
	76	73	76
	72	72	72

**Zonal Cavity Method**  
Effective Floor Cavity Reflectance 20%

**ZONAL LUMEN SUMMARY**

ZONE	LUMENS	%LUMINAIRE
0-30	1,055.6	93.1%
0-40	1,130.2	99.7%
0-60	1,133.8	100%
60-90	0.0	0%
0-90	1,133.8	100%

**MULTIPLE UNIT DATA - (RCR 2)**

SPACING ON CENTER	INITIAL FOOTCANDLES	WATTS/SQ. FT.
5'	56	0.64
6'	32	0.36
7'	22	0.25
8'	22	0.25
9'	14	0.16

38' x 38' x 10' Room. Workplan located 2-1/2' (30").  
Reflectance factor 80%/50%/30%

**CANDELAS DISTRIBUTION**

DEGREES/VERTICAL	CANDELAS	DEGREES/VERTICAL	CANDELAS
0	3,997	40	14
5	3,654	50	1
10	2,742	60	0
15	1,699	70	0
20	944	80	0
25	570	90	0
30	337		

# Ardito LED - A2RSF

2-1/2" Series

Ultra-Thin Profile Round Regressed Shower Trim

PHOTOMETRIC DATA



### 3,000K, 90+ CRI, Flood performance 1 — WITH CLEAR LENS

**CANDLEPOWER DISTRIBUTION**

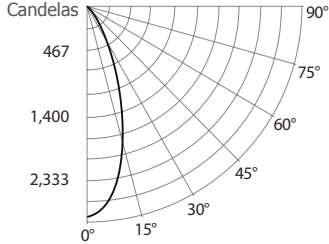

**LIGHT CONE**

Distance	FC	DIA
06'	76.3	3.7'
08'	42.9	5.0'
10'	27.5	6.2'
12'	19.1	7.5'
14'	14	8.7'
16'	10.7	10'

**Beam:** 35°  
Beam Edge defined as 50% of Maximum Nadir Candle-power.

**LUMINAIRE**

<b>Performance 1 LED</b>	3,000K Flood
<b>CBCP / Lumens</b>	2,745 / 1,084.3
<b>Watts</b>	120V 277V 14.4W 14.9W
<b>Operating AMPS</b>	0.12A 0.054A
<b>Lumen Maintenance</b>	L70 @ 50,000 Hrs
<b>CRI</b>	90+
<b>Lumens/Watt</b>	75.3
<b>Spacing Criteria</b>	0.15

**COEFFICIENT OF UTILIZATION - %**

Ceiling Reflect %	80		50		30		
Wall Reflect %	50	30	50	30	50	30	
<b>RCR</b>	0	119	119	111	111	106	106
	2	106	103	101	99	98	96
	4	96	91	93	89	91	88
	6	87	83	85	81	84	80
	8	80	75	79	75	78	74
	10	74	70	73	69	72	69

**Zonal Cavity Method**  
Effective Floor Cavity Reflectance 20%

**ZONAL LUMEN SUMMARY**

ZONE	LUMENS	%LUMINAIRE
0-30	997.4	92%
0-40	1065.6	98.3%
0-60	1081.4	99.7%
60-90	2.9	0.3%
0-180	1084.3	100%

**MULTIPLE UNIT DATA - (RCR 2)**

SPACING ON CENTER	INITIAL FOOTCANDLES	WATTS/SQ. FT.
5'	54	0.64
6'	30	0.36
7'	21	0.25
8'	21	0.25
9'	13	0.16

38' x 38' x 10' Room. Workplan located 2-1/2' (30").  
Reflectance factor 80%/50%/30%

**CANDELAS DISTRIBUTION**

DEGREES/VERTICAL	CANDELAS	DEGREES/VERTICAL	CANDELAS
0	2,745	40	22
5	2,612	50	8
10	2,246	60	5
15	1,659	70	1
20	1,083	80	0
25	677	90	0
30	338		

### 3,000K, 90+ CRI, Wide Flood, performance 1 — WITH CLEAR LENS

**CANDLEPOWER DISTRIBUTION**

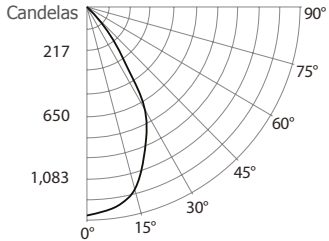

**LIGHT CONE**

Distance	FC	DIA
06'	35.7	7.1'
08'	20.1	9.5'
10'	12.9	11.9'
12'	8.9	14.2'
14'	6.6	16.6'
16'	5.0	19.0'

**Beam:** 61°  
Beam Edge defined as 50% of Maximum Nadir Candle-power.

**LUMINAIRE**

<b>Performance 1 LED</b>	3,000K Wide Flood
<b>CBCP / Lumens</b>	1,285 / 1,211.5
<b>Watts</b>	120V 277V 14.4W 14.9W
<b>Operating AMPS</b>	0.12A 0.054A
<b>Lumen Maintenance</b>	L70 @ 50,000 Hrs
<b>CRI</b>	90+
<b>Lumens/Watt</b>	84.1
<b>Spacing Criteria</b>	0.25

**COEFFICIENT OF UTILIZATION - %**

Ceiling Reflect %	80		50		30		
Wall Reflect %	50	30	50	30	50	30	
<b>RCR</b>	0	119	119	111	111	106	106
	2	103	98	98	95	95	92
	4	89	83	85	81	83	80
	6	78	71	75	70	74	69
	8	68	62	67	61	66	61
	10	61	55	60	54	59	54

**Zonal Cavity Method**  
Effective Floor Cavity Reflectance 20%

**ZONAL LUMEN SUMMARY**

ZONE	LUMENS	%LUMINAIRE
0-30	829.0	68.4%
0-40	1,070.9	88.4%
0-60	1,206.8	99.6%
60-90	4.7	0.4%
0-90	1,211.5	100%

**MULTIPLE UNIT DATA - (RCR 2)**

SPACING ON CENTER	INITIAL FOOTCANDLES	WATTS/SQ. FT.
5'	58	0.64
6'	33	0.36
7'	23	0.25
8'	23	0.25
9'	15	0.16

38' x 38' x 10' Room. Workplan located 2-1/2' (30").  
Reflectance factor 80%/50%/30%

**CANDELAS DISTRIBUTION**

DEGREES/VERTICAL	CANDELAS	DEGREES/VERTICAL	CANDELAS
0	1,285	40	208
5	1,275	50	71
10	1,239	60	9
15	1,135	70	1
20	992	80	0
25	864	90	0
30	685		