

SPECIFICATION SHEET

Ardito LED - A3SAR

3-1/2" Series

Ultra-Thin Profile Square Adjustable Regressed Trim

Project _____

Notes _____

Fixture Type _____

Date _____



WITH FLANGE

A3SAR-1111 - XXX (illustrated)



FLANGELESS TRIM

A3SAR-TR11 - XXX (illustrated)

Aluminum square, adjustable, 3-1/2" high efficiency regressed dimmable LED downlight allowing up to 30° tilt. Adjustable and lockable from below the ceiling. May be installed with a low profile ultra-thin flange or flangeless trim in configuration for insulated, non-insulated and remodel (non-IC) ceilings.

SPECIFICATIONS



TRIM DETAILS

Requires a 6-1/2" (165 mm) clearance beyond the ceiling level for standard using and 7" (178 mm) for Lumenetix option using.

Perfect fit into ceiling

Each part of the housing should be at LEAST 3" (76 mm) from insulation (non-IC configurations)

Can fit in ceilings up to 1-1/2" (38 mm) thick

Junction box is accessible from below the ceiling for ease of maintenance

AJUSTABILITY

Tilt: 30°

Locking device: choose aiming angle then tighten the screw to lock both axis into position from below the ceiling.

HEAT SINK

High quality injection molded aluminum heat sink ensuring maximum heat dissipation for optimal performance.

CEILING CUTOUT

3-3/4" (95 mm) x 3-3/4" (95 mm)

Included: Cardboard cutout template

Optional: Reusable steel cutout template for square trim **(TEMP-SQ)**

CERTIFICATION

- cULus **E343977** for damp locations
- Certified under California Energy Commission according to reference joint Appendix 8 (JA8-2016)
- Air Tight when used with ICAT Housing

WARRANTY

1 year on components against manufacturing defects

5 years on LED arrays and drivers

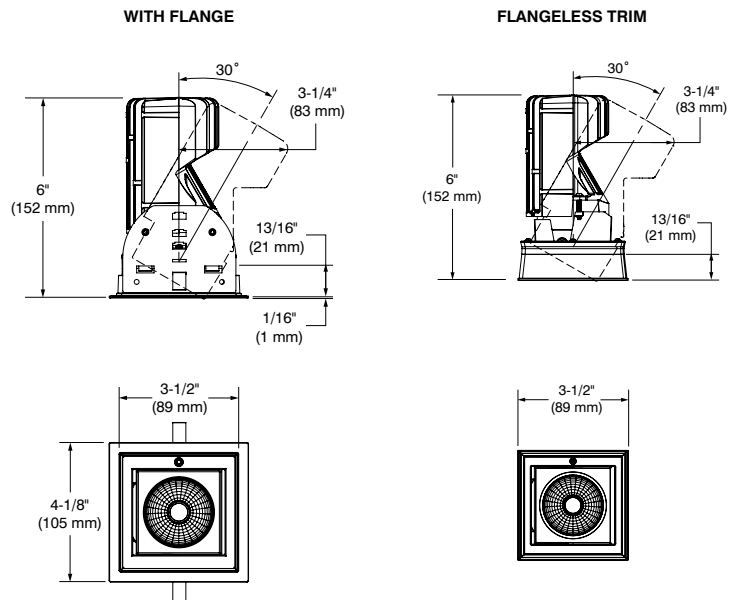

Ardito LED - A3SAR

3-1/2" Series**Ultra-Thin Profile Square Adjustable Regressed Trim**

SPECIFICATIONS (CONT'D)

LIGHT ENGINE

STANDARD (SOLID WHITE)

Lumileds Luxeon CoB 1205 GEN3 for Narrow Flood and Flood beams. Lumileds Luxeon CoB 1203 GEN3 for Spot beam.

L₇₀ @ 50,000 hours of operation.

3-Step MacAdam ellipse (3 SDCM)

Color Temperatures: 2,700K - 3,000K - 3,500K - 4,000K

CRI: 90+ (93 typical)

R9: >50

Delivered Lumens: Performance 1 (14W) - 1,356 lumens @ 3,000K, 96 lm/W
Performance 2 (23W) - 1,923 lumens @ 3,000K, 81 lm/W

Power Supply: 120V / 277V (universal input)

One driver available in 2 performances (14W and 23W) and offering 2 dimming options within the same unit:

ELV: 120V only 0-10V: 120V / 277V

Consult housing specification sheet for more details.

WARM DIMMING (WD)

Lumenetix Araya DDM1 Dynamic Dimming Module. Delivers dimmable (100% - 1%) white light that warms as it dims, reproducing dimming conditions of a halogen lamp. It allows the user to change the color temperature from 3,050K to 1,800K at minimum intensity all this while ensuring a 90+ CRI over the full dimming range.

L₇₀ @ 50,000 hours of operation.

2-Step MacAdam ellipse (2 SDCM)

Color Temperatures: 3,050K to 1,800K

CRI: 90+ (over the entire dimming range)

Delivered Lumens: Performance L (12.5W) - up to 700 lumens

Power Supply: 120V - 277V (universal input)

One driver available in one performance (12.5W) and offering one dimming option:

0-10V: 120V / 277V

Consult Lumenetix Website (www.lumenetix.com) and refer to the documentation for the DDM119 module for more information.**COLOR TUNING (CT)**

Lumenetix Araya CTM1 Color Tuning Module. Delivers tunable and dimmable (100% - 1%) white light from 1,650K to 4,000K as well as millions of colors.

L₇₀ @ 50,000 hours of operation.

2-Step MacAdam ellipse (2 SDCM)

Color Temperatures: 1,650K to 4,000K (adjustable)

CRI: 90+ (for all solid white)

Delivered Lumens: Performance L (12.5W) - up to 700 lumens

Power Supply: 120V - 277V (universal input)

One driver available in one performance (12.5W) and offering different control options:

DMX512-A: 4 channels - DIM (dim level) - CCT (correlated color temperature)
- SAT (saturation level) - HUE (color)

0-10V: One dimmer per channel (ex.: DIM and CCT)

"Araya 5" iOS App. (free): Allows programming of up to 5 scenes. The App. can be used to override the cabled system.

Consult Lumenetix Website (www.lumenetix.com) and refer to the documentation for the CTM119 module for more information.

CONTRASTE

SPECIFICATION SHEET

Ardito LED - A3SAR

3-1/2" Series

Ultra-Thin Profile Square Adjustable Regressed Trim

SPECIFICATIONS (CONT'D)

COMPATIBLE HOUSINGS

	Remodel Housing	New Construction Housing	Insulated Housing	Insulated Air Tight Housing (Title 24)	Ceiling thickness suggested for insulated housing as a using standard and Lumenetix option
Performance 1 (14W)	REA3V1	NWA3SV1	*ISA3SV1	*ICAT6S3-ARV1	* Ceiling thickness must be at least 1/4" (6.4 mm) for insulated housing as a using standard.
Performance 2 (23W)	REA3V2	NWA3SV2	*ISA3SV2	*ICAT6S3-ARV2	
Lumenetix (12.5W)	REA3VL	NWA3SVL	**ISA3SVL		** Ceiling thickness must be at least 3/4" (19 mm) for insulated housing with Lumenetix option.

For dimming, please visit our Web site frequently to find our suggested compatible dimmers: www.contrastlighting.com

OPTIC SYSTEM

Interchangeable optional optical reflectors and lenses available to customize your lighting.

Choice of available lenses:

Stackable (up to 2) (also sold separately)

Clear (C)

Frosted (F)

Honeycomb (H): the honeycomb louver reduces glare

Linear (L): the linear lens directs the lamp beam to create a strip of light

Prismatic (P): the prismatic lens diffuses and spreads the light in an even overall pattern

Solite (S): the solite lens softens the light in an even overall pattern

Optical reflectors available: Spot, Narrow Flood, Flood

	Standard	Lumenetix
Spot (S)	15°	Not available
Narrow Flood (M)	32°	33°
Flood (L)	40°	44°

* Average beams shown. Consult .ies files on our Website for more details.

FLANGE FINISHES

Powder coat painted or plated aluminum.

Different finishes available:

24K Gold Plated **(-03)**, Chrome **(-04)**, Brushed Chrome **(-04BR)**, Matte White **(-11)**, Brushed Nickel **(-12BR)**, Satin Nickel **(-13)** and Matte Black **(-22)**

REFLECTOR FINISHES

Painted

Matte White **(11)**

Matte black **(22)**

Natural Anodized Aluminum **(AN)**

Black **(BK)**

FLANGELESS TRIMS (OPTION)

Perforated aluminum plate for flangeless product, allowing you to plaster up to the edge of the opening of the Ardito luminaire.

Mud-in-plate sold separately.

Ordering code: MIPA3S

Consult housing specification sheet for more details.

CONTRASTE2018-03
Revision 1

PRINTED IN CANADA

1009, rue du Parc Industriel
Lévis (Québec) G6Z 1C5 Canada
Tel.: 1-888-839-4624
Fax.: 1-877-839-7057
contrastlighting.com
info@contrastlighting.com

© 2018 Contraste Lighting M.L. Inc.
All rights reserved

Contrast Lighting M.L. Inc. reserves the right to make changes in specifications and/or to discontinue any product at any time without notice or obligation and will not be liable for any consequences resulting from the use of this publication.

SPECIFICATION SHEET

Ardito LED - A3SAR

3-1/2" Series

Ultra-Thin Profile Square Adjustable Regressed Trim



TRIM WITH FLANGE CODIFICATION EXAMPLE

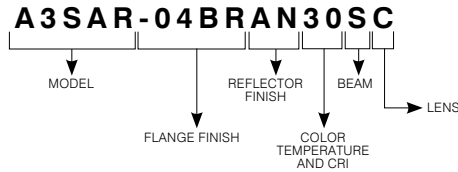

TRIM WITH FLANGE ORDERING CODES **A3SAR**

MODEL	FLANGE FINISHES	REFLECTOR FINISHES	COLOR TEMPERATURES AND CRI	BEAMS	LENSES
A3SAR					
A3SAR	-03 24K Gold Plated	PAINTED	27 2,700K (90+ CRI)	S Spot (15°) (not available with CT and WD) M Narrow Flood (32°) L Flood (40°)	C Clear
	-04 Chrome	11 Matte White	30 3,000K (90+ CRI)		F Frosted
	-04BR Brushed Chrome	22 Matte Black	35 3,500K (90+ CRI)		H Honeycomb
	-11 Matte White	AN Natural Anodized Aluminum	40 4,000K (90+ CRI)		L Linear
	-12BR Brushed Nickel		CT 1,650K to 4,000K (90+ CRI)		P Prismatic
	-13 Satin Nickel	BK Black	WD 3,050K to 1,800K (90+ CRI)		S Solite
	-22 Matte Black				

FLANGELESS TRIM OPTION — CODIFICATION EXAMPLE

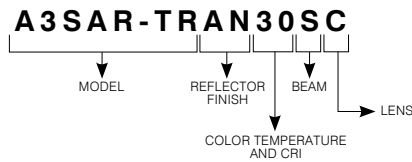

Mud-in-plate required for use of flangeless trim (see ordering code on next page)

FLANGELESS TRIM OPTION — ORDERING CODES **A3SAR-TR**

MODEL	REFLECTOR FINISHES	COLOR TEMPERATURES AND CRI	BEAMS	LENSES
A3SAR-TR				
A3SAR-TR	PAINTED	27 2,700K (90+ CRI)	S Spot (15°) (not available with CT and WD) M Narrow Flood (32°) L Flood (40°)	C Clear
	11 Matte White	30 3,000K (90+ CRI)		F Frosted
	22 Matte Black	35 3,500K (90+ CRI)		H Honeycomb
	AN Natural Anodized Aluminum	40 4,000K (90+ CRI)		L Linear
	BK Black	CT 1,650K to 4,000K (90+ CRI)		P Prismatic
		WD 3,050K to 1,800K (90+ CRI)		S Solite

SPECIFICATION SHEET

Ardito LED - A3SAR**3-1/2" Series****Ultra-Thin Profile Square Adjustable Regressed Trim****MUD-IN-PLATE**

Required with the use of flangeless trims.
Consult housing specification sheet for more details.

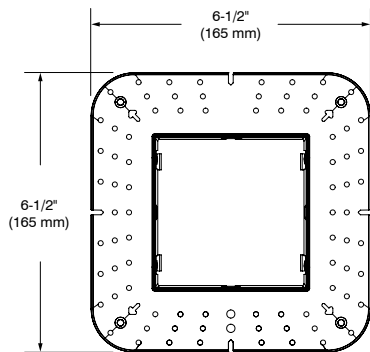
**3-3/4" (95 mm) x 3-3/4" (95 mm)****Code: MIPA3S****REUSABLE TEMPLATE OPTION**

Reusable steel cutout template
for square trim.

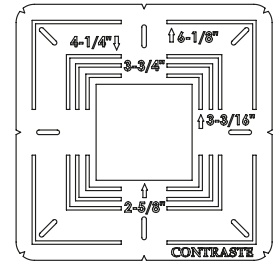
Code: TEMP-SQ**ORDERING CODES****for replacement lenses and reflectors**

For future on-site modifications of the light distribution.

Lenses (to modify light diffusion)**Stackable (up to 2)**Clear (C): **104036**Frosted (F): **317240**Linear (L): **104037**Solite (S): **104038**Prismatic (P): **104039**Honeycomb (H): **104040****Reflectors (to modify the beam angle)**For a Spot: **103942**For a Narrow Flood: **103912**For a Flood: **103943****CONTRASTE**2018-03
Revision 1

PRINTED IN CANADA

1009, rue du Parc Industriel
Lévis (Québec) G6Z 1C5 Canada
Tel.: 1-888-839-4624
Fax.: 1-877-839-7057
contrastelighting.com
info@contrastelighting.com

© 2018 Contraste Lighting M.L. Inc.
All rights reserved

Contrast Lighting M.L. Inc. reserves the right to make changes in specifications and/or to discontinue any product at any time without notice or obligation and will not be liable for any consequences resulting from the use of this publication.

Ardito LED - A3SAR

3-1/2" Series

Ultra-Thin Profile Square Adjustable Regressed Trim

PHOTOMETRIC DATA



In order to obtain the accurate photometric data, multiply the lumens relative to your product selection by the applicable factor(s). Take note these factors also need to be implemented in the .ies files available on our website.

WITH PERFORMANCE 1 HOUSING (14W)

	Spot (15°)		Narrow Flood (32°)		Flood (40°)	
	lm	lm/W	lm	lm/W	lm	lm/W
2,700K with 90+ CRI	1,309	93.5	1,249	89.2	1,214	86.7
3,000K with 90+ CRI	1,356	96.9	1,294	92.4	1,258	89.9
3,500K with 90+ CRI	1,422	101.6	1,356	96.9	1,319	94.2
4,000K with 90+ CRI	1,458	104.1	1,391	99.4	1,353	96.6



WITH PERFORMANCE 2 HOUSING (23W)

	Spot (15°)		Narrow Flood (32°)		Flood (40°)	
	lm	lm/W	lm	lm/W	lm	lm/W
2,700K with 90+ CRI	1,856	80.7	1,804	78.4	1,812	78.8
3,000K with 90+ CRI	1,923	83.6	1,869	81.3	1,878	81.7
3,500K with 90+ CRI	2,016	87.7	1,960	85.2	1,969	85.6
4,000K with 90+ CRI	2,068	89.9	2,010	87.4	2,019	87.8



WITH PERFORMANCE L HOUSING (12.5W)

	Narrow Flood (33°)		Flood (44°)	
	lm	lm/W	lm	lm/W
Warm Dimming (WD) with 90+ CRI	668	53.4	649	51.9
Color Tuning (CT) with 90+ CRI	700	56	680	54.4

Lens Factors	
C	1
F	0.71
H	0.57

CONTRASTE

2018-03
Revision 1

PRINTED IN CANADA

1009, rue du Parc Industriel
Lévis (Québec) G6Z 1C5 Canada
Tel.: 1-888-839-4624
Fax.: 1-877-839-7057
contrastlighting.com
info@contrastlighting.com

© 2018 Contraste Lighting M.L. Inc.
All rights reserved

Contrast Lighting M.L. Inc. reserves the right to make changes in specifications and/or to discontinue any product at any time without notice or obligation and will not be liable for any consequences resulting from the use of this publication.

Ardito LED - A3SAR

3-1/2" Series

Ultra-Thin Profile Square Adjustable Regressed Trim

PHOTOMETRIC DATA



3,000K, 90+ CRI, Spot, Performance 1

CANDLEPOWER DISTRIBUTION

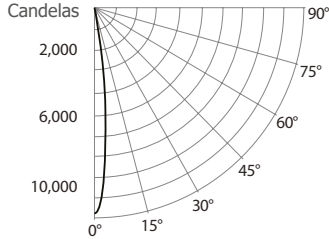

LIGHT CONE

Distance	FC	DIA
06'	326.5	1.6'
08'	183.6	2.1'
10'	117.5	2.6'
12'	81.6	3.2'
14'	59.9	3.7'
16'	45.9	4.2'

Beam: 15°
Beam Edge defined as 50% of Maximum Nadir Candle-power.

LUMINAIRE

Performance 1 LED	3,000K	Spot
CBCP / Lumens	11,753	1,356.2
Watts	120V	277V
	14W	14.5W
Operating AMPS	0.12A	0.052A
Lumen Maintenance	L70 @ 50,000 Hrs	
CRI	90+	
Lumens/Watt	96.9	
Spacing Criteria	0.26	

COEFFICIENT OF UTILIZATION - %

Ceiling Reflect %	80			50			30			
Wall Reflect %	50	30	50	30	50	30	50	30	50	30
RCR	0	119	119	111	111	106	106	106	106	106
	2	109	106	104	102	101	99	99	99	99
	4	101	97	98	95	96	94	94	94	94
	6	95	91	93	90	92	89	89	89	89
	8	90	86	89	86	88	85	85	85	85
	10	86	82	85	82	84	81	81	81	81

Zonal Cavity Method
Effective Floor Cavity Reflectance 20%

ZONAL LUMEN SUMMARY

ZONE	LUMENS	%LUMINAIRE
0-30	1,327.6	97.9%
0-40	1,356.1	100%
0-60	1,356.2	100%
60-90	0.0	0%
0-90	1,356.2	100%

MULTIPLE UNIT DATA - (RCR 2)

SPACING ON CENTER	INITIAL FOOTCANDLES	WATTS/SQ. FT.
5'	69	0.59
6'	39	0.33
7'	27	0.23
8'	27	0.23
9'	17	0.15

38' x 38' x 10' Room. Workplan located 2-1/2' (30").
Reflectance factor 80%/50%/30%

CANDELAS DISTRIBUTION

DEGREES/VERTICAL	CANDELAS	DEGREES/VERTICAL	CANDELAS
0	11,753	40	0
5	8,353	50	0
10	3,936	60	0
15	1,524	70	0
20	836	80	0
25	490	90	0
30	204		

3,000K, 90+ CRI, Narrow Flood, Performance 1

CANDLEPOWER DISTRIBUTION

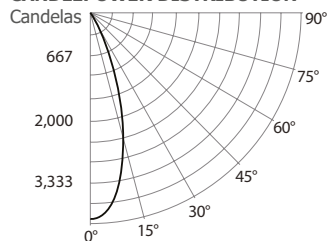

LIGHT CONE

Distance	FC	DIA
06'	109.4	3.4'
08'	61.6	4.6'
10'	39.4	5.7'
12'	27.4	6.9'
14'	20.1	8.0'
16'	15.4	9.2'

Beam: 32°
Beam Edge defined as 50% of Maximum Nadir Candle-power.

LUMINAIRE

Performance 1 LED	3,000K	Narrow Flood
CBCP / Lumens	3,940	1,294.3
Watts	120V	277V
	14W	14.5W
Operating AMPS	0.12A	0.052A
Lumen Maintenance	L70 @ 50,000 Hrs	
CRI	90+	
Lumens/Watt	92.5	
Spacing Criteria	0.55	

COEFFICIENT OF UTILIZATION - %

Ceiling Reflect %	80			50			30			
Wall Reflect %	50	30	50	30	50	30	50	30	50	30
RCR	0	119	119	111	111	106	106	106	106	106
	2	107	104	102	100	99	97	97	97	97
	4	97	93	94	91	93	90	90	90	90
	6	90	85	88	84	86	83	83	83	83
	8	83	79	82	78	81	78	78	78	78
	10	78	73	77	73	76	72	72	72	72

Zonal Cavity Method
Effective Floor Cavity Reflectance 20%

ZONAL LUMEN SUMMARY

ZONE	LUMENS	%LUMINAIRE
0-30	1,236.5	95.5%
0-40	1,294.2	100%
0-60	1,294.3	100%
60-90	0.0	0%
0-90	1,294.3	100%

MULTIPLE UNIT DATA - (RCR 2)

SPACING ON CENTER	INITIAL FOOTCANDLES	WATTS/SQ. FT.
5'	65	0.59
6'	36	0.33
7'	25	0.23
8'	25	0.23
9'	16	0.15

38' x 38' x 10' Room. Workplan located 2-1/2' (30").
Reflectance factor 80%/50%/30%

CANDELAS DISTRIBUTION

DEGREES/VERTICAL	CANDELAS	DEGREES/VERTICAL	CANDELAS
0	3,940	40	2
5	3,712	50	0
10	3,055	60	0
15	2,111	70	0
20	1,232	80	0
25	644	90	0
30	293		

SPECIFICATION SHEET

Ardito LED - A3SAR

3-1/2" Series

Ultra-Thin Profile Square Adjustable Regressed Trim

PHOTOMETRIC DATA



3,000K, 90+ CRI, Flood, Performance 1

CANDLEPOWER DISTRIBUTION

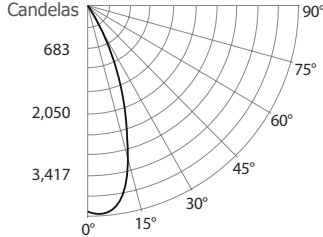

LIGHT CONE

Distance	FC	DIA
06'	74.8	4.3'
08'	42.1	5.7'
10'	26.9	7.1'
12'	18.7	8.5'
14'	13.7	10.0'
16'	10.5	11.4'

Beam: 40°
Beam Edge defined as 50% of Maximum Nadir Candle-power.

LUMINAIRE

Performance 1 LED	3,000K Flood	
CBCP / Lumens	2,692 / 1,257.3	
Watts	120V	277V
	14W	14.5W
Operating AMPS	0.12A	0.052A
Lumen Maintenance	L70 @ 50,000 Hrs	
CRI	90+	
Lumens/Watt	89.9	
Spacing Criteria	0.68	

COEFFICIENT OF UTILIZATION - %

Ceiling Reflect %	80		50		30		
Wall Reflect %	50	30	50	30	50	30	
RCR	0	119	119	111	111	106	106
	2	106	103	101	99	98	96
	4	96	91	93	89	91	88
	6	87	82	85	81	84	80
	8	80	75	78	74	78	74
	10	74	69	73	69	72	68

Zonal Cavity Method
Effective Floor Cavity Reflectance 20%

ZONAL LUMEN SUMMARY

ZONE	LUMENS	%LUMINAIRE
0-30	1,170.6	93.1%
0-40	1,255.4	99.9%
0-60	1,257.3	100%
60-90	0.0	0%
0-90	1,257.3	100%

MULTIPLE UNIT DATA - (RCR 2)

SPACING ON CENTER	INITIAL FOOTCANDLES	WATTS/ SQ. FT.
5'	62	0.58
6'	35	0.33
7'	24	0.23
8'	24	0.23
9'	16	0.15

38' x 38' x 10' Room. Workplan located 2-1/2' (30").
Reflectance factor 80%/50%/30%

CANDELAS DISTRIBUTION

DEGREES/ VERTICAL	CANDELAS	DEGREES/ VERTICAL	CANDELAS
0	2,692	40	11
5	2,715	50	0
10	2,508	60	0
15	1,952	70	0
20	1,329	80	0
25	847	90	0
30	391		

3,000K, 90+ CRI, Spot, Performance 2

CANDLEPOWER DISTRIBUTION

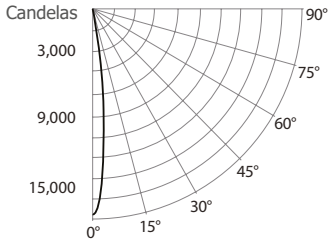

LIGHT CONE

Distance	FC	DIA
06'	478.9	1.5'
08'	269.4	2.1'
10'	172.4	2.6'
12'	119.7	3.1'
14'	87.9	3.6'
16'	67.3	4.1'

Beam: 15°
Beam Edge defined as 50% of Maximum Nadir Candle-power.

LUMINAIRE

Performance 2 LED	3,000K Spot	
CBCP / Lumens	17,240 / 1,923	
Watts	120V	277V
	23W	23.5W
Operating AMPS	0.19A	0.085A
Lumen Maintenance	L70 @ 50,000 Hrs	
CRI	90+	
Lumens/Watt	83.6	
Spacing Criteria	0.26	

COEFFICIENT OF UTILIZATION - %

Ceiling Reflect %	80		50		30		
Wall Reflect %	50	30	50	30	50	30	
RCR	0	121	121	113	113	108	108
	2	110	107	105	103	103	101
	4	103	99	100	97	98	95
	6	96	93	94	91	93	91
	8	91	88	90	87	89	86
	10	87	84	86	83	86	83

Zonal Cavity Method
Effective Floor Cavity Reflectance 20%

ZONAL LUMEN SUMMARY

ZONE	LUMENS	%LUMINAIRE
0-30	1,883.2	97.9%
0-40	1,922.6	100%
0-60	1,923.0	100%
60-90	0.0	0%
0-90	1,923.0	100%

MULTIPLE UNIT DATA - (RCR 2)

SPACING ON CENTER	INITIAL FOOTCANDLES	WATTS/ SQ. FT.
5'	97	1.02
6'	55	0.57
7'	38	0.4
8'	38	0.4
9'	24	0.25

38' x 38' x 10' Room. Workplan located 2-1/2' (30").
Reflectance factor 80%/50%/30%

CANDELAS DISTRIBUTION

DEGREES/ VERTICAL	CANDELAS	DEGREES/ VERTICAL	CANDELAS
0	17,240	40	1
5	12,102	50	0
10	5,541	60	0
15	2,109	70	0
20	1,173	80	0
25	699	90	0
30	278		

Ardito LED - A3SAR

3-1/2" Series

Ultra-Thin Profile Square Adjustable Regressed Trim

PHOTOMETRIC DATA



3,000K, 90+ CRI, Narrow Flood, Performance 2

CANDLEPOWER DISTRIBUTION

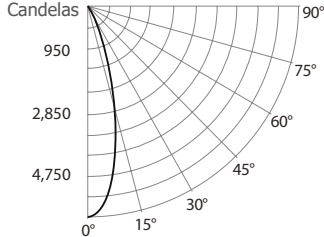

LIGHT CONE

Distance	FC	DIA
06'	158.3	3.4'
08'	89.04	4.6'
10'	56.9	5.7'
12'	39.6	6.9'
14'	29.1	8.0'
16'	22.3	9.2'

Beam: 32°
Beam Edge defined as 50% of Maximum Nadir Candle-power.

LUMINAIRE

Performance 2 LED	3,000K	Narrow Flood
CBCP / Lumens	5,699	/ 1,868.7
Watts	120V	277V
	23W	23.5W
Operating AMPS	0.19A	0.085A
Lumen Maintenance	L70 @ 50,000 Hrs	
CRI	90+	
Lumens/Watt	81.2	
Spacing Criteria	0.55	

COEFFICIENT OF UTILIZATION - %

Ceiling Reflect %	80		50		30		
Wall Reflect %	50	30	50	30	50	30	
RCR	0	119	119	111	111	106	106
	2	107	104	102	100	99	97
	4	97	93	94	91	93	90
	6	90	85	88	84	86	83
	8	83	79	82	78	81	78
	10	78	73	77	73	76	72

Zonal Cavity Method
Effective Floor Cavity Reflectance 20%

ZONAL LUMEN SUMMARY

ZONE	LUMENS	%LUMINAIRE
0-30	1,785.1	95.5%
0-40	1,868.5	100%
0-60	1,868.7	100%
60-90	0.0	0%
0-90	1,868.7	100%

MULTIPLE UNIT DATA - (RCR 2)

SPACING ON CENTER	INITIAL FOOTCANDLES	WATTS/SQ. FT.
5'	93	1.01
6'	52	0.57
7'	36	0.39
8'	36	0.39
9'	23	0.25

38' x 38' x 10' Room. Workplan located 2-1/2' (30").
Reflectance factor 80%/50%/30%

CANDELAS DISTRIBUTION

DEGREES/VERTICAL	CANDELAS	DEGREES/VERTICAL	CANDELAS
0	5,699	40	2
5	5,377	50	0
10	4,410	60	0
15	3,039	70	0
20	1,777	80	0
25	931	90	0
30	407		

3,000K, 90+ CRI, Flood, Performance 2

CANDLEPOWER DISTRIBUTION

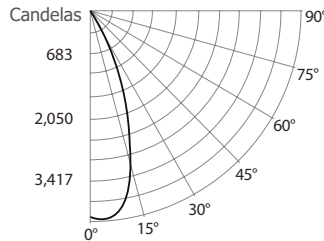

LIGHT CONE

Distance	FC	DIA
06'	111.5	4.2'
08'	62.7	5.7'
10'	40.1	7.1'
12'	27.9	8.5'
14'	20.5	9.9'
16'	15.7	11.3'

Beam: 40°
Beam Edge defined as 50% of Maximum Nadir Candle-power.

LUMINAIRE

Performance 2 LED	3,000K	Flood
CBCP / Lumens	4,012	/ 1,878.2
Watts	120V	277V
	23W	23.5W
Operating AMPS	0.19A	0.085A
Lumen Maintenance	L70 @ 50,000 Hrs	
CRI	90+	
Lumens/Watt	81.7	
Spacing Criteria	0.98	

COEFFICIENT OF UTILIZATION - %

Ceiling Reflect %	80		50		30		
Wall Reflect %	50	30	50	30	50	30	
RCR	0	119	119	111	111	106	106
	2	106	103	101	99	98	96
	4	96	91	93	89	91	88
	6	87	82	85	81	84	80
	8	80	75	78	74	78	74
	10	74	69	73	69	72	68

Zonal Cavity Method
Effective Floor Cavity Reflectance 20%

ZONAL LUMEN SUMMARY

ZONE	LUMENS	%LUMINAIRE
0-30	1,747.1	93%
0-40	1,875.4	99.8%
0-60	1,878.2	100%
60-90	0.0	0%
0-90	1,878.2	100%

MULTIPLE UNIT DATA - (RCR 2)

SPACING ON CENTER	INITIAL FOOTCANDLES	WATTS/SQ. FT.
5'	93	1.01
6'	52	0.57
7'	36	0.39
8'	36	0.39
9'	23	0.25

38' x 38' x 10' Room. Workplan located 2-1/2' (30").
Reflectance factor 80%/50%/30%

CANDELAS DISTRIBUTION

DEGREES/VERTICAL	CANDELAS	DEGREES/VERTICAL	CANDELAS
0	4,012	40	19
5	4,053	50	0
10	3,761	60	0
15	2,915	70	0
20	1,974	80	0
25	1,268	90	0
30	582		