



# DUPLO S1180 0-10V 110V

ver. 20200404\_Rev\_0

year: **2018**  
code: **2360312A20000**  
type: **hanging lamp**  
application: **indoor**

## Available variants

### Colour temperature

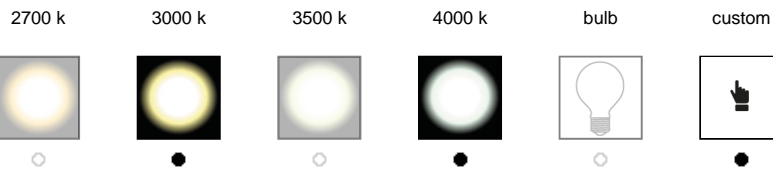

### Colour rendering index

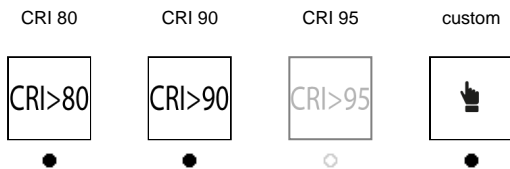

### Structure finish

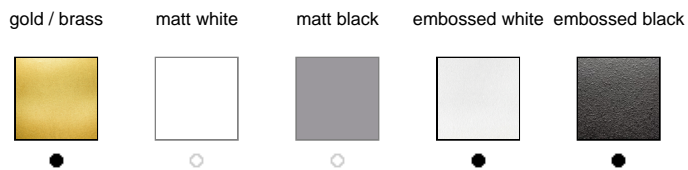

### Diffuser / Optical

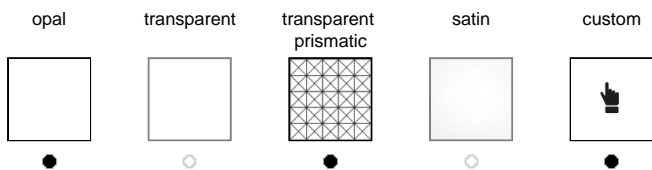

### Ceiling Mount

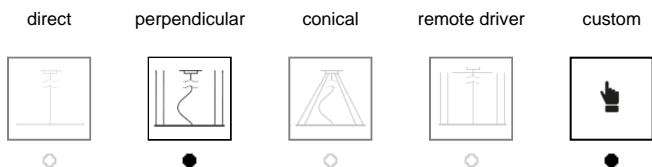

# DUPLO S1980 0-10V 110V

ver. 20200404\_Rev\_0

year: 2018  
code: 2360320A20000  
type: hanging lamp  
application: indoor

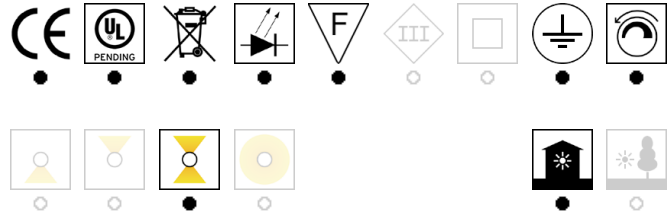

**Technical drawing**  
Size ref. image mm - inch

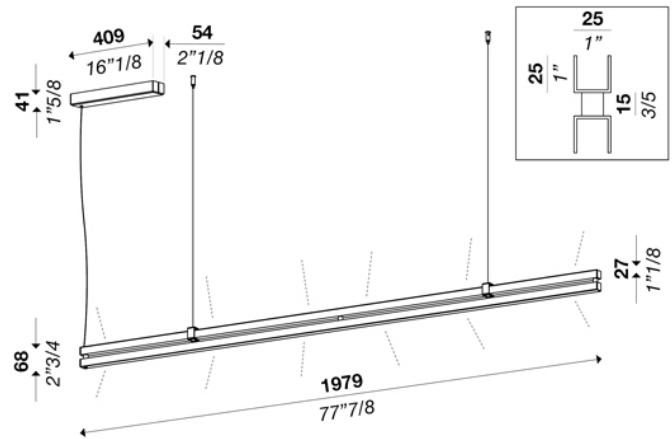

**Technical data**

Light source	LED
Circuit structure	LED strip
Light emission direction	direct and indirect
Power	72 W
Source lumens	9761 lm
Source efficacy	137 lm/W
Consumption	77 W
Delivered lumens	3781 lm
Luminaire efficacy	49 lm/W
Secondary	24 V
Colour temperature	3000 K / variants page 2
Colour rendering index	80 CRI / variants page 2
Standard Deviation of Colour Matching	3 SDCM
Energy class	A
Safety class	I
Degree of protection	IP 20
Direct mounting on normally flammable surfaces	●
Operating temperature	+10° / +40°
CE	●
UL	○
<b>Optional</b>	
Emergency mode	○
Motion sensor	○
Directional	○

**Packing**

Net weight	
Packaging 1	
Packaging 2	
Packaging 3	
Packaging 4	
Packaging 5	

**Structure**

Material	aluminium
Finish	embossed white / variants page 2

**Diffuser**

Material	polycarbonate
Finish	opal / variants page 2

**Canopy**

Size	307 x 92 mm - 12" 1/8 x 3" 5/8 inch
Height	45 mm - 1" 3/4 inch
Ceiling mount	perpendicular / variants page 2

**Electronics / Driver**

Included	Yes
Quantity	1
Voltage	100-277V 50/60 Hz

**Dimmable**



**Hanging cables**

Stainless steel cables standard length (custom available)	2000 mm / 78" 3/4
Electric cable standard length (custom available)	2500 mm/100"

**Warranty**

Duration	2 years
----------	---------

# DUPLO S1980 0-10V 110V

ver. 20200404\_Rev\_0

year: **2018**  
code: **2360320A20000**  
type: **hanging lamp**  
application: **indoor**

## Available variants

### Colour temperature

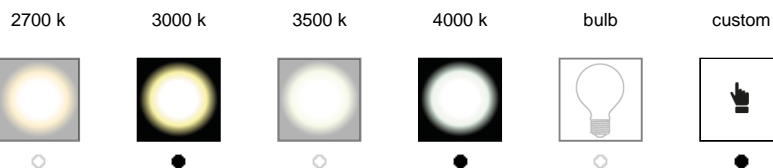

### Colour rendering index

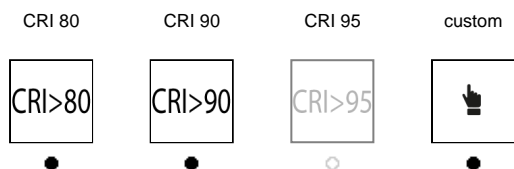

### Structure finish

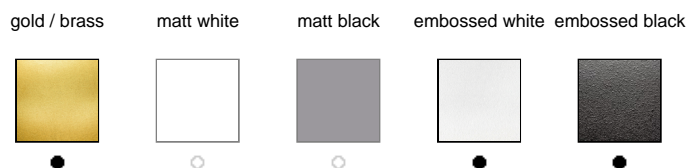

### Diffuser / Optical

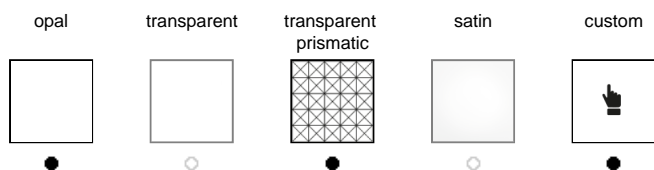

### Ceiling Mount

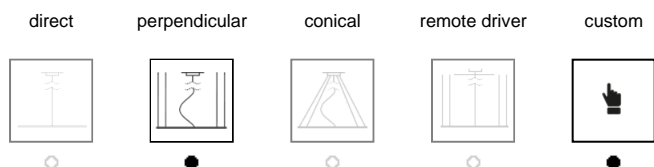

# DUPLO S2875 0-10V 110V

ver. 20200404\_Rev\_0

year: 2018  
code: 2360328A20000  
type: hanging lamp  
application: indoor

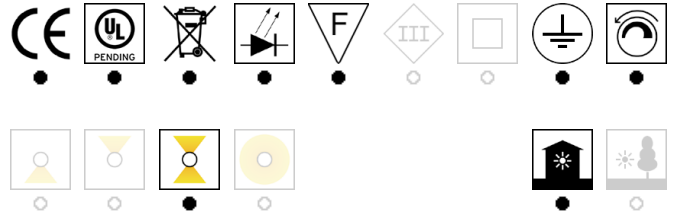

**Technical drawing**  
Size ref. image mm - inch

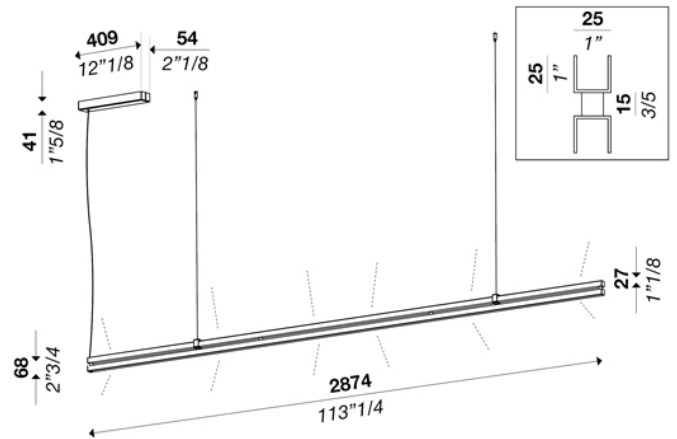

**Technical data**

Light source	LED
Circuit structure	LED strip
Light emission direction	direct and indirect
Power	103 W
Source lumens	14100 lm
Source efficacy	137 lm/W
Consumption	110 W
Delivered lumens	5399 lm
Luminaire efficacy	49 lm/W
Secondary	24 V
Colour temperature	3000 K / variants page 2
Colour rendering index	80 CRI / variants page 2
Standard Deviation of Colour Matching	3 SDCM
Energy class	A
Safety class	I
Degree of protection	IP 20
Direct mounting on normally flammable surfaces	●
Operating temperature	+10° / +40°
CE	●
UL	○

**Optional**

Emergency mode	○
Motion sensor	○
Directional	○

**Packing**

Net weight	
Packaging 1	
Packaging 2	
Packaging 3	
Packaging 4	
Packaging 5	

**Structure**

Material	aluminium
Finish	embossed white / variants page 2

**Diffuser**

Material	polycarbonate
Finish	opal / variants page 2

**Canopy**

Size	307 x 92 mm - 12" 1/8 x 3" 5/8 inch
Height	45 mm - 1" 3/4 inch
Ceiling mount	perpendicular / variants page 2

**Electronics / Driver**

Included	Yes
Quantity	1
Voltage	100-277V 50/60 Hz

**Dimmable**



**Hanging cables**

Stainless steel cables standard length (custom available)	2000 mm / 78" 3/4
Electric cable standard length (custom available)	2500 mm/100"

**Warranty**

Duration	2 years
----------	---------

# DUPLO S2875 0-10V 110V

ver. 20200404\_Rev\_0

year: **2018**  
code: **2360328A20000**  
type: **hanging lamp**  
application: **indoor**

## Available variants

### Colour temperature

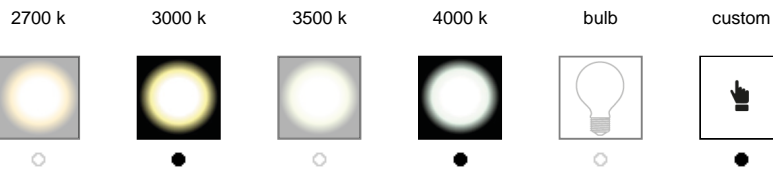

### Colour rendering index

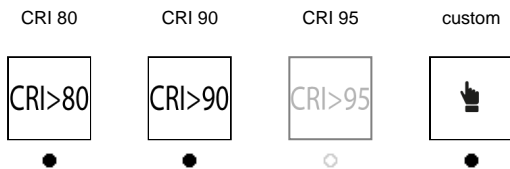

### Structure finish

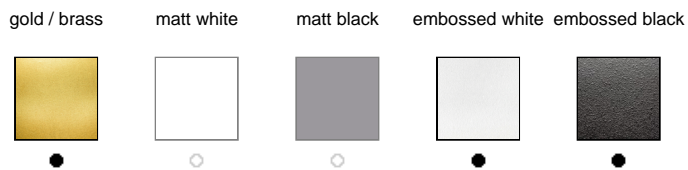

### Diffuser / Optical

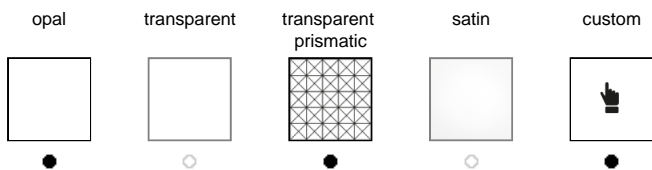

### Ceiling Mount

