

Feed-Through Power Stem

4.6" Round Canopy

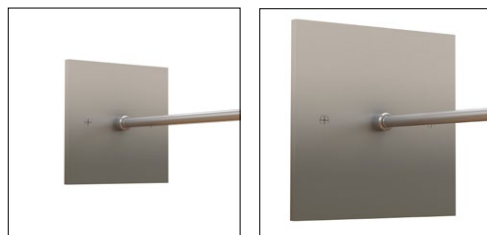

2.8" Square Canopy

4.6" Square Canopy

**Description:**

Kurve Display Sign features a lambertian white diffuser that provides uniform light without hotspots. At 7.5 watts per foot, the 24 volt DC channel contains 85+ or 95+ CRI LEDs and mounts 14 inches from wall. It may be ordered with a 4.6 inch round or square canopy that fits on a standard 4 inch square electrical box with round plaster ring; a 2.8 inch square canopy, or a special feed-thru stem for floating signs. Hinges on the fixture arm rotates up to 90 degrees (from facing the wall to straight down). Kurve is powered by a Class 2 remote power supply up to 40 feet away. Available from 12 inches to 120 inches/10 feet (Chrome max at 84 inches). May be ordered in 3, 5, 8 or 10 inch increments. Fixtures include a 5 year warranty.

**Finish:**

Satin Nickel, Chrome, Antique Bronze, Satin Aluminum, White or Satin Black  
Custom finishes available

**Applications:**

Wall wash and retail stores

**Lamp:** 50,000 Hour Lamp Life

Version	Watts per Foot	Lumens		85+ CRI 22K, 35K, 40K, 57K	95+ CRI 27K, 30K
		per Watt	per Foot		
<b>7WDC</b>	7.5	36	270	●	●

Lumen values are based on the 3000K LED test.

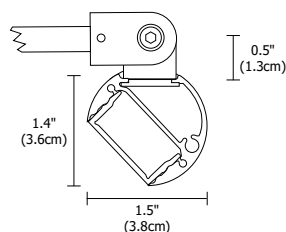
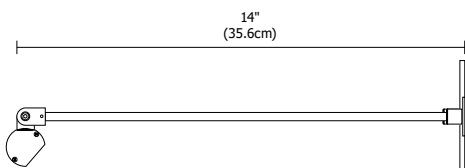

**Remote Power Supplies\* & Dimmers (Sold Separately):**

- Electronic Low Voltage Dimming (ELV)
- 0-10 Volt Dimming (0-10V)
- Lutron Hi-lume®

System	Wattage/Voltage	Canopy	Nominal Size	Color Temperature	Finish
<b>KD</b>	<b>7WDC</b>	<b>4RD</b>	<b>120IN</b>	<b>27K</b>	<b>SN</b>
<b>KD</b> Kurve Display	<b>7WDC</b> 7.5 Watt 24 Volt DC	<b>2SQ</b> 2.8" Square <b>4RD</b> 4.6" Round <b>4SQ</b> 4.6" Square <b>FTP</b> Feed-Through Power Stem	<b>12-120</b> Order in 12 inch increments up to 120 inches May be ordered in 3, 5, 8 or 10 inch increments Chrome Max 84"	<b>22K</b> 2200K Amber White <b>27K</b> 2700K Very Warm White <b>30K</b> 3000K Warm White <b>35K</b> 3500K Neutral White <b>40K</b> 4000K Cool White <b>57K</b> 5700K Daylight White	<b>SN</b> Satin Nickel <b>CH</b> Chrome (Max 84") <b>BZ</b> Antique Bronze <b>SA</b> Satin Aluminum <b>BK</b> Satin Black <b>WH</b> White

**Application:** 0-10V dimming for Kurve Display Sign

**Power Supply:** Class 2, 24VDC output: 120VAC input, PSB-25W-010-24VDC;  
120-277VAC input, PSB-96W-010-24VDC; PSB-2X96W-010-24VDC

**Dimming:** Dimmable with 0-10V dimmer using power supplies above: Philips Sunrise SR1200ZTUNV,  
0-10V dimmer recommended.

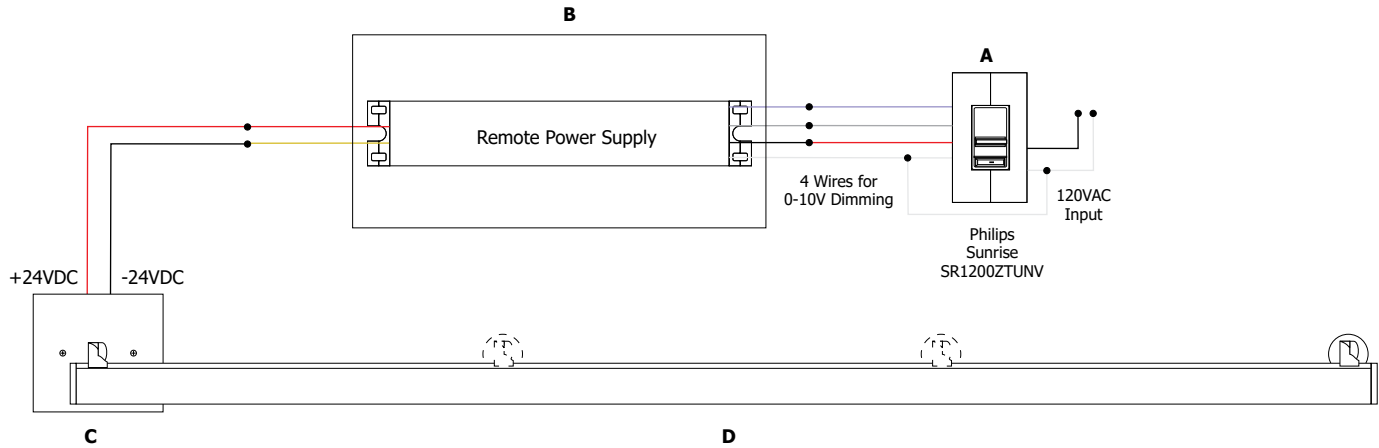

- A. Philips Sunrise 0-10V Dimmer **SR1200ZTUNV**
- B. 96W 24VDC Power Supply **PSB-96W-010-24VDC**
- C. 4.6" Square Canopy
- D. Kurve Display Sign **KD-7WDC-4SQ-\_-\_-**



Satin Aluminum  
**SA**



Satin Nickel  
**SN**



Antique Bronze  
**BZ**



Satin Black  
**BK**



Chrome  
**CH**



White  
**WH**

**Fixture Mounted 14 inches from wall**

	[Image of fixture]					
1'	91	91	91	91	91	91
2'	52	52	52	52	52	52
3'	28	28	28	28	28	28
4'	22	22	22	22	22	22
5'	14	14	14	14	14	14
6'	11	11	11	11	11	11
7'	9	9	9	9	9	9
8'	5	5	5	5	5	5

PROJECT:

FIXTURE  
TYPE:

DATE:



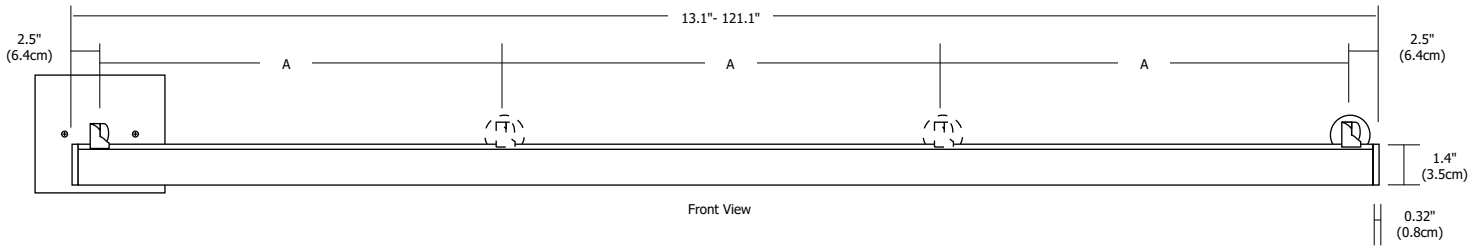

**KURVE DISPLAY SIGN ACTUAL LENGTH**

ORDERING CODE (NOMINAL SIZE)	LENGTH (INCHES)	STEM QUANTITY	STEM SPACING (A)
12IN	13.1	2	8.1
15IN	15.5	2	10.5
17IN	17.9	2	12.9
20IN	20.3	2	15.3
22IN	22.7	2	17.7
24IN	25.1	2	20.1
27IN	27.5	2	22.5
29IN	29.9	2	24.9
32IN	32.3	2	27.3
34IN	34.7	2	29.7
36IN	37.1	2	32.1
39IN	39.5	2	34.5
41IN	41.9	2	36.9
44IN	44.3	2	39.3
46IN	46.7	2	41.7
48IN	49.1	2	44.1
51IN	51.5	3	23.25
53IN	53.9	3	24.45
56IN	56.3	3	25.65
58IN	58.7	3	26.85
60IN	61.1	3	28.05
63IN	63.5	3	29.25
65IN	65.9	3	30.45
68IN	68.3	3	31.65
70IN	70.7	3	32.85
72IN	73.1	3	34.05
75IN	75.5	3	35.25
77IN	77.9	3	36.45
80IN	80.3	3	37.65
82IN	82.7	3	38.85
84IN	85.1	3	40.05
87IN	87.5	3	41.25
89IN	89.9	3	42.45
92IN	92.3	3	43.65
94IN	94.7	3	44.85
96IN	97.1	3	46.05
99IN	99.5	4	31.5
101IN	101.9	4	32.3
104IN	104.3	4	33.1
106IN	106.7	4	33.9
108IN	109.1	4	34.7
111IN	111.5	4	35.5
113IN	113.9	4	36.3
116IN	116.3	4	37.1
118IN	118.7	4	37.9
120IN	121.1	4	38.7

PROJECT: \_\_\_\_\_ FIXTURE TYPE: \_\_\_\_\_ DATE: \_\_\_\_\_



**REQUIRED COMPONENTS:** 24VDC ELV Compatible Power Supplies.

ELECTRONIC LOW-VOLTAGE (ELV) POWER SUPPLIES & RECOMMENDED DIMMERS <sup>†</sup>					
ORDERING CODES	PS-40W-ELV-24VDC	PS-60L-ELV-24VDC	PSB-60W-ELV-24VDC	PSB-2X60W-ELV-24VDC	PSB-100W-ELV-24VDC
SPECIFICATIONS					
MAXIMUM LOAD	40W (FITS IN JBOX)	60W (50W IN JBOX)	60W	2X60W	96W
INPUT VOLTAGE	120VAC	120VAC	120VAC	120VAC	120VAC
OUTPUT VOLTAGE	24VDC	24VDC	24VDC	24VDC	24VDC
DIMENSIONS	1.4" X 3" X 1"	2.25" X 1.25" X 0.83"	8.13" X 2" X 1.75"	12.15" X 6.48" X 2.18"	9.25" X 3.5" X 2"
CLASSIFICATION	CLASS 2	CLASS 2	CLASS 2	CLASS 2	CLASS 2
IN WALL MOUNTING	N/A	N/A	PSB-60W-ELV-24VDC-IW	PSB-2X60W-ELV-24VDC-IW	PSB-100W-ELV-24VDC-IW
DIMMING AND CONTROLS					
LUTRON DIVA: DVELV-300P	•	•	•	•	•
LUTRON SKYLARK: SELV-300P	•	•	•	•	•
LUTRON RADIO RA2: RRD-6NA	N/A	N/A	•	•	•
LUTRON MAESTRO: MAELV-600	•	•	•	•	•
LEGRAND ADORNE: ADTP-703TUM4	N/A	N/A	•	•	•

ELECTRONIC LOW-VOLTAGE (ELV) POWER SUPPLIES & RECOMMENDED DIMMERS <sup>†</sup>			
ORDERING CODES	PSB-2X100W-ELV-24VDC	PSB-3X100W-ELV-24VDC	PSB-4X100W-ELV-24VDC
SPECIFICATIONS			
MAXIMUM LOAD	2X96W	3X96W	4X96W
INPUT VOLTAGE	120VAC	120VAC	120VAC
OUTPUT VOLTAGE	24VDC	24VDC	24VDC
DIMENSIONS	12.15" X 6.48" X 2.18"	14" X 10" X 3"	17" X 13" X 3"
CLASSIFICATION	CLASS 2	CLASS 2	CLASS 2
IN WALL MOUNTING	PSB-2X100W-ELV-24VDC-IW	N/A	N/A
DIMMING AND CONTROLS			
LUTRON DIVA: DVELV-300P	•	•	•
LUTRON SKYLARK: SELV-300P	•	•	•
LUTRON RADIO RA2: RRD-6NA	•	•	•
LUTRON MAESTRO: MAELV-600	•	•	•
LEGRAND ADORNE: ADTP-703TUM4	•	•	•

<sup>†</sup>22K - 57K color temperatures are compatible with 0-10V, ELV, and Lutron Hi-lume® Power Supplies. Warm Dim (27D, 30D) color temperatures are only compatible with ELV power supplies. Tunable White (2K4K) color temperature is compatible with 0-10V, ELV, DMX, and Lutron Hi-lume® Power Supplies. Dynamic Color (RGB, RGB+W) and Static Color (Amber, Blue, Green, or Red) are compatible with DMX Power Supplies.

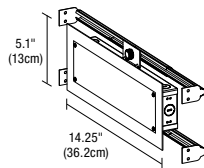

**5.1 x 14.25 inch In-Wall Mounting Kit:** Includes power supply, box cover and stud hangers for installing Junction Box in wall. Select "IW" in the options section of compatible power supply ordering codes if an In-Wall Mounting Kit is needed.

**Ordering Codes:** PSB-60W-ELV-24VDC-IW, PSB-100W-ELV-24VDC-IW

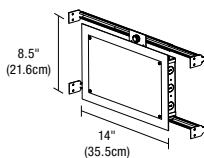

**8.5 x 14 inch In-Wall Mounting Kit:** Includes power supply, box cover and stud hangers for installing Junction Box in wall. Select "IW" in the options section of compatible power supply ordering codes if an In-Wall Mounting Kit is needed.

**Ordering Codes:** PSB-2x60W-ELV-24VDC-IW, PSB-2x100W-ELV-24VDC-IW

PROJECT:

FIXTURE  
TYPE:

DATE:



**REQUIRED COMPONENTS:** 24VDC 0-10V Compatible Power Supplies.

0-10 VOLT (010) POWER SUPPLIES & RECOMMENDED DIMMERS†				
ORDERING CODES	PSB-25W-010-24VDC	PSB-60W-010-24VDC	PSB-96W-010-24VDC	PSB-2X96W-010-24VDC
SPECIFICATIONS				
MAXIMUM LOAD	25W	60W	96W	2X96W
INPUT VOLTAGE	120VAC	120-277VAC	120-277VAC	120-277VAC
OUTPUT VOLTAGE	24VDC	24VDC	24VDC	24VDC
DIMENSIONS	12.4" X 3.12" X 2.18"	12.4" X 3.12" X 2.18"	12.4" X 3.12" X 2.18"	12.15" X 6.48" X 2.18"
CLASSIFICATION	CLASS 2	CLASS 2	CLASS 2	CLASS 2
IN WALL MOUNTING	PSB-25W-010-24VDC-IW	PSB-60W-010-24VDC-IW	PSB-96W-010-24VDC-IW	PSB-2X96W-010-24VDC-IW
DIMMING AND CONTROLS				
PHILIPS SUNRISE: SR1200ZTUNV	•	•	•	•
LUTRON DIVA: DVTW-WH	•	•	•	•
LUTRON NOVA T: NTSTV-DV-XX	•	•	•	•
LUTRON GRAFIX EYE QS: QSGRJ-XP	•	•	•	•
LUTRON RADIO RA2: RRD-10ND	•	•	•	•
LEVITON: LEV40050	•	•	•	•
LEVITON IP710-LFZ	•	•	•	•
LEGRAND: ADPD4FBL3P2W4	•	•	•	•

0-10 VOLT (010) POWER SUPPLIES & RECOMMENDED DIMMERS†		
ORDERING CODES	PSB-3X96W-010-24VDC	PSB-4X96W-010-24VDC
SPECIFICATIONS		
MAXIMUM LOAD	3X96W	4X96W
INPUT VOLTAGE	120-277VAC	120-277VAC
OUTPUT VOLTAGE	24VDC	24VDC
DIMENSIONS	14" X 10" X 3"	17" X 13" X 3"
CLASSIFICATION	CLASS 2	CLASS 2
IN WALL MOUNTING	N/A	N/A
DIMMING AND CONTROLS		
PHILIPS SUNRISE: SR1200ZTUNV	•	•
LUTRON DIVA: DVTW-WH	•	•
LUTRON NOVA T: NTSTV-DV-XX	•	•
LUTRON GRAFIX EYE QS: QSGRJ-XP	•	•
LUTRON RADIO RA2: RRD-10ND	•	•
LEVITON: LEV40050	•	•
LEVITON IP710-LFZ	•	•
LEGRAND: ADPD4FBL3P2W4	•	•

†22K - 57K color temperatures are compatible with 0-10V, ELV, and Lutron Hi-lume® Power Supplies. Warm Dim (27D, 30D) color temperatures are only compatible with ELV power supplies. Tunable White (2K4K) color temperature is compatible with 0-10V, ELV, DMX, and Lutron Hi-lume® Power Supplies. Dynamic Color (RGB, RGB+W) and Static Color (Amber, Blue, Green, or Red) are compatible with DMX Power Supplies.

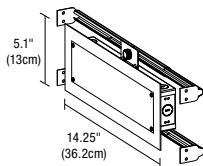

**5.1 x 14.25 inch In-Wall Mounting Kit:** Includes power supply, box cover and stud hangers for installing Junction Box in wall. Select "IW" in the options section of compatible power supply ordering codes if an In-Wall Mounting Kit is needed.

**Ordering Codes:** PSB-25W-010-24VDC-IW, PSB-60W-010-24VDC-IW, PSB-96W-010-24VDC-IW

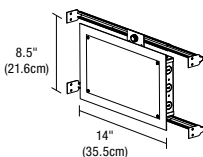

**8.5 x 14 inch In-Wall Mounting Kit:** Includes power supply, box cover and stud hangers for installing Junction Box in wall. Select "IW" in the options section of compatible power supply ordering codes if an In-Wall Mounting Kit is needed.

**Ordering Codes:** PSB-2X96W-010-24VDC-IW

PROJECT:

FIXTURE TYPE:

DATE:



**REQUIRED COMPONENTS:** 24VDC Lutron Compatible Power Supply.

<b>LUTRON HI-LUME® PREMIER .1% ECOSYSTEM® 3-WIRE POWER SUPPLY &amp; RECOMMENDED CONTROLLERS<sup>1</sup></b>	
<b>ORDERING CODES</b>	<b>L3D0-96W24V-U</b>
	
<b>SPECIFICATIONS</b>	
MAXIMUM LOAD	96W
INPUT VOLTAGE	120-277VAC
OUTPUT VOLTAGE	24VDC
DIMENSIONS	10.5" X 5.5" X 2"
CLASSIFICATION	CLASS 2
<b>DIMMING AND CONTROLS</b>	
RADIO RA2	•
HOMEWORKS QS	•
PHPM-3F-120	•
PHPM-3F-DV	•
BCI-0-10	•

<sup>1</sup>22K - 57K color temperatures are compatible with 0-10V, ELV, and Lutron Hi-lume® Power Supplies. Warm Dim (27D, 30D) color temperatures are only compatible with ELV power supplies. Tunable White (2K4K) color temperature is compatible with 0-10V, ELV, DMX, and Lutron Hi-lume® Power Supplies. Dynamic Color (RGB, RGB+W) and Static Color (Amber, Blue, Green, or Red) are compatible with DMX Power Supplies.

PROJECT:

FIXTURE TYPE:

DATE: