

CIRRUS CHANNEL SUSPENSION D1, DIRECT 1" LENS 24VDC SYSTEM, 85+ OR 95+CRI

REV.04.06.17

ASSEMBLED IN THE USA

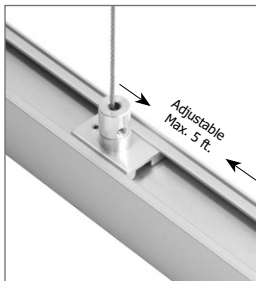
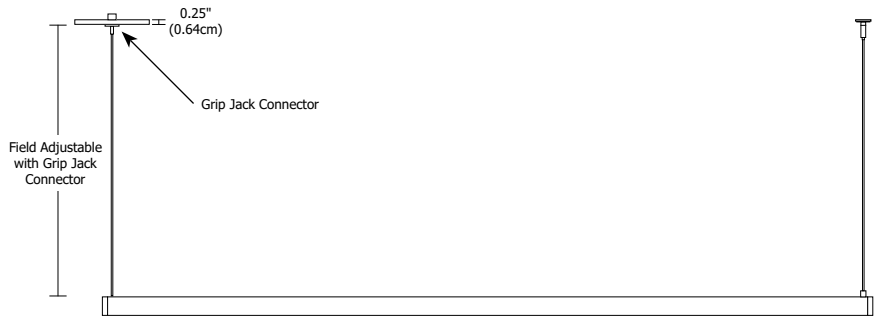
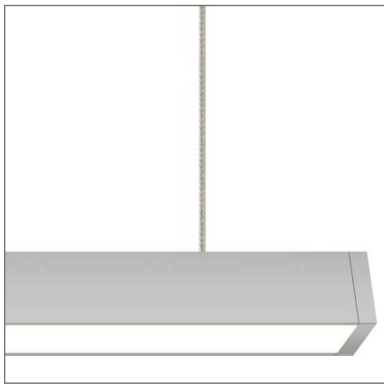

Description:

Cirrus Channel Suspension D1 features a direct flat lens with 100 degree beam spread. At 2.5 or 5 watts per feet, the 24VDC suspension contains 85+ or 95+CRI LEDs. Includes a 4 inch square canopy (additional Canopy options are available as accessories), a 12 feet power cable (for every run) and suspension cables (for support every 5 feet). It feeds power at the end using a standard junction box and must be wired into a Class 2 remote power supply up to 40 feet away. Available from 12 inches to 240 inches (5WDC) or 480 inches (2WDC). Lengths greater than 120 inches will ship as two or more segments that join together. Hardware and supporting cables are Antique Bronze for Antique Bronze and Black fixtures and are Satin Nickel for all other finishes. Power cables are Satin Nickel for all finish options. Fixtures include a 5 year warranty.

Finishes:

Satin Nickel, Chrome, Antique Bronze, Satin Aluminum, White and Satin Black Custom finishes available

Applications:

Indoor - Architectural lighting, general lighting and retail
Mount fixture 70 inch above finished floor

Lamp: The average LED Life is 50,000 hours

Version	Watts per Foot	Lumens		85+CRI 22K, 35K, 40K, 57K	95+CRI 27K, 30K
		per Watt	per Foot		
2WDC	2.5	40	108	●	●
5WDC	5	47	235	●	●

Lumen values are based on the 3000K LED test.

Remote Power Supplies* & Dimmers (Sold Separately):

- Electronic Low Voltage Dimming (ELV)
- 0-10 Volt Dimming (0-10V)
- Lutron

*In-Wall Mounting Kits available for select power supplies desired fixture location.

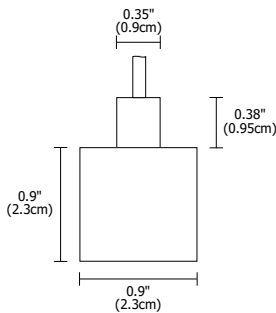

System	Lens	Wattage/Voltage	Nominal Size	Color Temperature	Finish
CCS	D1	2WDC	480IN	27K	SN
CCS Cirrus Channel Suspension	D1 Direct 0.9" Lens	2WDC 2.5 Watt 24 Volt DC 5WDC 5 Watt 24 Volt DC	12-480 Order in 12 inch increments up to 240 inches (5W) or 480 (2.5W) May be ordered in 3, 5, 8 or 10 inch increments	22K 2200K Amber White 27K 2700K Very Warm White 30K 3000K Warm White 35K 3500K Neutral White 40K 4000K Cool White 57K 5700K Daylight White	SN Satin Nickel CH Chrome BZ Antique Bronze SA Satin Aluminum BK Satin Black WH White

PROJECT:

FIXTURE TYPE:

DATE:



CIRRUS CHANNEL SUSPENSION D1, DIRECT 1" LENS 24VDC SYSTEM, 85+ OR 95+CRI

REV.04.06.17 ASSEMBLED IN THE USA

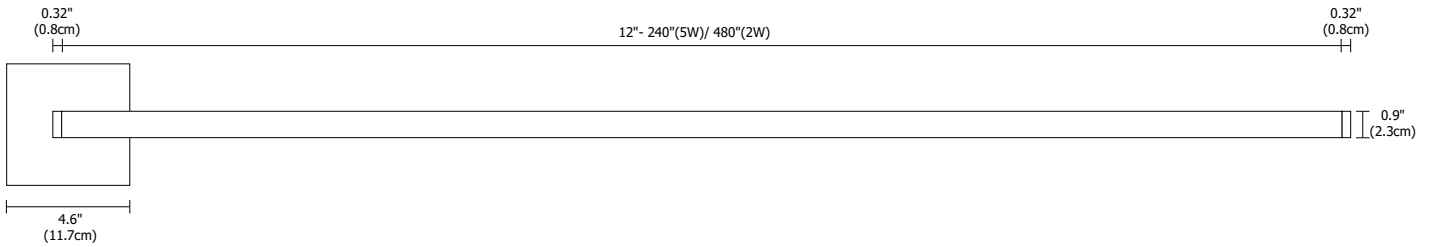
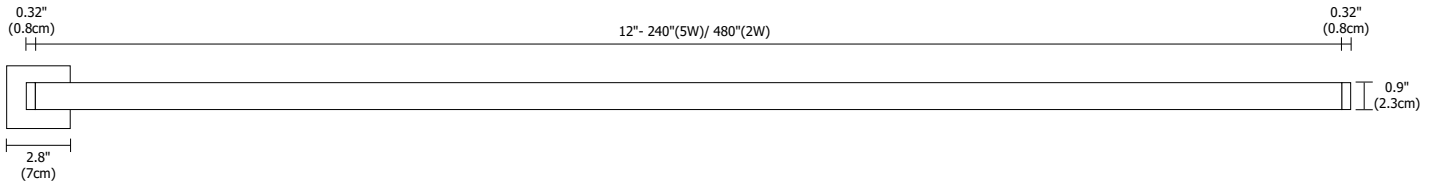

SA
Satin Aluminum



SN
Satin Nickel



BZ
Antique Bronze



BK
Satin Black



CH
Chrome



WH
White

Application: 0-10V dimming for Cirrus Suspension

Power Supply: Class 2, 24VDC output: 120VAC input, PSB-25W-010-24VDC; 120-277VAC input, PSB-96W-010-24VDC; PSB-2X96W-010 -24VDC

Dimming: Dimmable with 0-10V dimmer using power supplies above: Philips Sunrise SR1200ZTUNV, 0-10V dimmer recommended.

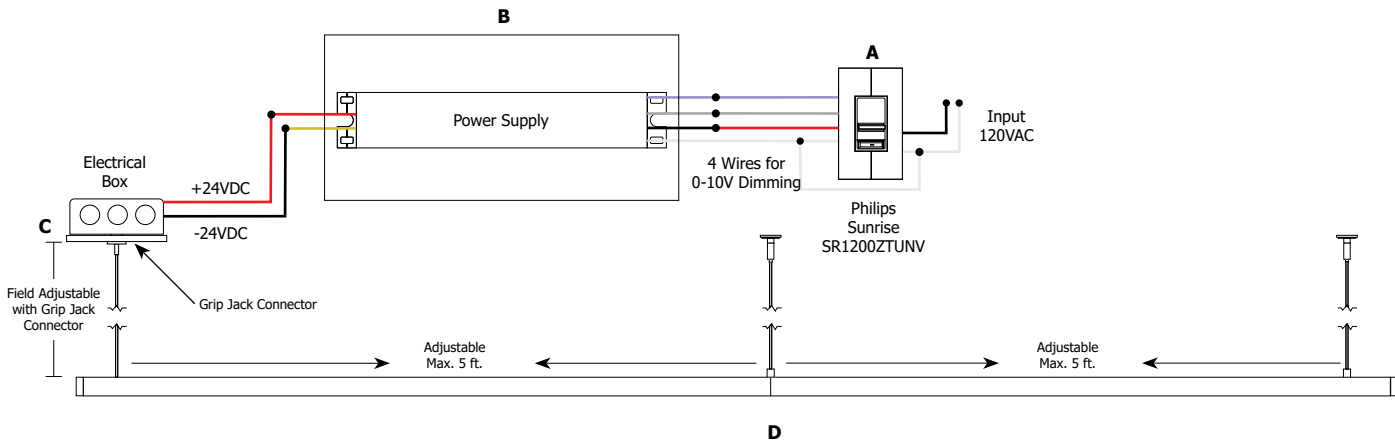

Warm White 100°		
Distance	Foot Candles 5W	Foot Candles 2.5W
2ft	126	71
3ft	62	35
4ft	39	22
6ft	20	12
8ft	12	7

A. Philips Sunrise 0-10V Dimmer
SR1200ZTUNV

B. 96W 24VDC Power Supply
PSB-96W-010-24VDC

C. 4.6" Square Canopy (included)

D. Cirrus Channel Suspension 12"- 480"
CCS-D1-_WDC-_IN-_K-_

PROJECT:

FIXTURE
TYPE:

DATE:



CIRRUS CHANNEL SUSPENSION D1, DIRECT 1" LENS ACTUAL LENGTHS

ORDERING CODE (NOMINAL SIZE)	LENGTH (INCHES)	ORDERING CODE (NOMINAL SIZE)	LENGTH (INCHES)	ORDERING CODE (NOMINAL SIZE)	LENGTH (INCHES)
12IN	13.1	108IN	109.1	204IN	205.4
15IN	15.5	111IN	111.5	207IN	207.8
17IN	17.9	113IN	113.9	209IN	210.2
20IN	20.3	116IN	116.3	212IN	212.6
22IN	22.7	118IN	118.7	214IN	215
24IN	25.1	120IN	121.1	216IN	217.4
27IN	27.5	123IN	123.8	219IN	219.8
29IN	29.9	125IN	126.2	221IN	222.2
32IN	32.3	128IN	128.6	224IN	224.6
34IN	34.7	130IN	131	226IN	227
36IN	37.1	132IN	133.4	228IN	229.4
39IN	39.5	135IN	135.8	231IN	231.8
41IN	41.9	137IN	138.2	233IN	234.2
44IN	44.3	140IN	140.6	236IN	236.6
46IN	46.7	142IN	143	238IN	239
48IN	49.1	144IN	145.4	240IN	241.4
51IN	51.5	147IN	147.8	243IN	244.1
53IN	53.9	149IN	150.2	245IN	246.5
56IN	56.3	152IN	152.6	248IN	248.9
58IN	58.7	154IN	155	250IN	251.3
60IN	61.1	156IN	157.4	252IN	253.7
63IN	63.5	159IN	159.8	255IN	256.1
65IN	65.9	161IN	162.2	257IN	258.5
68IN	68.3	164IN	164.6	260IN	260.9
70IN	70.7	166IN	167	262IN	263.3
72IN	73.1	168IN	169.4	264IN	265.7
75IN	75.5	171IN	171.8	267IN	268.1
77IN	77.9	173IN	174.2	269IN	270.5
80IN	80.3	176IN	176.6	272IN	272.9
82IN	82.7	178IN	179	274IN	275.3
84IN	85.1	180IN	181.4	276IN	277.7
87IN	87.5	183IN	183.8	279IN	280.1
89IN	89.9	185IN	186.2	281IN	282.5
92IN	92.3	188IN	188.6	284IN	284.9
94IN	94.7	190IN	191	286IN	287.3
96IN	97.1	192IN	193.4	288IN	289.7
99IN	99.5	195IN	195.8	291IN	292.1
101IN	101.9	197IN	198.2	294IN	294.5
104IN	104.3	199IN	200.6	296IN	296.9
106IN	106.7	202IN	203	298IN	299.3

PROJECT:

FIXTURE
TYPE:

DATE:



CIRRUS CHANNEL SUSPENSION D1, DIRECT 1" LENS ACTUAL LENGTHS

ORDERING CODE (NOMINAL SIZE)	LENGTH (INCHES)	ORDERING CODE (NOMINAL SIZE)	LENGTH (INCHES)
300IN	301.7	396IN	398
303IN	304.1	399IN	400.4
305IN	306.5	401IN	402.8
308IN	308.9	404IN	405.2
310IN	311.3	406IN	407.6
312IN	313.7	408IN	410
315IN	316.1	411IN	412.4
317IN	318.5	413IN	414.8
320IN	320.9	416IN	417.2
322IN	323.3	418IN	419.6
324IN	325.7	420IN	422
327IN	328.1	423IN	424.4
329IN	330.5	425IN	426.8
332IN	332.9	428IN	429.2
334IN	335.3	430IN	431.6
336IN	337.7	432IN	434
339IN	340.1	435IN	436.4
341IN	342.5	437IN	438.8
344IN	344.9	440IN	441.2
346IN	347.3	442IN	443.6
348IN	349.7	444IN	446
351IN	352.1	447IN	448.4
353IN	354.5	449IN	450.8
355IN	356.9	452IN	453.2
358IN	359.3	454IN	455.6
360IN	361.7	456IN	458
363IN	364.4	459IN	460.4
365IN	366.8	461IN	462.8
368IN	369.2	464IN	465.2
370IN	371.6	466IN	467.6
372IN	374	468IN	470
375IN	376.4	471IN	472.4
377IN	378.8	473IN	474.8
380IN	381.2	476IN	477.2
382IN	383.6	478IN	479.6
384IN	386	480IN	482
387IN	388.4		
389IN	390.8		
392IN	393.2		
394IN	395.6		





PROJECT:



FIXTURE
TYPE:

DATE:



REQUIRED COMPONENTS: 24VDC ELV Compatible Power Supplies.

ELECTRONIC LOW-VOLTAGE (ELV) POWER SUPPLIES & RECOMMENDED DIMMERS ¹					
ORDERING CODES	PS-40W-ELV-24VDC	PS-60L-ELV-24VDC	PSB-60W-ELV-24VDC*	PSB-2X60W-ELV-24VDC	PSB-100W-ELV-24VDC*
					
SPECIFICATIONS					
MAXIMUM LOAD	40W	60W	60W	2X60W	96W
INPUT VOLTAGE	120VAC	120VAC	120VAC	120VAC	120VAC
OUTPUT VOLTAGE	24VDC	24VDC	24VDC	24VDC	24VDC
DIMENSIONS	1.4" X 3" X 1"	2.25" X 1.25" X 0.83"	8.125" X 2" X 1.75"	12.15" X 6.48" X 2.18"	9.25" X 3.5" X 2"
CLASSIFICATION	CLASS 2	CLASS 2	CLASS 2	CLASS 2	CLASS 2
DIMMING AND CONTROLS					
LUTRON DIVA: DVELV-300P	•	•	•	•	•
LUTRON SKYLARK: SELV-300P	•	•	•	•	•
LUTRON RADIO RA2: RRD-6NA	N/A	N/A	•	•	•
LUTRON MAESTRO: MAELV-600	•	•	•	•	•
LEGRAND ADORNE: ADTP-703TUM4	N/A	N/A	•	•	•





ELECTRONIC LOW-VOLTAGE (ELV) POWER SUPPLIES & RECOMMENDED DIMMERS ¹			
ORDERING CODES	PSB-2X100W-ELV-24VDC*	PSB-3X100W-ELV-24VDC	PSB-4X100W-ELV-24VDC
			
SPECIFICATIONS			
MAXIMUM LOAD	2X96W	3X96W	4X96W
INPUT VOLTAGE	120VAC	120VAC	120VAC
OUTPUT VOLTAGE	24VDC	24VDC	24VDC
DIMENSIONS	12.15" X 6.48" X 2.18"	14" X 10" X 3"	17" X 13" X 3"
CLASSIFICATION	CLASS 2	CLASS 2	CLASS 2
DIMMING AND CONTROLS			
LUTRON DIVA: DVELV-300P	•	•	•
LUTRON SKYLARK: SELV-300P	•	•	•
LUTRON RADIO RA2: RRD-6NA	•	•	•
LUTRON MAESTRO: MAELV-600	•	•	•
LEGRAND ADORNE: ADTP-703TUM4	•	•	•



¹22K - 57K color temperatures are compatible with 0-10V, ELV, and Lutron Power Supplies.

*In-Wall Mounting Kits available for select power supplies.



REQUIRED COMPONENTS: 24VDC 0-10V Compatible Power Supplies.

0-10 VOLT (010) POWER SUPPLIES & RECOMMENDED DIMMERS ¹				
ORDERING CODES	PSB-25W-010-24VDC 	PSB-60W-010-24VDC* 	PSB-96W-010-24VDC* 	PSB-2X96W-010-24VDC* 
SPECIFICATIONS				
MAXIMUM LOAD	25W	60W	96W	2X96W
INPUT VOLTAGE	120VAC	120-277VAC	120-277VAC	120-277VAC
OUTPUT VOLTAGE	24VDC	24VDC	24VDC	24VDC
DIMENSIONS	12.4" X 3.12" X 2.18"	12.4" X 3.12" X 2.18"	12.4" X 3.12" X 2.18"	12.15" X 6.48" X 2.18"
CLASSIFICATION	CLASS 2	CLASS 2	CLASS 2	CLASS 2
DIMMING AND CONTROLS				
PHILIPS SUNRISE: SR1200ZTUNV	•	•	•	•
LUTRON DIVA:: DVTV-WH	•	•	•	•
LUTRON NOVA T: NTSTV-DV-XX	•	•	•	•
LUTRON GRAFIX EYE QS: QSGRJ-XP	•	•	•	•
LUTRON RADIO RA2: RRD-10ND	•	•	•	•
LEVITON: LEV40050	•	•	•	•
LEVITON IP710-DLX: IP710-DLX	•	•	•	•
LEGRAND: ADPD4FBL3P2W4	•	•	•	•

0-10 VOLT (010) POWER SUPPLIES & RECOMMENDED DIMMERS ¹		
ORDERING CODES	PSB-3X96W-010-24VDC 	PSB-4X96W-010-24VDC 
SPECIFICATIONS		
MAXIMUM LOAD	3X96W	4X96W
INPUT VOLTAGE	120-277VAC	120-277VAC
OUTPUT VOLTAGE	24VDC	24VDC
DIMENSIONS	14" X 10" X 3"	17" X 13" X 3"
CLASSIFICATION	CLASS 2	CLASS 2
DIMMING AND CONTROLS		
PHILIPS SUNRISE: SR1200ZTUNV	•	•
LUTRON DIVA: DVTV-WH	•	•
LUTRON NOVA T: NTSTV-DV-XX	•	•
LUTRON GRAFIX EYE QS: QSGRJ-XP	•	•
LUTRON RADIO RA2: RRD-10ND	•	•
LEVITON: LEV40050	•	•
LEVITON IP710-DLX: IP710-DLX	•	•
LEGRAND: ADPD4FBL3P2W4	•	•

¹22K - 57K color temperatures are compatible with 0-10V, ELV, and Lutron Power Supplies.

*In-Wall Mounting Kits available for select power supplies.

REQUIRED COMPONENTS: 24VDC Lutron Compatible Power Supply.

LUTRON HI-LUME® PREMIER .1% ECOSYSTEM® 3-WIRE POWER SUPPLY & RECOMMENDED CONTROLLERS ¹	
ORDERING CODES	<p>L3D0-96W24V-U</p> 
SPECIFICATIONS	
MAXIMUM LOAD	96W
INPUT VOLTAGE	120-277VAC
OUTPUT VOLTAGE	24VDC
DIMENSIONS	10.5" X 5.5" X 2"
CLASSIFICATION	CLASS 2
DIMMING AND CONTROLS	
RADIORA 2 DIMMER	•
HOMEWORKS QS DIMMER	•
PHPM-3F-120, PHPM-3F-DV AND BCI-0-10 INTERFACES	•

¹22K - 57K color temperatures are compatible with 0-10V, ELV, and Lutron Power Supplies.

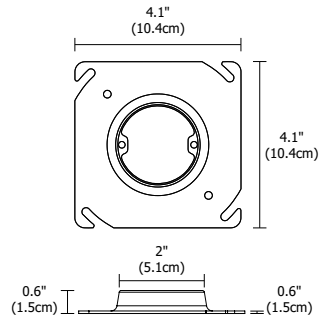

New Construction Junction Box Cover

Included with the 2 inch round and square canopies and is not required for the 4 inch square canopy. May be ordered separately as a rough-in component or replacement part. New Construction Junction Box Cover mounts to a standard 4 inch electrical box or octagon box, converting to a 2 inch plaster ring for new construction.

System	Type
NC2	JBOX
<small>NC2 New Construction 2"</small>	<small>JBOX JBox Cover</small>



2RD 2 Inch Round Canopy



2SQ 2 Inch Square Canopy

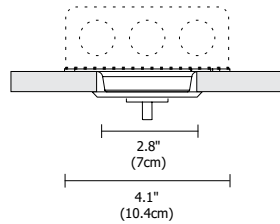

2 Inch Round or Square Canopy with Junction Box

The Cirrus Channel Linear Suspension includes a 4 inch Square Canopy; however, the 2 inch Round or Square Canopies are additional canopy options that can be ordered as accessories. The 2 inch Round or Square Canopy with Junction Box includes a special plaster ring that fits on a 4 inch square or octagon Junction Box.

Product	Size	Type	Finish
CCS	2SQ	JBOX	SN
<small>CCS Cirrus Channel Suspension</small>	<small>2SQ 2.8" Square 2RD 2.8" Round</small>	<small>JBOX Junction Box</small>	<small>SN Satin Nickel CH Chrome BZ Antique Bronze SA Satin Aluminum BK Satin Black WH White</small>

4 Inch Canopy (Not Included)

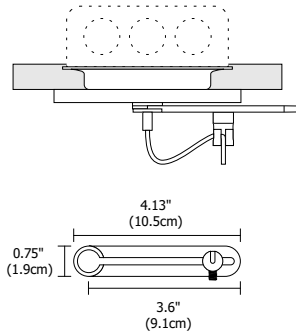

Cirrus Suspension Adjustable Swag Hook

Cirrus Suspension Adjustable Swag Hook allows a cable to form a straight connection to the channel when the Power Canopy is not located directly above the fixture. The Adjustable Swag Hook is compatible with the 2SQ, 2RD, and 4 inch square canopies. The Adjustable Swag Hook does not include canopy.

Product	Options	Type	Finish
CS	ADJ	SWAG	SN
<small>CS Channel Suspension</small>	<small>ADJ Adjustable</small>	<small>SWAG Swag Hook</small>	<small>SN Satin Nickel</small>

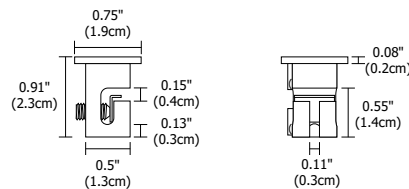

Channel Suspension Swag Hook

Swag Hook extends a cable to an electrical box that is not located directly above desired fixture location.

System	Type
CS	SWAG
<small>CS Channel Suspension</small>	<small>SWAG Swag Hook</small>

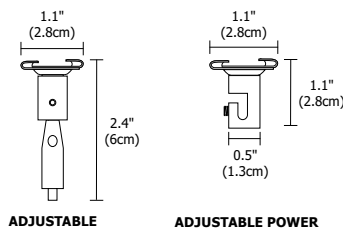

Cirrus Suspension Adjustable T-Bar Clip

Cirrus Suspension Adjustable T-Bar Clip mounts rigid or adjustable Cirrus aircraft cables to T-Bar grid ceilings. Available as adjustable power and non-power versions.

Product	Type	Options	Finish
CS	TBAR	A	W
<small>CS Channel Suspension</small>	<small>TBAR 9/16" and 15/16"</small>	<small>A Adjustable AP Adjustable Power</small>	<small>W White B Black</small>

PROJECT:

FIXTURE
TYPE:

DATE:



TM-30-15 DATA: The data below is for SS2C and SS5C bare LED Soft Strips. Consistent color temperatures throughout a single strip and among multiple strips is possible through a 3 phase binning process in which each order is inspected with a color meter to ensure uniformity.

2200K | Rf: 83.9 | Rg: 94.9

COLOR VECTOR GRAPHIC

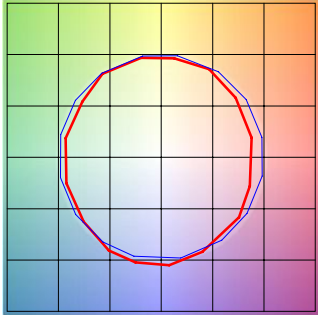

■ Test ■ Reference

HUE BIN	Rf	GRAPHIC SHIFTS %	
		CHROMA	HUE
1	77.6	-10.0%	1.8%
2	80.7	-7.5%	7.0%
3	79.5	-2.9%	8.9%
4	90.5	-3.1%	2.4%
5	93.9	-1.3%	1.9%
6	91.9	-0.9%	-0.2%
7	87.6	-6.3%	-2.7%
8	90.5	-5.4%	2.7%
9	83.8	-4.7%	6.5%
10	81.2	-2.5%	10.0%
11	83.3	3.9%	9.4%
12	86.4	5.6%	2.6%
13	86.2	4.5%	-12.4%
14	64.3	-1.0%	-21.9%
15	85.1	-4.4%	-7.5%
16	75.0	-9.9%	-12.0%

2700K | Rf: 87.7 | Rg: 96.1

COLOR VECTOR GRAPHIC

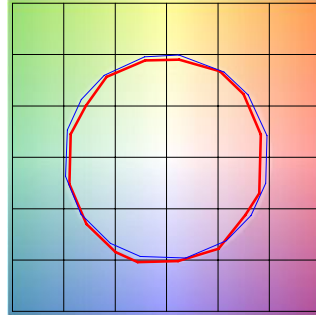

■ Test ■ Reference

HUE BIN	Rf	GRAPHIC SHIFTS %	
		CHROMA	HUE
1	86.4	-5.6%	2.3%
2	89.7	-3.3%	3.1%
3	90.5	-1.5%	3.8%
4	90.0	-4.3%	1.1%
5	92.9	-3.7%	0.2%
6	93.5	-2.5%	-0.8%
7	86.3	-7.2%	2.5%
8	90.7	-4.0%	3.2%
9	85.2	-2.4%	8.1%
10	81.7	0.9%	10.8%
11	85.4	4.5%	8.9%
12	88.7	5.7%	-1.4%
13	88.3	1.3%	-7.9%
14	85.1	2.4%	-10.4%
15	88.1	-4.8%	-2.7%
16	81.7	-4.3%	-10.9%

3000K | Rf: 88.1 | Rg: 99.7

COLOR VECTOR GRAPHIC

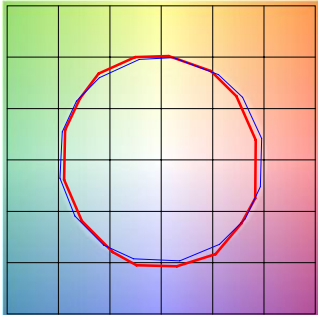

■ Test ■ Reference

HUE BIN	Rf	GRAPHIC SHIFTS %	
		CHROMA	HUE
1	87.7	-5.9%	-0.3%
2	87.9	-4.4%	4.3%
3	82.9	-1.2%	7.9%
4	89.9	0.6%	4.7%
5	92.7	3.0%	3.5%
6	92.7	3.6%	-1.7%
7	90.8	-1.3%	-4.4%
8	93.7	-2.5%	-2.2%
9	91.7	-3.7%	2.3%
10	85.5	-2.8%	7.8%
11	83.3	0.7%	11.0%
12	86.4	5.5%	3.8%
13	90.6	4.6%	-3.6%
14	85.6	5.9%	-8.4%
15	89.5	-0.6%	-5.7%
16	82.6	-2.7%	-12.0%

3500K | Rf: 86.1 | Rg: 95.5

COLOR VECTOR GRAPHIC

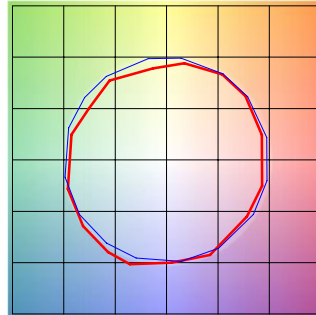

■ Test ■ Reference

HUE BIN	Rf	GRAPHIC SHIFTS %	
		CHROMA	HUE
1	86.6	-4.2%	3.4%
2	91.7	-1.4%	1.8%
3	94.9	-0.7%	0.4%
4	87.9	-4.5%	-4.1%
5	85.9	-10.3%	-2.7%
6	89.8	-5.2%	-0.4%
7	79.6	-9.5%	6.5%
8	87.6	-4.0%	5.7%
9	81.4	-0.5%	11.8%
10	78.3	3.3%	11.4%
11	85.7	6.3%	6.1%
12	86.3	7.1%	-4.6%
13	86.1	-0.7%	-9.6%
14	85.1	0.8%	-10.4%
15	83.4	-4.1%	-5.3%
16	82.5	-3.6%	-5.7%

4000K | Rf: 87.6 | Rg: 96.8

COLOR VECTOR GRAPHIC

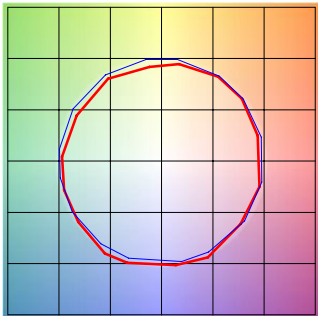

■ Test ■ Reference

HUE BIN	Rf	GRAPHIC SHIFTS %	
		CHROMA	HUE
1	89.0	-3.1%	2.1%
2	93.2	-0.9%	1.3%
3	94.3	-1.1%	0.7%
4	89.5	-4.0%	-2.3%
5	87.6	-7.8%	-1.8%
6	92.2	-4.6%	0.1%
7	87.4	-6.6%	3.6%
8	85.7	-3.8%	7.0%
9	81.5	-1.3%	12.4%
10	80.0	0.9%	11.4%
11	83.3	5.9%	8.7%
12	89.7	4.8%	-0.3%
13	88.5	2.4%	-6.3%
14	92.7	4.0%	-3.8%
15	86.1	-1.6%	-4.5%
16	85.0	-1.4%	-5.0%

5700K | Rf: 80.3 | Rg: 91.5

COLOR VECTOR GRAPHIC

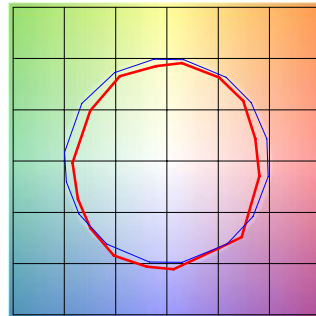

■ Test ■ Reference

HUE BIN	Rf	GRAPHIC SHIFTS %	
		CHROMA	HUE
1	73.8	-11.2%	2.6%
2	83.7	-5.5%	5.8%
3	84.2	-4.0%	5.5%
4	85.8	-3.5%	1.3%
5	85.3	-7.1%	0.6%
6	89.2	-5.8%	-2.2%
7	81.5	-10.7%	1.2%
8	75.7	-9.7%	8.5%
9	74.9	-7.8%	18.8%
10	67.8	-1.6%	18.0%
11	76.1	5.5%	12.0%
12	90.8	4.9%	-1.6%
13	83.6	5.0%	-9.5%
14	81.7	-1.2%	-10.0%
15	69.0	2.0%	-22.8%
16	83.2	-8.5%	-1.0%