

**Description:** Verge, a Slim, plaster-in aluminum channel with 4 inch paintable aluminum backer plate highlights the transition where two drywall surfaces verge together, while emitting ambient illumination. The 24VDC linear LED system mounts directly to studs without joist modification and plasters into 5/8 inch or thicker drywall. Verge is sold in 5 foot increments up to 40 feet and may be field-cut to any length. Several color temperature options are available, including 22K – 57K (ELV/010), Warm Dim (ELV), Tunable White (ELV/010/DMX), RGB and RGBW (DMX). High CRI commercial-grade white or dynamic color-changing LED Soft Strip projects a clean line of light. Coordinate installation with electrician and drywall contractors. Includes a 5-year pro-rated warranty.

**Design Note:** Verge wall may be installed on a single surface for toe-kick and cove lighting applications. Ambient and harmonious, the plaster-in LED system blends into 5/8 inch thick drywall to enhance the contemporary aesthetic of interior spaces. Verge offers unsurpassed flexibility that transforms interiors into thoughtful, unique works of art.

**Applications:** Indoor damp or dry locations only. A Wall mount for use as cove lighting and floating wall effects for hospitality, retail, and residential.

**Lamp:** The average LED Life is 50,000 hours

Watts per Foot	Lumens per Watt	Lumens per Foot	85+CRI	90+CRI	92+CRI	95+CRI	RGB	RGBW
2WDC (2.5WDC)	57	186	22K, 35K, 40K, 57K	2K4K	27D, 30D	27K, 30K		
3WDC	N/A	N/A						
5WDC	N/A	N/A						
6WDC	N/A	N/A						

Lumen values are based on the 3000K LED test.

**Remote Power Supplies\*, Dimmers & Controls (Sold Separately):**

- Electronic Low Voltage Dimming (ELV)
- 0-10 Volt Dimming (0-10V)
- Dynamic Color Changing (DMX)

\*In-Wall Mounting Kits available for select power supplies

**Included Components:** Junction Box, Adjustable Mounting Bars, Backer Plate, Verge Wall Channel(s), Drywall Screws, LED Soft Strip, and Lens(es)

**ORDERING CODE**

System	Watts per Foot	Length in Feet	Color Temperature
<b>VG</b> Verge Wall	<b>2WDC</b> 2WDC 2.5 Watts 3WDC 3 Watts (35 foot max) 5WDC 5 Watts (20 foot max) 6WDC 6 Watts (15 foot max)	<b>10FT</b> 5FT 5 Feet    25FT 25 Feet 10FT 10 Feet    30FT 30 Feet 15FT 15 Feet    35FT 35 Feet 20FT 20 Feet    40FT 40 Feet	<b>27K</b> 22K 2200K Amber White 27K 2700K Very Warm White 27D 2700K Warm Dim (5WDC only) 30K 3000K Warm White 30D 3000K Warm Dim (5WDC only) 35K 3500K Neutral White 40K 4000K Cool White 57K 5700K Daylight White 2K4K 2000K-4000K Tunable White (5WDC only) RGB Red, Green, and Blue (3WDC only) RGBW Red, Green, Blue, and 2000K White (6WDC only)

For custom design and layout assistance, send drawings to design@PureEdgeLighting.com

COMPANY		FIXTURE TYPE		DATE	
PROJECT		APPROVED BY			

Product specification subject to change without notification. REV.04.06.17



INCLUDED COMPONENTS

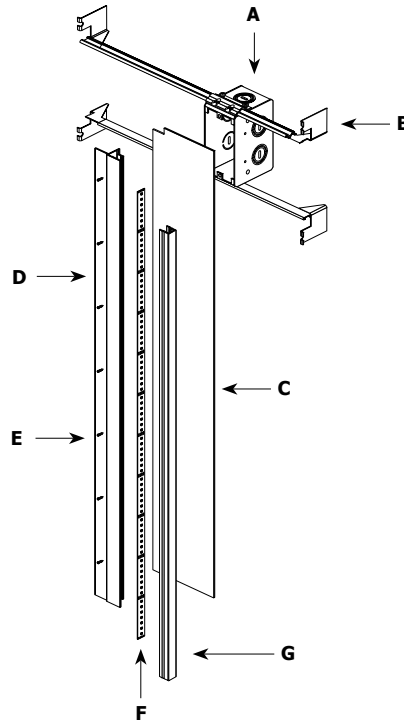

**A. Junction Box:** Mounts behind drywall with Adjustable Mounting Bars. Low voltage 24VDC wires from Remote Power Supply connect to LED wires inside box. Junction Box opening is covered by the Backer Plate, and required at the beginning of each run.

**B. Adjustable Mounting Bars:** Provide flexibility for mounting in a variety of spaces. Verge Corner includes two sets of mounting hardware.

**C. Backer Plate:** 4-inch paintable aluminum plate that conceals Junction Box and reflects light. Verge Corner includes two backer plates.

**D. Verge Channel:** 5/8 inch deep extrusions each house a single row of commercial-grade white or dynamic color-changing LED Soft Strip.

**E. Drywall Screws:** Secure channel to drywall and stud.

**F. LED Soft Strip:** Commercial grade white or dynamic color-changing LED Soft Strip. See lamp data on for additional details.

**G. Lens:** .6 inch wide diffuser lens projects a clean line of light without LED dots. Verge Corner includes two lenses.

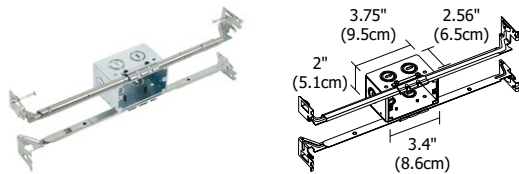

**Rough-In Component**

**Junction Box:** One Junction Box is included with Verge Wall and two Junction Boxes are included with Verge Corner. Order additional Junction Box(es) separately to rough-in electrical wiring before drywall installation. Quick shipment available.

System	Size	Component
<b>VG</b>	<b>1RE</b>	<b>JBOX</b>
VG Verge Wall	1RE 1" Rectangle	JBOX Junction Box

COMPANY		FIXTURE TYPE		DATE	
PROJECT		APPROVED BY			

Product specification subject to change without notification. REV.04.06.17





INSTALLATION

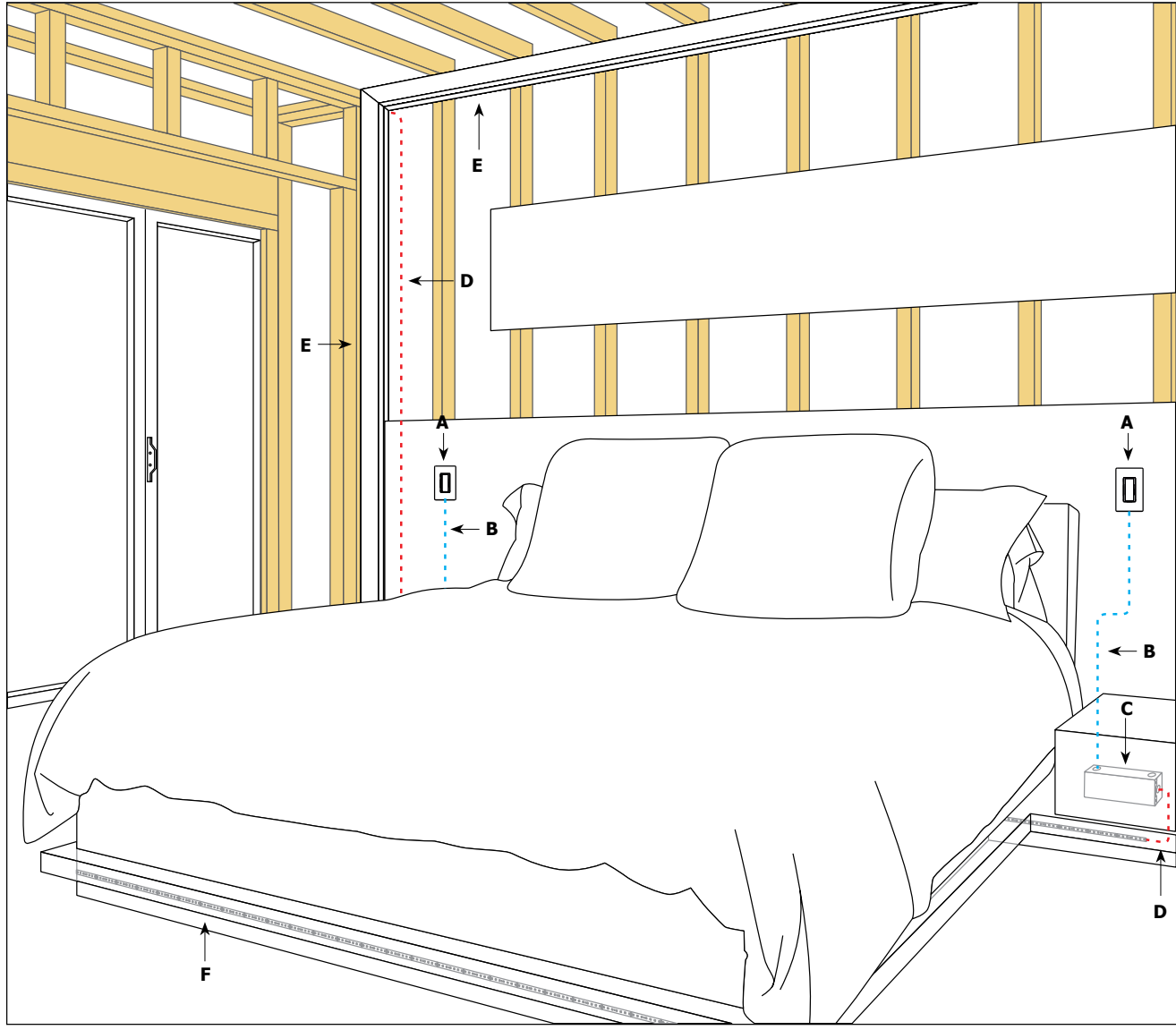

- A.** Dimmer or Switch
- B.** 120VAC wiring
- C.** 120V/24VDC remote power supply for In-Wall Mounting Kit
- D.** 24VDC, Class 2 wiring
- E.** Verge Wall Channel
- F.** LED Soft Strip

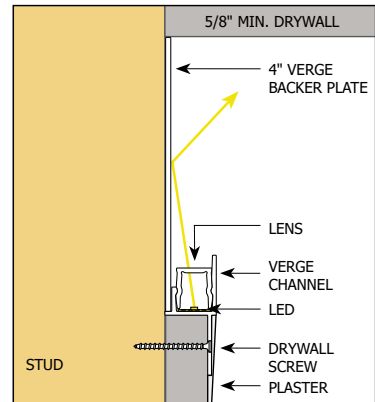

Direction of Light

A Division of PureEdge Lighting 1718 W. Fullerton Chicago, IL 60614 • Ph: 773.770.1196 • Fax: 773.883.6128 • www.purelighting.com



COMPANY		FIXTURE TYPE		DATE	
PROJECT		APPROVED BY			



**Application:** 0-10V dimming for Verge

**Power Supply:** PSB-96W-010-24VDC (24VDC 96W output) | PSB-2X96W-010-24VDC (24VDC 2X96W output).

**Dimming:** Radio Ra2 (with GRX-TVI), Grafik Eye Qs (with GRX-TVI), Diva (with PP20); Nova T; Philips: Sunrise SR1200ZTUNV; Leviton: IP710-LF.

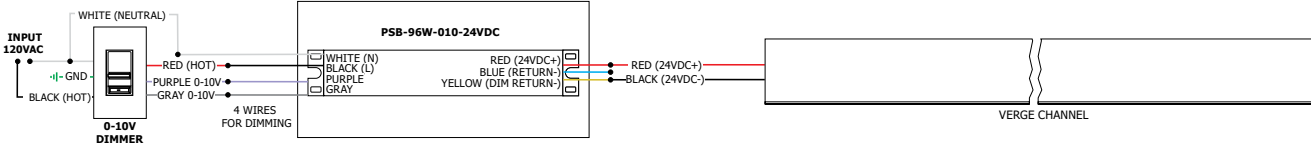

### 2.5 WATTS PER FOOT - 22K, 27K, 30K, 35K, 40K AND 57K WHITE LEDS

LENGTH IN FEET	WATTS
1	3
2	5
3	8
4	10
5	13
6	15
7	17
8	20
9	22
10	25

LENGTH IN FEET	WATTS
11	27
12	29
13	32
14	34
15	37
16	39
17	41
18	44
19	46
20	48

LENGTH IN FEET	WATTS
21	51
22	54
23	56
24	58
25	61
26	63
27	66
28	68
29	70
30	73

LENGTH IN FEET	WATTS
31	75
32	78
33	80
34	82
35	85
36	87
37	90
38	92
39	94
40	96

### 5 WATTS PER FOOT - 22K, 27K, 27D, 30K, 30D, 35K, 40K AND 57K WHITE LEDS

LENGTH IN FEET	WATTS
1	5
2	10
3	14
4	19
5	24

LENGTH IN FEET	WATTS
6	29
7	34
8	38
9	43
10	48

LENGTH IN FEET	WATTS
11	53
12	58
13	63
14	67
15	72

LENGTH IN FEET	WATTS
16	77
17	82
18	87
19	91
20	96

COMPANY		FIXTURE TYPE		DATE	
PROJECT		APPROVED BY			

Product specification subject to change without notification. REV.04.06.17

A Division of PureEdge Lighting 1718 W. Fullerton Chicago, IL 60614 • Ph: 773.770.1196 • Fax: 773.883.6128 • www.purelighting.com





5 WATTS PER FOOT - 2K4K TUNABLE WHITE LEDS

LENGTH IN FEET	2K WATTS	4K WATTS
1	3	3
2	5	5
3	8	8
4	10	10
5	12	12
6	15	15
7	17	17

LENGTH IN FEET	2K WATTS	4K WATTS
8	20	20
9	22	22
10	24	24
11	27	27
12	29	29
13	32	32
14	34	34

LENGTH IN FEET	2K WATTS	4K WATTS
15	36	36
16	39	39
17	41	41
18	44	44
19	46	46
20	48	48

3 WATTS PER FOOT - RGB LEDS

LENGTH IN FEET	WATTS
1	3
2	6
3	8
4	11
5	13
6	16
7	19
8	21
9	24

LENGTH IN FEET	WATTS
10	26
11	29
12	32
13	34
14	37
15	39
16	42
17	45
18	47

LENGTH IN FEET	WATTS
19	50
20	52
21	55
22	58
23	60
24	63
25	65
26	68
27	71

LENGTH IN FEET	WATTS
28	73
29	76
30	78
31	81
32	84
33	86
34	89
35	91

6 WATTS PER FOOT - RGBW LEDS

LENGTH IN FEET	WATTS
1	6
2	12
3	18
4	24

LENGTH IN FEET	WATTS
5	30
6	36
7	42
8	48

LENGTH IN FEET	WATTS
9	54
10	60
11	66
12	72

LENGTH IN FEET	WATTS
13	78
14	84
15	90
16	96

A Division of PureEdge Lighting 1718 W. Fullerton Chicago, IL 60614 • Ph: 773.770.1196 • Fax: 773.883.6128 • www.purelighting.com



COMPANY		FIXTURE TYPE		DATE	
PROJECT		APPROVED BY			



**TM-30-15 DATA:** The data below is for SS2C and SS5C bare LED Soft Strips. Consistent color temperatures throughout a single strip and among multiple strips is possible through a 3 phase binning process in which each order is inspected with a color meter to ensure uniformity.

**2200K** | Rf: 83.9 | Rg: 94.9

COLOR VECTOR GRAPHIC

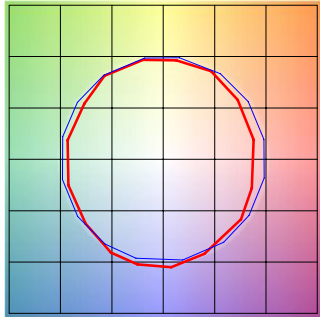

■ Test ■ Reference

HUE BIN	Rf	GRAPHIC SHIFTS %	
		CHROMA	HUE
1	77.6	-10.0%	1.8%
2	80.7	-7.5%	7.0%
3	79.5	-2.9%	8.9%
4	90.5	-3.1%	2.4%
5	93.9	-1.3%	1.9%
6	91.9	-0.9%	-0.2%
7	87.6	-6.3%	-2.7%
8	90.5	-5.4%	2.7%
9	83.8	-4.7%	6.5%
10	81.2	-2.5%	10.0%
11	83.3	3.9%	9.4%
12	86.4	5.6%	2.6%
13	86.2	4.5%	-12.4%
14	64.3	-1.0%	-21.9%
15	85.1	-4.4%	-7.5%
16	75.0	-9.9%	-12.0%

**2700K** | Rf: 87.7 | Rg: 96.1

COLOR VECTOR GRAPHIC

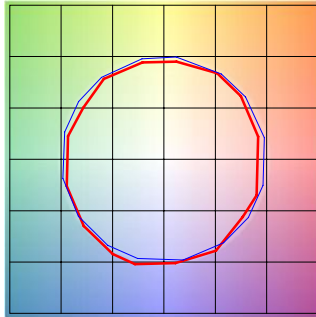

■ Test ■ Reference

HUE BIN	Rf	GRAPHIC SHIFTS %	
		CHROMA	HUE
1	86.4	-5.6%	2.3%
2	89.7	-3.3%	3.1%
3	90.5	-1.5%	3.8%
4	90.0	-4.3%	1.1%
5	92.9	-3.7%	0.2%
6	93.5	-2.5%	-0.8%
7	86.3	-7.2%	2.5%
8	90.7	-4.0%	3.2%
9	85.2	-2.4%	8.1%
10	81.7	0.9%	10.8%
11	85.4	4.5%	8.9%
12	88.7	5.7%	-1.4%
13	88.3	1.3%	-7.9%
14	85.1	2.4%	-10.4%
15	88.1	-4.8%	-2.7%
16	81.7	-4.3%	-10.9%

**3000K** | Rf: 88.1 | Rg: 99.7

COLOR VECTOR GRAPHIC

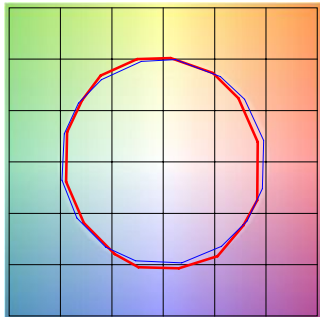

■ Test ■ Reference

HUE BIN	Rf	GRAPHIC SHIFTS %	
		CHROMA	HUE
1	87.7	-5.9%	-0.3%
2	87.9	-4.4%	4.3%
3	82.9	-1.2%	7.9%
4	89.9	0.6%	4.7%
5	92.7	3.0%	3.5%
6	92.7	3.6%	-1.7%
7	90.8	-1.3%	-4.4%
8	93.7	-2.5%	-2.2%
9	91.7	-3.7%	2.3%
10	85.5	-2.8%	7.8%
11	83.3	0.7%	11.0%
12	86.4	5.5%	3.8%
13	90.6	4.6%	-3.6%
14	85.6	5.9%	-8.4%
15	89.5	-0.6%	-5.7%
16	82.6	-2.7%	-12.0%

**3500K** | Rf: 86.1 | Rg: 95.5

COLOR VECTOR GRAPHIC

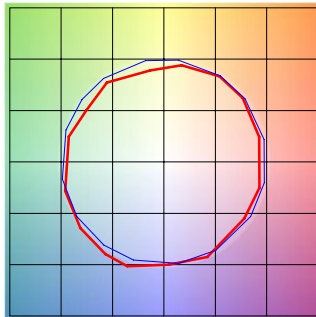

■ Test ■ Reference

HUE BIN	Rf	GRAPHIC SHIFTS %	
		CHROMA	HUE
1	86.6	-4.2%	3.4%
2	91.7	-1.4%	1.8%
3	94.9	-0.7%	0.4%
4	87.9	-4.5%	-4.1%
5	85.9	-10.3%	-2.7%
6	89.8	-5.2%	-0.4%
7	79.6	-9.5%	6.5%
8	87.6	-4.0%	5.7%
9	81.4	-0.5%	11.8%
10	78.3	3.3%	11.4%
11	85.7	6.3%	6.1%
12	86.3	7.1%	-4.6%
13	86.1	-0.7%	-9.6%
14	85.1	0.8%	-10.4%
15	83.4	-4.1%	-5.3%
16	82.5	-3.6%	-5.7%

**4000K** | Rf: 87.6 | Rg: 96.8

COLOR VECTOR GRAPHIC

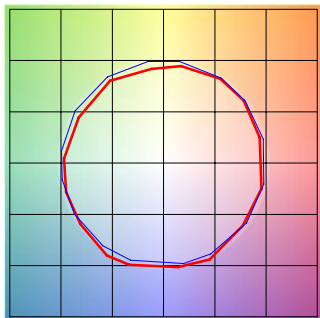

■ Test ■ Reference

HUE BIN	Rf	GRAPHIC SHIFTS %	
		CHROMA	HUE
1	89.0	-3.1%	2.1%
2	93.2	-0.9%	1.3%
3	94.3	-1.1%	0.7%
4	89.5	-4.0%	-2.3%
5	87.6	-7.8%	-1.8%
6	92.2	-4.6%	0.1%
7	87.4	-6.6%	3.6%
8	85.7	-3.8%	7.0%
9	81.5	-1.3%	12.4%
10	80.0	0.9%	11.4%
11	83.3	5.9%	8.7%
12	89.7	4.8%	-0.3%
13	88.5	2.4%	-6.3%
14	92.7	4.0%	-3.8%
15	86.1	-1.6%	-4.5%
16	85.0	-1.4%	-5.0%

**5700K** | Rf: 80.3 | Rg: 91.5

COLOR VECTOR GRAPHIC

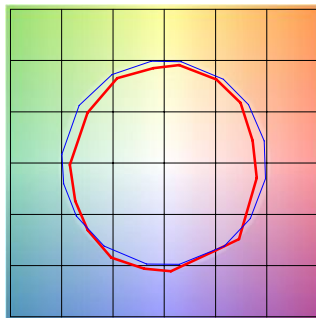

■ Test ■ Reference

HUE BIN	Rf	GRAPHIC SHIFTS %	
		CHROMA	HUE
1	73.8	-11.2%	2.6%
2	83.7	-5.5%	5.8%
3	84.2	-4.0%	5.5%
4	85.8	-3.5%	1.3%
5	85.3	-7.1%	0.6%
6	89.2	-5.8%	-2.2%
7	81.5	-10.7%	1.2%
8	75.7	-9.7%	8.5%
9	74.9	-7.8%	18.8%
10	67.8	-1.6%	18.0%
11	76.1	5.5%	12.0%
12	90.8	4.9%	-1.6%
13	83.6	5.0%	-9.5%
14	81.7	-1.2%	-10.0%
15	69.0	2.0%	-22.8%
16	83.2	-8.5%	-1.0%

A Division of PureEdge Lighting 1718 W. Fullerton Chicago, IL 60614 • Ph: 773.770.1196 • Fax: 773.883.6128 • www.purelighting.com



COMPANY		FIXTURE TYPE		DATE	
PROJECT		APPROVED BY			

Product specification subject to change without notification. REV.04.06.17



**TM-30-15 DATA:** The data below is for SS2C and SS5C bare LED Soft Strips. Consistent color temperatures throughout a single strip and among multiple strips is possible through a 3 phase binning process in which each order is inspected with a color meter to ensure uniformity.

**2700D** | Rf: 89.5 | Rg: 100.8

COLOR VECTOR GRAPHIC

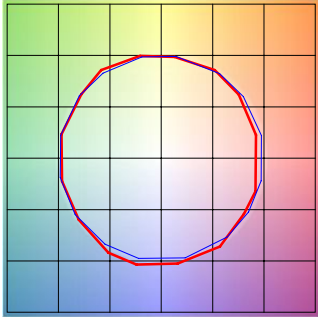

■ Test ■ Reference

HUE BIN	Rf	GRAPHIC SHIFTS %	
		CHROMA	HUE
1	88.8	-5.1%	1.4%
2	89.8	-2.7%	4.1%
3	87.2	0.3%	5.9%
4	92.3	-0.9%	1.0%
5	93.3	1.5%	1.7%
6	92.4	3.6%	-0.2%
7	92.2	-0.9%	-2.4%
8	96.7	-0.4%	-1.1%
9	92.3	-1.2%	3.7%
10	88.9	-0.0%	6.1%
11	86.4	5.1%	7.4%
12	88.2	6.3%	-0.9%
13	87.2	3.8%	-8.1%
14	84.2	3.8%	-11.0%
15	89.8	-2.6%	-4.3%
16	82.7	-3.4%	-11.1%

**3000D** | Rf: 89.8 | Rg: 101.4

COLOR VECTOR GRAPHIC

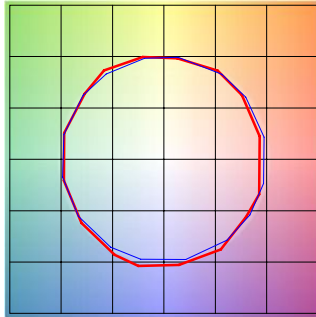

■ Test ■ Reference

HUE BIN	Rf	GRAPHIC SHIFTS %	
		CHROMA	HUE
1	90.2	-4.2%	1.5%
2	90.9	-2.0%	3.7%
3	87.9	0.8%	5.5%
4	92.1	-0.9%	0.6%
5	93.0	1.5%	1.6%
6	92.2	3.9%	-0.2%
7	92.1	-0.3%	-2.0%
8	96.7	0.0%	-1.2%
9	92.5	-0.6%	3.7%
10	88.3	1.1%	7.0%
11	87.2	4.1%	7.4%
12	87.2	6.7%	-1.0%
13	88.2	3.8%	-7.2%
14	85.3	4.3%	-9.9%
15	90.9	-2.2%	-3.6%
16	83.4	-2.2%	-11.2%

**2000K only (2K4K)** | Rf: 84.3 | Rg: 96.9

COLOR VECTOR GRAPHIC

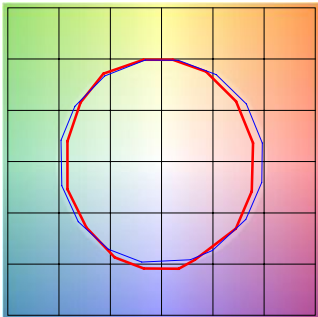

■ Test ■ Reference

HUE BIN	Rf	GRAPHIC SHIFTS %	
		CHROMA	HUE
1	80.3	-8.9%	1.7%
2	79.7	-7.0%	7.8%
3	78.9	-2.9%	10.0%
4	89.5	-0.5%	5.1%
5	94.4	0.7%	1.7%
6	92.1	2.4%	-0.3%
7	89.4	-2.4%	-5.9%
8	89.7	-6.4%	-0.2%
9	86.0	-4.9%	4.6%
10	81.8	-3.4%	9.3%
11	83.1	3.3%	9.7%
12	85.8	5.6%	3.3%
13	85.6	6.2%	-12.8%
14	61.7	-1.9%	-19.0%
15	79.7	-3.3%	-12.9%
16	78.1	-7.9%	-10.6%

**4000K only (2K4K)** | Rf: 89.6 | Rg: 99.1

COLOR VECTOR GRAPHIC

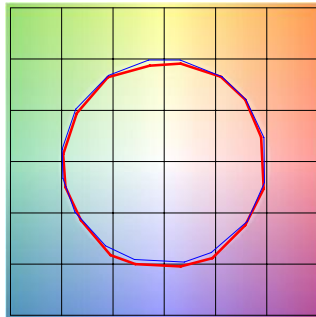

■ Test ■ Reference

HUE BIN	Rf	GRAPHIC SHIFTS %	
		CHROMA	HUE
1	91.3	-2.5%	1.0%
2	95.3	-0.5%	0.5%
3	94.3	-0.7%	1.1%
4	91.1	-3.4%	-1.1%
5	89.5	-5.6%	0.0%
6	94.6	-1.4%	1.3%
7	93.2	-3.0%	2.6%
8	91.3	-1.8%	4.6%
9	86.5	-0.9%	9.1%
10	83.3	-0.5%	9.5%
11	83.3	4.9%	9.0%
12	89.7	4.1%	1.7%
13	90.1	3.6%	-4.3%
14	93.4	5.2%	-2.1%
15	87.4	0.4%	-4.3%
16	86.6	0.4%	-6.1%

**2K4K (3000K)** | Rf: 90.2 | Rg: 101.4

COLOR VECTOR GRAPHIC

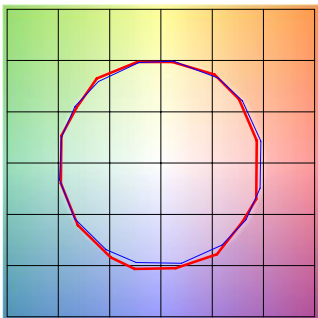

■ Test ■ Reference

HUE BIN	Rf	GRAPHIC SHIFTS %	
		CHROMA	HUE
1	90.9	-3.8%	1.3%
2	91.7	-1.9%	3.3%
3	88.7	0.7%	5.1%
4	92.4	-1.0%	0.7%
5	92.9	0.9%	1.7%
6	93.1	3.3%	-0.6%
7	91.0	-1.8%	-0.4%
8	97.0	0.2%	-1.1%
9	92.8	-0.5%	3.6%
10	88.3	1.0%	7.0%
11	87.1	3.8%	7.8%
12	87.6	6.5%	-0.3%
13	89.3	3.6%	-6.3%
14	86.1	4.5%	-9.1%
15	91.6	-1.9%	-3.1%
16	83.8	-1.5%	-11.2%



COMPANY		FIXTURE TYPE		DATE	
PROJECT		APPROVED BY			