

LIGHT CHANNEL .6 SURFACE MOUNT DIY (DO-IT-YOURSELF)

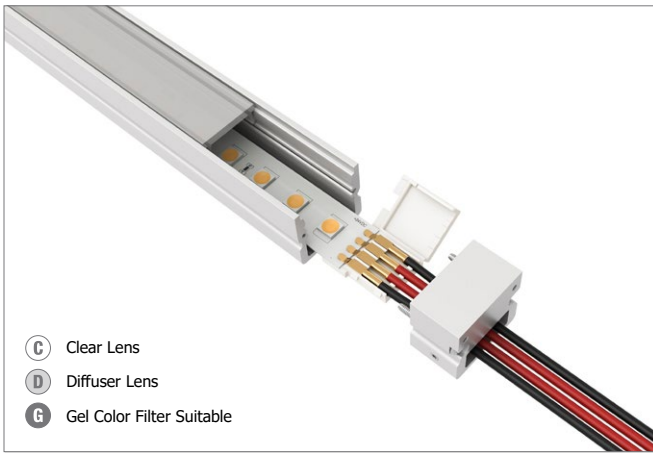

REV.05.10.17



- C** Clear Lens
- D** Diffuser Lens
- G** Gel Color Filter Suitable

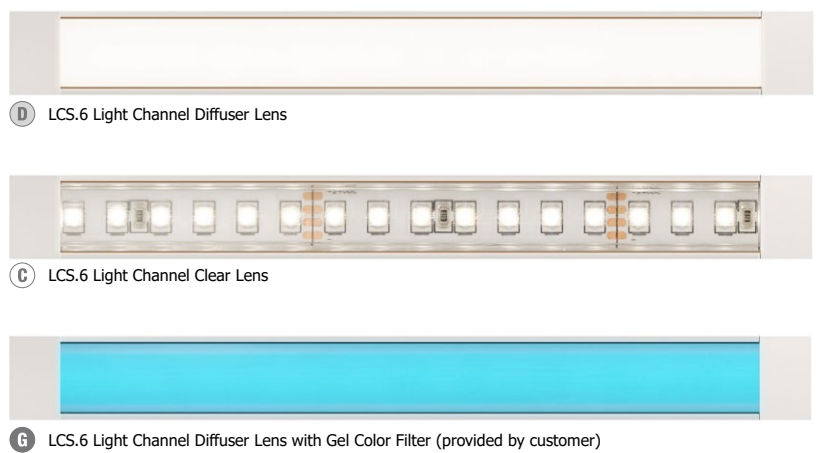

D LCS.6 Light Channel Diffuser Lens

C LCS.6 Light Channel Clear Lens

G LCS.6 Light Channel Diffuser Lens with Gel Color Filter (provided by customer)

Features & Benefits

- Cut and assemble in field
- Snap & Light Solderless Connections reduce labor during installation
- 24VDC LED Soft Strip offers excellent color-rendering inside a slim, paintable aluminum extrusion
- 4 oz of copper provides better heat dissipation, less voltage drop
- 5 color and 9 white color temperature options available
- Surface mount channel is sold in 2, 4, 5, 8, and 10 foot increments
- May be ordered in 22K-57K, Warm Dim, Tunable White, RGB, and Static Color
- White Diffuser Lens projects clean lines of light, eliminating LED dots
- Clear Lens provides maximum light levels and will show LED dots
- Clear and Diffuser Lenses can have Gel Color Filter (Gel Filter provided by customer www.leefilters.com)
- 7 LEDs per cutting increment provides 87.5% efficiency compared to 6 LEDs at only 75%. Solid State Power Supply offer 85-90% efficiency compared to magnetic at 80%. The combination of 7 LEDs and a Solid State Power Supply increases the efficiency up to 22%
- Low voltage up to 100 watt, Class 2 wiring, no need for conduit pipe
- 50-watt power supply fits in J Box (PS-60L-ELV-24VDC)
- 5 year warranty included

Applications

- Provides maximum light levels for task and general illumination
- Indoor only - Under/above cabinet, cove, and retail

Required Components (Sold Separately)

- Light Channel .6 Surface Mount and Lens (Mounting Clips included)
- End Caps (sold in pairs)
- 24VDC Light Channel Solderless Snap & Light Power/Jumper Connector
- 24VDC LED Soft Strip

Remote Power Supplies*, Dimmers & Controls (Sold Separately)

- Electronic Low Voltage Dimming (ELV)
- 0-10 Volt Dimming (0-10V)
- Dynamic Color Changing (DMX)
- Lutron Hi-Lume®

*In-Wall Mounting Kits available for select power supplies

Accessories/Replacement Parts (Sold Separately)

- Mounting Clips (Included with every 2 feet of Channel)
- Soft Strip Solderless Snap & Light Straight Joiner
- Solderless Light Channel Connectors

Light Channel .6 Surface Mount DIY System Overview

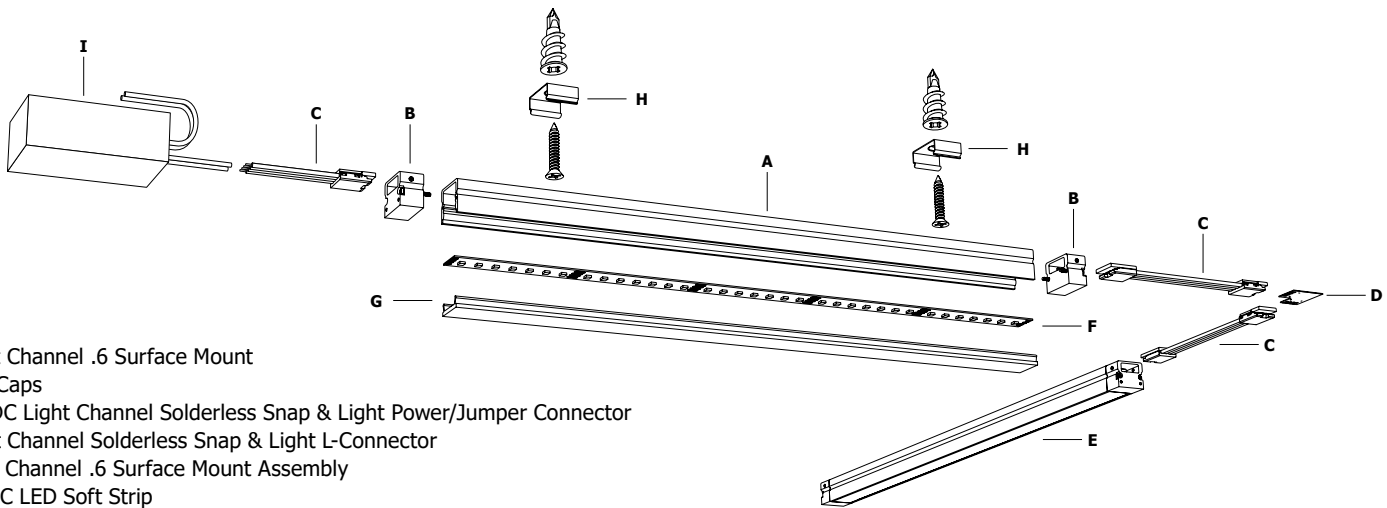

- A.** Light Channel .6 Surface Mount
- B.** End Caps
- C.** 24VDC Light Channel Solderless Snap & Light Power/Jumper Connector
- D.** Light Channel Solderless Snap & Light L-Connector
- E.** Light Channel .6 Surface Mount Assembly
- F.** 24VDC LED Soft Strip
- G.** Lens (Included with Light Channel)
- H.** Mounting Clips (Included with Light Channel)
- I.** Remote Power Supply (PS-60L-ELV-24VDC shown)

PROJECT:

FIXTURE TYPE:

DATE:

REQUIRED COMPONENTS: Select Light Channel .6 Surface Mount option, End Caps and Power Connector based on lighting design.



C LCS.6 Light Channel Clear Lens

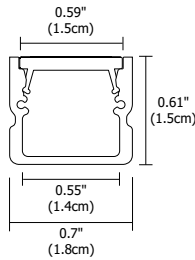

D LCS.6 Light Channel Diffuser Lens

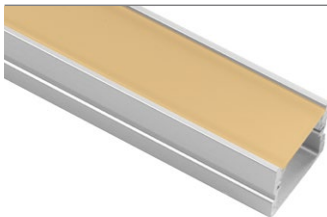
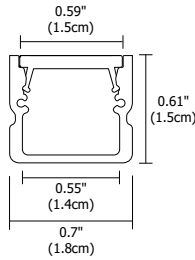

G LCS.6 Light Channel Diffuser Lens with Gel Color Filter (provided by customer)

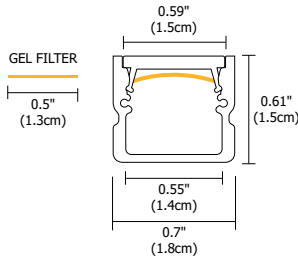

Light Channel .6 Surface Mount

Start the ordering process by selecting the desired length and lens option. Then order the LED Soft Strip, End Caps, Power Feed Joiner, and Jumper. At 0.61 inches tall the channel is low profile, made of paintable aluminum, and fits a 24VDC LED Soft Strip inside. The channel and lens may be cut in the field, and may be joined together using the Light Channel Snap & Light Solderless Jumper/Power Connector. Mounting Clips are included with every 2 feet of channel, and also be ordered separately as replacement parts. The Clear Lens provides maximum light levels and will show LED dots. The Diffuser Lens projects clean lines of light, eliminating LED dots. Both the Clear and Diffuser Lens are Gel Color Filter Suitable allowing for color personalization. Zircon LED Gel filters are recommended and can be purchased from the dealer www.leefilters.com. Gel filter life is 5,000 hours before needing to be changed.

System	Length in Feet	Lens	Finish
LCS.6	10FT	D	SA
LCS.6 Light Channel 0.6" Surface Mount	2FT 2 Feet 4FT 4 Feet 8FT 8 Feet 10FT 10 Feet 5FT 5 Feet	D Diffuser Lens C Clear Lens	SA Satin Aluminum

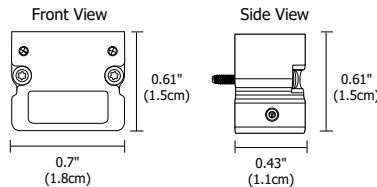
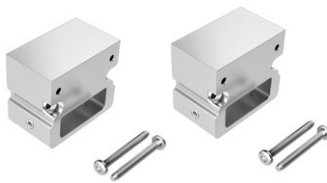

End Caps

End Caps are sold in pairs and provide a finished look at the end of a run as well as hold the required power connector. Typically one order of End Caps per run will suffice, however additional End Caps may be required if the lighting design requires cutting the channel.

System	Product	Type	Finish
LCS.6	SLC	CA	SA
LCS.6 Light Channel 0.6" Surface Mount	SLC Snap and Light Connector	CA End Caps	SA Satin Aluminum

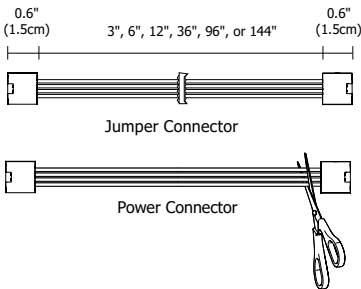

24VDC Light Channel Solderless Snap & Light Jumper/Power Connector

Use as a power connector is required, and use as a jumper connector is optional. Join 2 cut sections of LED Soft Strip end to end within the channel. Solderless connections provide easy installation and are compatible with Solderless Light Channel Connector accessories. To use as a power connector cut and strip the wires.

System	Product	Length
LC	SLC	3IN
LC Light Channel	SLC Solderless Snap & Light Jumper/Power Connector	3IN 3 Inches 6IN 6 Inches 12IN 12 Inches 36IN 36 Inches 96IN 96 Inches 144IN 144 Inches

ACCESSORIES: Order based on lighting design or as replacement parts.

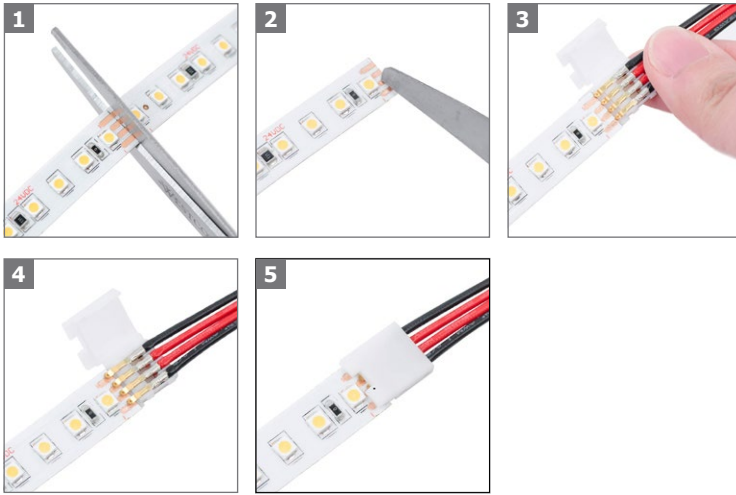

Light Channel Solderless Snap & Light Connectors: Allow easy cutting and rejoining of the LED Soft Strip at any point within a Light Channel. Light Channel Solderless Snap & Light Connectors provide a tightly sealed connection, reducing labor during installation. The gold plated connections provide better connectivity without oxidation.

1. Cut in the middle of the joining contacts
2. Remove the protective coating from the contacts
3. Place the LED Soft Strip end under the plastic guide and push it under the snap contacts
4. Close the cover
5. Snap the cover to secure in place

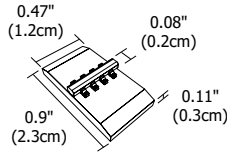

Soft Strip Solderless Snap & Light Straight Joiner

Joins 2 sections of LED Soft Strip in the channel. Used when replacing a section of LED Soft Strip.

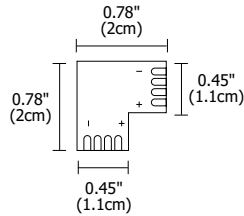
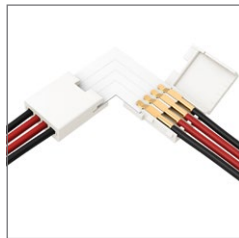
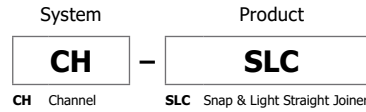

Light Channel Solderless Snap & Light L-Connector

Conducts power to 2 sections of LED Soft Strip within the Light Channel. Requires Light Channel Solderless Snap & Light Power/Jumper Connector (sold separately) for use.

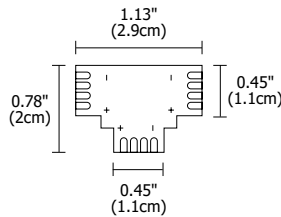
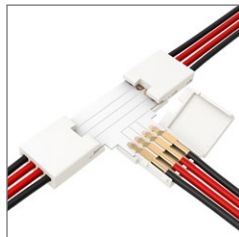
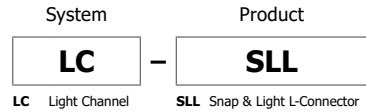

Light Channel Solderless Snap & Light T-Connector

Conducts power to 3 sections of LED Soft Strip within the Light Channel. Requires Light Channel Solderless Snap & Light Power/Jumper Connector (sold separately) for use.

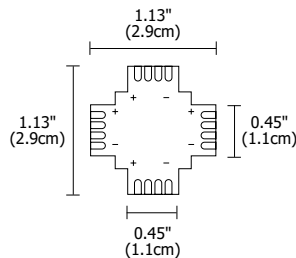
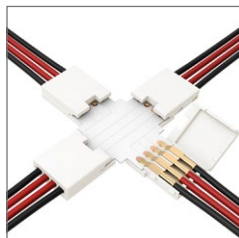
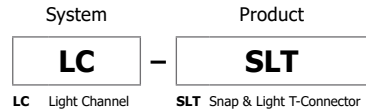

Light Channel Solderless Snap & Light X-Connector

Conducts power to 4 sections of LED Soft Strip within the Light Channel. Requires Light Channel Solderless Snap & Light Power/Jumper Connector (sold separately) for use.

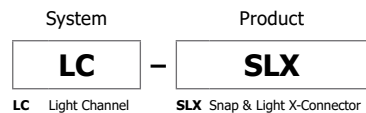

ACCESSORIES: Order based on lighting design or as replacement parts.



LCS.5-MCL

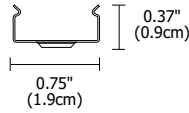

LCS.5-MCL

Mounting Clips

LC-MCL mounting clips are provided with every two feet of Light Channel and may be ordered separately as replacement parts. The LC-MCL-075 rotates Light Channel up to 75 degrees. LC-MCL-90 mounts Light Channel at a 90 degree angle.

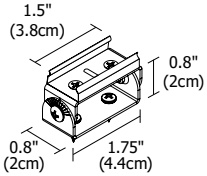

LCS.5-MCL-075

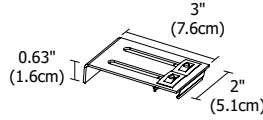

LCS.5-MCL-90

System	Product	Type
LCS.6	MCL	Standard (Leave Blank)
LCS.6 Light Channel 0.6" Surface Mount	MCL Mounting Clip	075 Adjusts 0-75° 90 Adjusts 90°

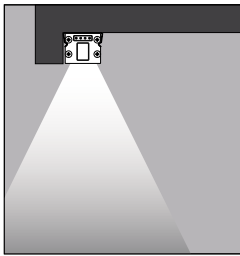

SHOWN WITH LCS.6-MCL

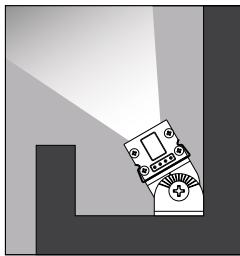

SHOWN WITH LCS.6-MCL-075

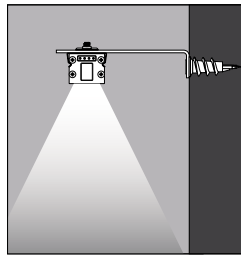

SHOWN WITH LCS.6-MCL-90



4RD-WH

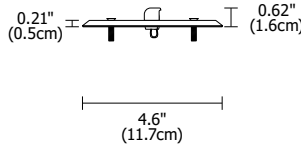
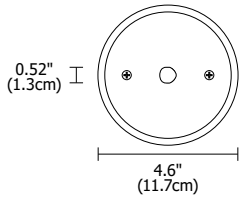

3RE-WH

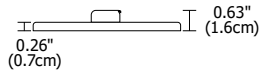
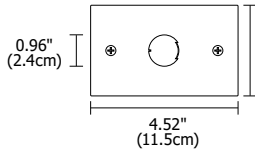

Canopy Cover & Splice Box

Use for remote located power supply. The 3 inch rectangle or 4 inch round white canopy covers the electrical box and feeds wires for Light Channel. The Splice Box provides a safe enclosure for low voltage connections.

Product	Finish
3RE	WH
3RE 3 Inch Rectangle Canopy Cover	WH White
4RD 4 Inch Round Canopy Cover	
1RB 1 Inch Rectangle Splice Box	



1RB-WH

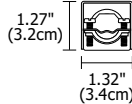
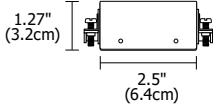

LIGHT CHANNEL .6 SURFACE MOUNT DIY (DO-IT-YOURSELF)



REV.05.10.17

REQUIRED COMPONENTS: Use the comparison chart below to select the desired 24VDC LED Soft Strip to install within Light Channel .6 Surface Mount.

ORDERING CODE	SS2P	SS4P	SS2C	SS5C	SS7C	SS5C	SS5C	SS5	SS5
COLOR TYPE	Static White	Static White	Static White	Static White	Static White	Warm Dim	Tunable White (2K4K)	Dynamic Color (RGB)	Static Color
GRADE	Economy	Economy	Economy Premium	Economy Premium	Economy Premium	Commercial	Commercial	Special Application	Special Application
WATTAGE PER FOOT*	2.3w	3.8w	2.5w	4.4w	7.3w	5w	4.8w	5w	5w
AVAILABLE COLOR TEMPERATURES & CRI	2700K - 84 3000K - 85	2700K - 84 3000K - 85	2200K - 85+ 2700K - 95+ 3000K - 95+ 3500K - 85+ 4000K - 84 5700K - 84	2200K - 85+ 2700K - 95+ 3000K - 95+ 3500K - 85+ 4000K - 84 5700K - 84	2200K - 85+ 2700K - 95+ 3000K - 95+ 3500K - 85+ 4000K - 84 5700K - 84	2700K - 95 3000K - 95 (Warm Dim)	2000K - 4000K (Tunable White) - 90	Red, Green, and Blue	Red Green Blue Amber
CLEAR LENS LUMENS PER FOOT	27K - 84lm/ft	27K - 84lm/ft	22K - 121.13lm/ft	22K - 198.99lm/ft	22K - 300.38lm/ft	27K - 240lm/ft	20K + 40K (30K) XXlm/ft	Red - XXlm/ft	Red - XXlm/ft
			27K - 147.77lm/ft	27K - 242.77lm/ft	27K - 366.46lm/ft		20K - XXlm/ft	Green - XXlm/ft	Green - XXlm/ft
	30K - 85lm/ft	30K - 85lm/ft	30K - 161.50lm/ft	30K - 265.32lm/ft	30K - 400.50lm/ft	30K - 261lm/ft	40K - XXlm/ft	Blue - XXlm/ft	Blue - XXlm/ft
			35K - 184.92lm/ft	35K - 303.79lm/ft	35K - 458.57lm/ft		40K - XXlm/ft	RGB - XXlm/ft	Amber - XXlm/ft
CLEAR LENS LUMENS PER WATT	27K - XXlm/w	27K - XXlm/w	22K - 48.45lm/w	22K - 45.23lm/w	22K - 40.05lm/w	27K - 55lm/w	20K + 40K (30K) XXlm/w	Red - XXlm/w	Red - XXlm/w
			27K - 59.11lm/w	27K - 55.17lm/w	27K - 48.86lm/w		20K - XXlm/w	Green - XXlm/w	Green - XXlm/w
	30K - XXlm/w	30K - XXlm/w	30K - 64.60lm/w	30K - 60.30lm/w	30K - 53.40lm/w	30K - 60lm/w	40K - XXlm/w	Blue - XXlm/w	Blue - XXlm/w
			35K - 73.97lm/w	35K - 69.04lm/w	35K - 61.14lm/w		40K - XXlm/w	RGB - XXlm/w	Amber - XXlm/w
DIFFUSER LENS LUMENS PER FOOT	27K - XXXlm/ft	27K - XXXlm/ft	22K - 90.00lm/ft	22K - 148.50lm/ft	22K - 241.88lm/ft	27K - 195lm/ft	20K + 40K (30K) XXlm/ft	Red - XXlm/ft	Red - XXlm/ft
			27K - 109.80lm/ft	27K - 181.17lm/ft	27K - 295.09lm/ft		20K - XXlm/ft	Green - XXlm/ft	Green - XXlm/ft
	30K - XXXlm/ft	30K - XXXlm/ft	30K - 137.40lm/ft	30K - 226.71lm/ft	30K - 369.26lm/ft	30K - 205lm/w	40K - XXlm/ft	Blue - XXlm/ft	Blue - XXlm/ft
			40K - 149.40lm/ft	40K - 246.51lm/ft	40K - 401.51lm/ft		40K - XXlm/ft	RGB - XXlm/ft	Amber - XXlm/ft
DIFFUSER LENS LUMENS PER WATT	27K - XXlm/w	27K - XXlm/w	22K - 36.00lm/w	22K - 33.75lm/w	22K - 32.25lm/w	27K - 39lm/w	20K + 40K (30K) XXlm/w	Red - XXlm/w	Red - XXlm/w
			27K - 43.92lm/w	27K - 41.18lm/w	27K - 39.35lm/w		20K - XXlm/w	Green - XXlm/w	Green - XXlm/w
	30K - XXlm/w	30K - XXlm/w	30K - 48.00lm/w	30K - 45.00lm/w	30K - 43.00lm/w	30K - 41lm/w	40K - XXlm/w	Blue - XXlm/w	Blue - XXlm/w
			35K - 54.96lm/w	35K - 51.53lm/w	35K - 49.24lm/w		40K - XXlm/w	RGB - XXlm/w	Amber - XXlm/w
NUMBER OF LEDS PER FOOT	35	35	35	35	35	35 & 35 (70 total)	35 & 35 (70 total)	35	18
CUTTING INCREMENTS	2.4"	2.4"	2.4"	2.4"	2.4"	3"	2.4"	2.4"	2.4"
MAXIMUM LENGTH WITH 100 WATT, CLASS 2 POWER SUPPLY	40 FT	25 FT	40 FT	20 FT	12 FT	20 FT	20 FT	20 FT	40 FT
LED DISTANCE	0.34"	0.34"	0.34"	0.34"	0.34"	0.38" (same colors) 0.15" (warm to cool) 0.22" (cool to warm)	0.34" (same colors) 0.15" (warm to cool) 0.2" (cool to warm)	0.34"	0.34"
DIMMING TYPE	ELV 0-10V	ELV 0-10V	ELV 0-10V	ELV 0-10V	ELV 0-10V	ELV	ELV 0-10V DMX	DMX	DMX
LAMP LIFE (HOURS)	50,000	50,000	50,000	50,000	50,000	50,000	50,000	50,000	50,000

REQUIRED COMPONENTS: Select 24VDC LED Soft Strip based on desired color temperature and application.

To Solid State Power Supply with 85-90% efficiency compared to magnetic at only 80%

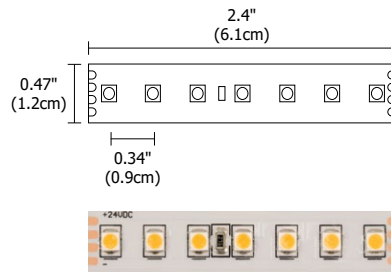
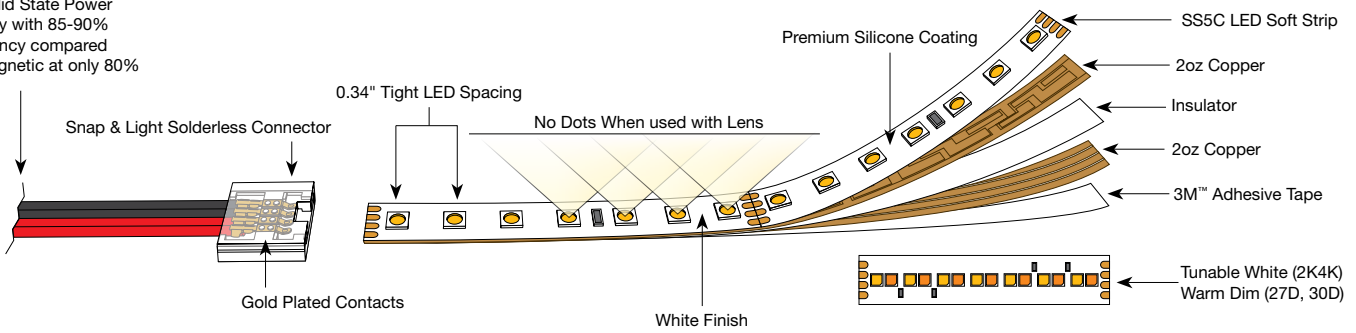

Economy Premium Static White Soft Strip

Consumes 2.3 watts per foot (SS2P) and 3.8 watts per foot (SS4P) is available in two color temperatures. SS2P and SS4P Soft Strip use ELV and 0-10V power supplies.

System	Voltage	Length in Feet	Color Temperature
SS2P	24V	8	27K
SS2P LED Soft Strip Economy Premium 2.3 watts per foot	24V 24 Volt	1-40 1 - 40 feet (SS2P)	27K 2700K Very Warm White
SS4P LED Soft Strip Economy Premium 3.8 watts per foot		1-25 1 - 25 feet (SS4P)	30K 3000K Warm White

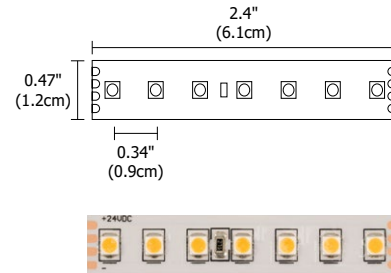

Commercial Static White Soft Strip

Consumes 2.5 watts per foot (SS2C), 4.4 watts per foot (SS5C), and 7.3 watts per foot (SS7C) and is available in six color temperatures. SS2C, SS5C, and SS7C Soft Strips use ELV and 0-10V power supplies.

System	Voltage	Length in Feet	Color Temperature
SS2C	24V	40	27K
SS2C LED Soft Strip Commercial 2.5 watts per foot	24V 24 Volt	1-40 1 - 40 feet (SS2C)	22K 2200K Amber White
SS5C LED Soft Strip Commercial 4.4 watts per foot		1-20 1 - 20 feet (SS5C)	27K 2700K Very Warm White
SS7C LED Soft Strip Commercial 7.3 watts per foot		1-12 1 - 12 feet (SS7C)	30K 3000K Warm White
			35K 3500K Neutral White
			40K 4000K Cool White
			57K 5700K Daylight White

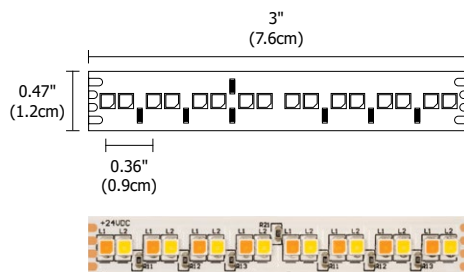

Commercial Warm Dim Soft Strip

Consumes 5 watts per foot and is available in two color temperatures that dim down to 2200K. SS5C Soft Strip Warm Dim uses ELV power supplies.

System	Voltage	Length in Feet	Color Temperature
SS5C	24V	20	27D
SS5C LED Soft Strip Commercial 5 watts per foot	24V 24 Volt	1-20 1 - 20 feet	27D 2700K Warm Dim
			30D 3000K Warm Dim

PROJECT:

FIXTURE TYPE:

DATE:

REQUIRED COMPONENTS: Select 24VDC LED Soft Strip based on desired color temperature and application.

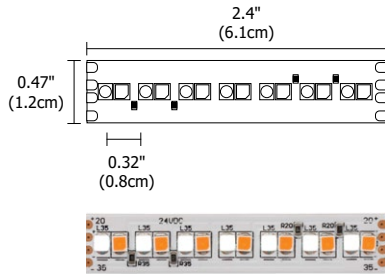

Commercial Tunable White (2K4K)

Consumes 4.8 watts per foot and provides variable color temperatures ranging from candlelight (2000K) to cool white (4000K). SS5C Soft Strip Tunable White uses ELV, 0-10V, and DMX power supplies.

System	Voltage	Length in Feet	Color Temperature
SS5C	24V	20	2K4K
SS5C LED Soft Strip Commercial 4.8 watts per foot	24V 24 Volt	1-20 1 - 20 feet	2K4K Tunable White 2000K-4000K

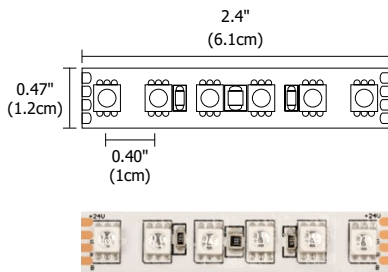

Special Application Dynamic Color (RGB)

Consumes 5 watts per foot and provides dynamic color changing effects with red, green, and blue LEDs. SS5 Soft Strip uses DMX power supplies.

System	Voltage	Length in Feet	Color Temperature
SS5	24V	20	RGB
SS5 LED Soft Strip Special Application 5 watts per foot	24V 24 Volt	1-20 1 - 20 feet	RGB Red, Green, & Blue

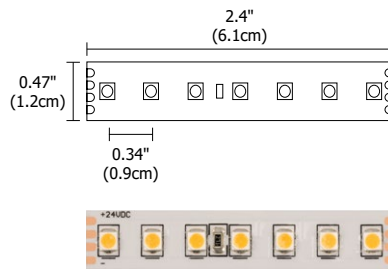

Special Application Static Color

Consumes 4.8 watts per foot and provides static colors with red, green, blue, and amber LEDs. SS5 Soft Strip uses ELV and 0-10V power supplies.

System	Voltage	Length in Feet	Color Temperature
SS5	24V	36	AAA
SS5 LED Soft Strip Special Application 4.8 watts per foot	24V 24 Volt	1-36 1 - 36 feet	AAA Amber GGG Green BBB Blue RRR Red

PROJECT:

FIXTURE
TYPE:

DATE:

LIGHT CHANNEL .6 SURFACE MOUNT DIY (DO-IT-YOURSELF)



REV.05.10.17

REQUIRED COMPONENTS: 24VDC ELV Compatible Power Supplies.

ELECTRONIC LOW-VOLTAGE (ELV) POWER SUPPLIES & RECOMMENDED DIMMERS [†]				
ORDERING CODES	PS-60L-ELV-24VDC	PSB-60W-ELV-24VDC	PSB-2X60W-ELV-24VDC	PSB-100W-ELV-24VDC
SPECIFICATIONS				
MAXIMUM LOAD	60W-NIC, 50W-IC (FITS IN JBOX)	60W	2X60W	96W
INPUT VOLTAGE	120VAC	120VAC	120VAC	120VAC
OUTPUT VOLTAGE	24VDC	24VDC	24VDC	24VDC
DIMENSIONS	2.25" X 1.25" X 0.83"	8.125" X 2" X 1.75"	12.15" X 6.48" X 2.18"	9.25" X 3.5" X 2"
CLASSIFICATION	CLASS 2	CLASS 2	CLASS 2	CLASS 2
IN WALL MOUNTING	N/A	PSB-60W-ELV-24VDC-IW	PSB-2X60W-ELV-24VDC-IW	PSB-100W-ELV-24VDC-IW
DIMMING AND CONTROLS				
LUTRON DIVA: DVELV-300P	•	•	•	•
LUTRON SKYLARK: SELV-300P	•	•	•	•
LUTRON RADIO RA2: RRD-6NA	N/A	•	•	•
LUTRON MAESTRO: MAELV-600	•	•	•	•
LEGRAND ADORNE: ADTP-703TUM4	N/A	•	•	•

ELECTRONIC LOW-VOLTAGE (ELV) POWER SUPPLIES & RECOMMENDED DIMMERS [†]			
ORDERING CODES	PSB-2X100W-ELV-24VDC	PSB-3X100W-ELV-24VDC	PSB-4X100W-ELV-24VDC
SPECIFICATIONS			
MAXIMUM LOAD	2X96W	3X96W	4X96W
INPUT VOLTAGE	120VAC	120VAC	120VAC
OUTPUT VOLTAGE	24VDC	24VDC	24VDC
DIMENSIONS	12.15" X 6.48" X 2.18"	14" X 10" X 3"	17" X 13" X 3"
CLASSIFICATION	CLASS 2	CLASS 2	CLASS 2
IN WALL MOUNTING	PSB-2X100W-ELV-24VDC-IW	N/A	N/A
DIMMING AND CONTROLS			
LUTRON DIVA: DVELV-300P	•	•	•
LUTRON SKYLARK: SELV-300P	•	•	•
LUTRON RADIO RA2: RRD-6NA	•	•	•
LUTRON MAESTRO: MAELV-600	•	•	•
LEGRAND ADORNE: ADTP-703TUM4	•	•	•

[†]22K - 57K color temperatures are compatible with 0-10V, ELV, and Lutron Hi-lume® Power Supplies. Warm Dim (27D, 30D) color temperatures are only compatible with ELV power supplies. Tunable White (2K4K) color temperature is compatible with 0-10V, ELV, DMX, and Lutron Hi-lume® Power Supplies. Dynamic Color (RGB, RGB+W) and Static Color (Amber, Blue, Green, or Red) are compatible with DMX Power Supplies.

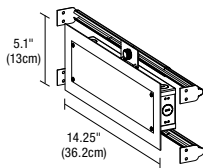

5.1 x 14.25 inch In-Wall Mounting Kit: Includes power supply, box cover and stud hangers for installing Junction Box in wall. Select "IW" in the options section of compatible power supply ordering codes if an In-Wall Mounting Kit is needed.

Ordering Codes: PSB-60W-ELV-24VDC-IW, PSB-100W-ELV-24VDC-IW

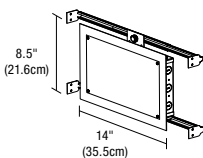

8.5 x 14 inch In-Wall Mounting Kit: Includes power supply, box cover and stud hangers for installing Junction Box in wall. Select "IW" in the options section of compatible power supply ordering codes if an In-Wall Mounting Kit is needed.

Ordering Codes: PSB-2x60W-ELV-24VDC-IW, PSB-2x100W-ELV-24VDC-IW



LIGHT CHANNEL .6 SURFACE MOUNT DIY (DO-IT-YOURSELF)



REV.05.10.17

REQUIRED COMPONENTS: 24VDC 0-10V Compatible Power Supplies.

0-10 VOLT (010) POWER SUPPLIES & RECOMMENDED DIMMERS [†]				
ORDERING CODES	PSB-25W-010-24VDC	PSB-60W-010-24VDC	PSB-96W-010-24VDC	PSB-2X96W-010-24VDC
SPECIFICATIONS				
MAXIMUM LOAD	25W	60W	96W	2X96W
INPUT VOLTAGE	120VAC	120-277VAC	120-277VAC	120-277VAC
OUTPUT VOLTAGE	24VDC	24VDC	24VDC	24VDC
DIMENSIONS	12.4" X 3.12" X 2.18"	12.4" X 3.12" X 2.18"	12.4" X 3.12" X 2.18"	12.15" X 6.48" X 2.18"
CLASSIFICATION	CLASS 2	CLASS 2	CLASS 2	CLASS 2
IN WALL MOUNTING	PSB-25W-010-24VDC-IW	PSB-60W-010-24VDC-IW	PSB-96W-010-24VDC-IW	PSB-2X96W-010-24VDC-IW
DIMMING AND CONTROLS				
PHILIPS SUNRISE: SR1200ZTUNV	•	•	•	•
LUTRON DIVA:: DVTW-WH	•	•	•	•
LUTRON NOVA T: NTSTV-DV-XX	•	•	•	•
LUTRON GRAFIX EYE QS: QSGRJ-XP	•	•	•	•
LUTRON RADIO RA2: RRD-10ND	•	•	•	•
LEVITON: LEV40050	•	•	•	•
LEVITON IP710-LFZ	•	•	•	•
LEGRAND: ADPD4FBL3P2W4	•	•	•	•

0-10 VOLT (010) POWER SUPPLIES & RECOMMENDED DIMMERS [†]		
ORDERING CODES	PSB-3X96W-010-24VDC	PSB-4X96W-010-24VDC
SPECIFICATIONS		
MAXIMUM LOAD	3X96W	4X96W
INPUT VOLTAGE	120-277VAC	120-277VAC
OUTPUT VOLTAGE	24VDC	24VDC
DIMENSIONS	14" X 10" X 3"	17" X 13" X 3"
CLASSIFICATION	CLASS 2	CLASS 2
IN WALL MOUNTING	N/A	N/A
DIMMING AND CONTROLS		
PHILIPS SUNRISE: SR1200ZTUNV	•	•
LUTRON DIVA: DVTW-WH	•	•
LUTRON NOVA T: NTSTV-DV-XX	•	•
LUTRON GRAFIX EYE QS: QSGRJ-XP	•	•
LUTRON RADIO RA2: RRD-10ND	•	•
LEVITON: LEV40050	•	•
LEVITON IP710-LFZ	•	•
LEGRAND: ADPD4FBL3P2W4	•	•

[†]22K - 57K color temperatures are compatible with 0-10V, ELV, and Lutron Hi-lume® Power Supplies. Warm Dim (27D, 30D) color temperatures are only compatible with ELV power supplies. Tunable White (2K4K) color temperature is compatible with 0-10V, ELV, DMX, and Lutron Hi-lume® Power Supplies. Dynamic Color (RGB, RGB+W) and Static Color (Amber, Blue, Green, or Red) are compatible with DMX Power Supplies.

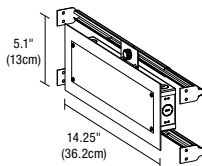

5.1 x 14.25 inch In-Wall Mounting Kit: Includes power supply, box cover and stud hangers for installing Junction Box in wall. Select "IW" in the options section of compatible power supply ordering codes if an In-Wall Mounting Kit is needed.

Ordering Codes: PSB-25W-010-24VDC-IW, PSB-60W-010-24VDC-IW, PSB-96W-010-24VDC-IW

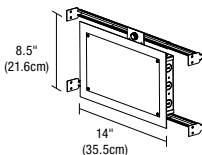

8.5 x 14 inch In-Wall Mounting Kit: Includes power supply, box cover and stud hangers for installing Junction Box in wall. Select "IW" in the options section of compatible power supply ordering codes if an In-Wall Mounting Kit is needed.

Ordering Codes: PSB-2X96W-010-24VDC-IW











LIGHT CHANNEL .6 SURFACE MOUNT DIY (DO-IT-YOURSELF)



REV.05.10.17

REQUIRED COMPONENTS: 24VDC DMX Compatible Power Supplies.

DYNAMIC COLOR CHANGING (DMX) POWER SUPPLIES & RECOMMENDED CONTROLLERS ¹					
ORDERING CODES	PS-25W-24VDC	PSB-100W-24VDC-RGB	PSB-2X100W-24VDC-RGB	PSB-3X100W-24VDC-RGB	PSB-4X100W-24VDC-RGB
					
SPECIFICATIONS					
MAXIMUM LOAD	25W	100W	2X100W	3X100W	4X100W
INPUT VOLTAGE	100-277VAC	120-277VAC	120-277VAC	120-277VAC	120-277VAC
OUTPUT VOLTAGE	24VDC	24VDC	24VDC	24VDC	24VDC
DIMENSIONS	5.25" X 1.57" X 1.2"	12.14" X 6.48" X 2.18"	14" X 10" X 3"	17" X 13" X 3"	17" X 13" X 3"
CLASSIFICATION	CLASS 2	CLASS 2	CLASS 2	CLASS 2	CLASS 2
IN WALL MOUNTING	N/A	PSB-100W-24VDC-RGB-IW	N/A	N/A	N/A
DIMMING AND CONTROLS					
TOUCH SCREEN CONTROLLER (CTP)	N/A	•	•	•	•
COLOR DIAL CONTROLLER (CDP)	N/A	•	•	•	•
DMX 1 ZONE RGBW TOUCH CONTROLLER (CDMX1-RGBW)	N/A	•	•	•	•
TUNABLE WHITE TOUCH CONTROLLER (CDMX1-2XK)	N/A	•	•	•	•

DYNAMIC COLOR CHANGING (DMX) POWER SUPPLIES & RECOMMENDED CONTROLLERS ¹			
ORDERING CODES	PSB-200W-24VDC-RGB	PSB-400W-24VDC-RGB	PSB-100W-24VDC-DALI
			
SPECIFICATIONS			
MAXIMUM LOAD	200W	400W	100W
INPUT VOLTAGE	120-240VAC	120-240VAC	120-277VAC
OUTPUT VOLTAGE	24VDC	24VDC	24VDC
DIMENSIONS	12" X 8" X 4.3"	12" X 8" X 6.5"	12.14" X 6.48" X 2.18"
CLASSIFICATION	UL1598*	UL1598*	CLASS 2
IN WALL MOUNTING	N/A	N/A	PSB-100W-24VDC-DALI-IW
DIMMING AND CONTROLS			
TOUCH SCREEN CONTROLLER (CTP)	•	•	•
COLOR DIAL CONTROLLER (CDP)	•	•	•
DMX 1 ZONE RGBW TOUCH CONTROLLER (CDMX1-RGBW)	•	•	•
TUNABLE WHITE TOUCH CONTROLLER (CDMX1-2XK)	•	•	•
DALI COMPATIBLE	•	•	•

¹24K - 57K color temperatures are compatible with 0-10V, ELV, and Lutron Hi-lume® Power Supplies. Warm Dim (27D, 30D) color temperatures are only compatible with ELV power supplies. Tunable White (2K4K) color temperature is compatible with 0-10V, ELV, DMX, and Lutron Hi-lume® Power Supplies. Dynamic Color (RGB, RGB+W) and Static Color (Amber, Blue, Green, or Red) are compatible with DMX Power Supplies.

*24VDC wires must be in conduit from Remote Power Supply to JBOX.

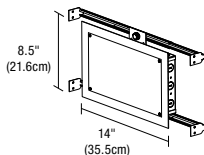

8.5 x 14 inch In-Wall Mounting Kit: Includes power supply, box cover and stud hangers for installing Junction Box in wall. Select "IW" in the options section of compatible power supply ordering codes if an In-Wall Mounting Kit is needed.

Ordering Codes: PSB-100W-24VDC-RGB-IW, PSB-100W-24VDC-RGB-IW



REQUIRED COMPONENTS: 24VDC Lutron Compatible Power Supply.

LUTRON HI-LUME® PREMIER .1% ECOSYSTEM® 3-WIRE POWER SUPPLY & RECOMMENDED CONTROLLERS ¹	
ORDERING CODES	L3D0-96W24V-U 
SPECIFICATIONS	
MAXIMUM LOAD	96W
INPUT VOLTAGE	120-277VAC
OUTPUT VOLTAGE	24VDC
DIMENSIONS	10.5" X 5.5" X 2"
CLASSIFICATION	CLASS 2
DIMMING AND CONTROLS	
RADIO RA2	•
HOMEWORKS QS	•
PHPM-3F-120	•
PHPM-3F-DV	•
BCI-0-10	•

¹22K - 57K color temperatures are compatible with 0-10V, ELV, and Lutron Hi-lume® Power Supplies. Warm Dim (27D, 30D) color temperatures are only compatible with ELV power supplies. Tunable White (2K4K) color temperature is compatible with 0-10V, ELV, DMX, and Lutron Hi-lume® Power Supplies. Dynamic Color (RGB, RGB+W) and Static Color (Amber, Blue, Green, or Red) are compatible with DMX Power Supplies.

PROJECT: _____

FIXTURE TYPE: _____

DATE: _____

WIRING DIAGRAM: Electronic Low Voltage (ELV) dimming for Light Channel .6 Surface Mount.

Power Supply: 120VAC input, 24VDC 96 watt output PSB-100W-ELV-24VDC

Dimming: Dimmable with low voltage electronic dimmer using power supply above. See power supply spec sheet for additional details. Lutron: Diva DVELV-300P; Skylark SELV-300P; Maestro MAELV-600 dimmers are recommended.

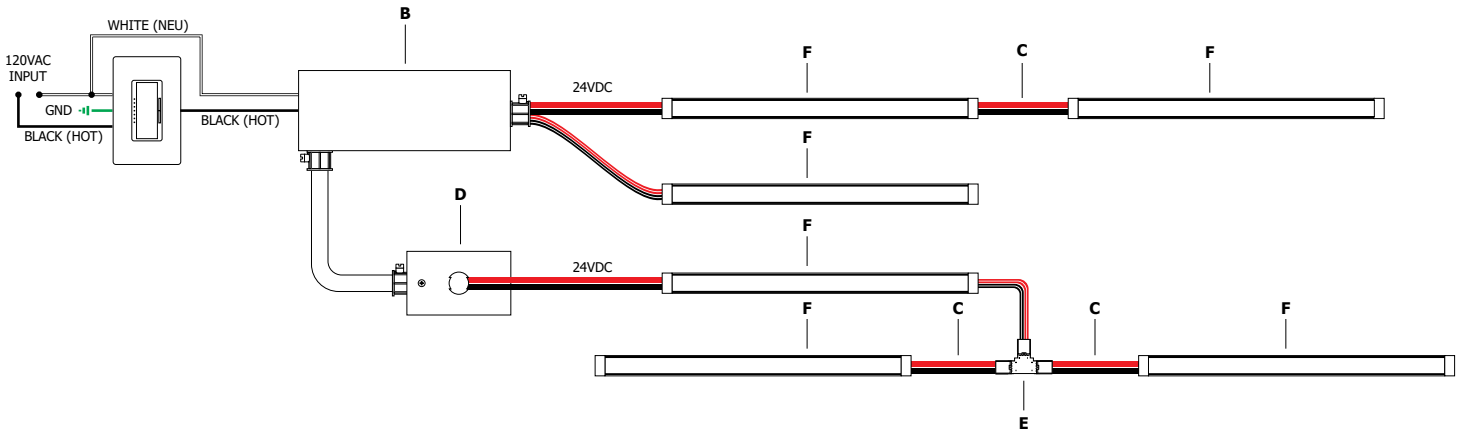

- A. ELV Dimmer
- B. 100W 24VDC Power Supply
- C. 24VDC Light Channel Solderless Snap & Light Power/Jumper Connector
- D. 3" Rectangle Canopy Cover
- E. Light Channel Solderless Snap & Light T Connector (LC-SLT)
- F. DIY Light Channel .6 Surface Mount

WIRING DIAGRAM: Electronic Low Voltage (ELV) dimming for Light Channel .6 Surface Mount.

Power Supply: 120VAC input, 24VDC 96 watt output PSB-100W-ELV-24VDC, 120VAC input, 24VDC 60 watt output PSB-60W-ELV-24VDC, and 120VAC input, 24VDC 40 watt output PS-40W-ELV-24VDC

Dimming: Dimmable with low voltage electronic dimmer using power supply above. See power supply spec sheet for additional details. Lutron: Diva DVELV-300P; Skylark SELV-300P; Maestro MAELV-600 dimmers are recommended.

PS-60L-ELV-24VDC

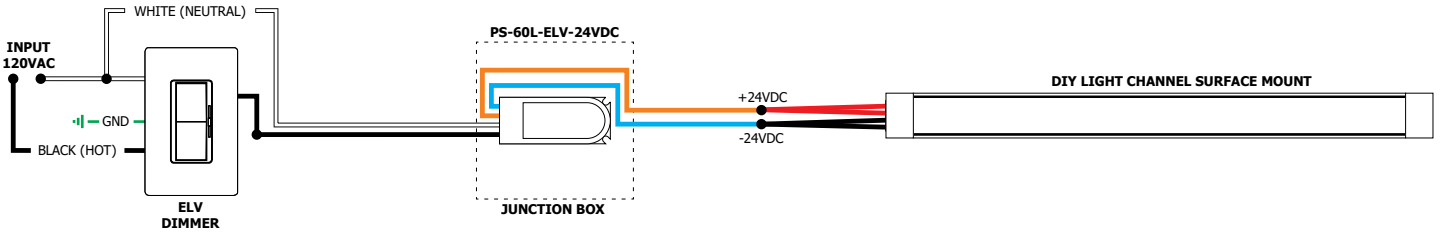

PSB-60W-ELV-24VDC

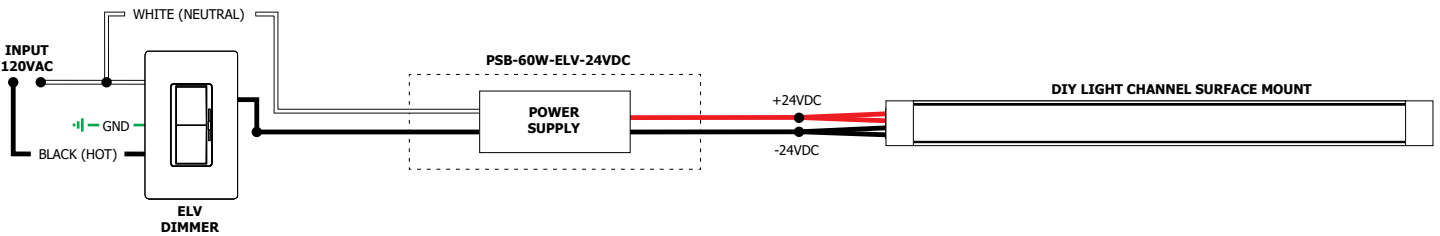

PSB-100W-ELV-24VDC

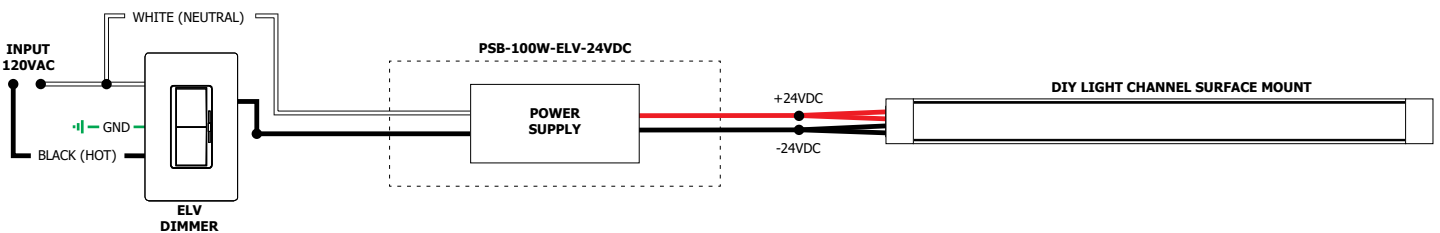

PROJECT: _____

FIXTURE TYPE: _____

DATE: _____

LIGHT CHANNEL .6 SURFACE MOUNT DIY (DO-IT-YOURSELF)



REV.05.10.17

TM-30-15 DATA: The data below is for SS2C, SS5C, and SS7C bare LED Soft Strips. Consistent color temperatures throughout a single strip and among multiple strips is possible through a 3 phase binning process in which each order is inspected with a color meter to ensure uniformity.

2200K | Rf: 83.9 | Rg: 94.9 | CRI: 85+

COLOR VECTOR GRAPHIC

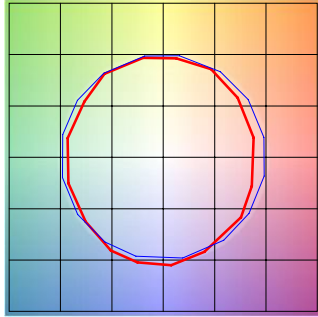

■ Test ■ Reference

HUE BIN	Rf	GRAPHIC SHIFTS %	
		CHROMA	HUE
1	77.6	-10.0%	1.8%
2	80.7	-7.5%	7.0%
3	79.5	-2.9%	8.9%
4	90.5	-3.1%	2.4%
5	93.9	-1.3%	1.9%
6	91.9	-0.9%	-0.2%
7	87.6	-6.3%	-2.7%
8	90.5	-5.4%	2.7%
9	83.8	-4.7%	6.5%
10	81.2	-2.5%	10.0%
11	83.3	3.9%	9.4%
12	86.4	5.6%	2.6%
13	86.2	4.5%	-12.4%
14	64.3	-1.0%	-21.9%
15	85.1	-4.4%	-7.5%
16	75.0	-9.9%	-12.0%

2700K | Rf: 87.7 | Rg: 96.1 | CRI: 95+

COLOR VECTOR GRAPHIC

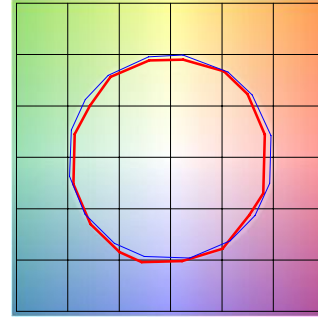

■ Test ■ Reference

HUE BIN	Rf	GRAPHIC SHIFTS %	
		CHROMA	HUE
1	86.4	-5.6%	2.3%
2	89.7	-3.3%	3.1%
3	90.5	-1.5%	3.8%
4	90.0	-4.3%	1.1%
5	92.9	-3.7%	0.2%
6	93.5	-2.5%	-0.8%
7	86.3	-7.2%	2.5%
8	90.7	-4.0%	3.2%
9	85.2	-2.4%	8.1%
10	81.7	0.9%	10.8%
11	85.4	4.5%	8.9%
12	88.7	5.7%	-1.4%
13	88.3	1.3%	-7.9%
14	85.1	2.4%	-10.4%
15	88.1	-4.8%	-2.7%
16	81.7	-4.3%	-10.9%

3000K | Rf: 88.1 | Rg: 99.7 | CRI: 95+

COLOR VECTOR GRAPHIC

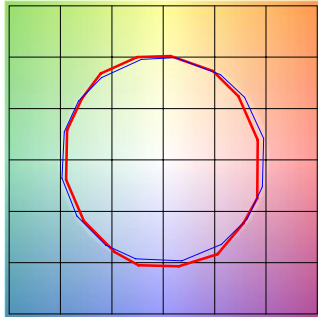

■ Test ■ Reference

HUE BIN	Rf	GRAPHIC SHIFTS %	
		CHROMA	HUE
1	87.7	-5.9%	-0.3%
2	87.9	-4.4%	4.3%
3	82.9	-1.2%	7.9%
4	89.9	0.6%	4.7%
5	92.7	3.0%	3.5%
6	92.7	3.6%	-1.7%
7	90.8	-1.3%	-4.4%
8	93.7	-2.5%	-2.2%
9	91.7	-3.7%	2.3%
10	85.5	-2.8%	7.8%
11	83.3	0.7%	11.0%
12	86.4	5.5%	3.8%
13	90.6	4.6%	-3.6%
14	85.6	5.9%	-8.4%
15	89.5	-0.6%	-5.7%
16	82.6	-2.7%	-12.0%

3500K | Rf: 86.1 | Rg: 95.5 | CRI: 85+

COLOR VECTOR GRAPHIC

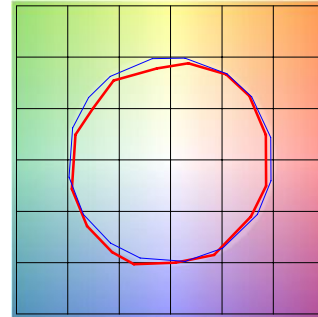

■ Test ■ Reference

HUE BIN	Rf	GRAPHIC SHIFTS %	
		CHROMA	HUE
1	86.6	-4.2%	3.4%
2	91.7	-1.4%	1.8%
3	94.9	-0.7%	0.4%
4	87.9	-4.5%	-4.1%
5	85.9	-10.3%	-2.7%
6	89.8	-5.2%	-0.4%
7	79.6	-9.5%	6.5%
8	87.6	-4.0%	5.7%
9	81.4	-0.5%	11.8%
10	78.3	3.3%	11.4%
11	85.7	6.3%	6.1%
12	86.3	7.1%	-4.6%
13	86.1	-0.7%	-9.6%
14	85.1	0.8%	-10.4%
15	83.4	-4.1%	-5.3%
16	82.5	-3.6%	-5.7%

4000K | Rf: 87.6 | Rg: 96.8 | CRI: 84

COLOR VECTOR GRAPHIC

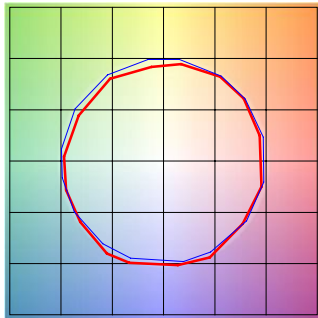

■ Test ■ Reference

HUE BIN	Rf	GRAPHIC SHIFTS %	
		CHROMA	HUE
1	89.0	-3.1%	2.1%
2	93.2	-0.9%	1.3%
3	94.3	-1.1%	0.7%
4	89.5	-4.0%	-2.3%
5	87.6	-7.8%	-1.8%
6	92.2	-4.6%	0.1%
7	87.4	-6.6%	3.6%
8	85.7	-3.8%	7.0%
9	81.5	-1.3%	12.4%
10	80.0	0.9%	11.4%
11	83.3	5.9%	8.7%
12	89.7	4.8%	-0.3%
13	88.5	2.4%	-6.3%
14	92.7	4.0%	-3.8%
15	86.1	-1.6%	-4.5%
16	85.0	-1.4%	-5.0%

5700K | Rf: 80.3 | Rg: 91.5 | CRI: 84

COLOR VECTOR GRAPHIC

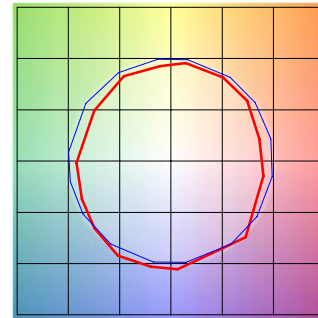

■ Test ■ Reference

HUE BIN	Rf	GRAPHIC SHIFTS %	
		CHROMA	HUE
1	73.8	-11.2%	2.6%
2	83.7	-5.5%	5.8%
3	84.2	-4.0%	5.5%
4	85.8	-3.5%	1.3%
5	85.3	-7.1%	0.6%
6	89.2	-5.8%	-2.2%
7	81.5	-10.7%	1.2%
8	75.7	-9.7%	8.5%
9	74.9	-7.8%	18.8%
10	67.8	-1.6%	18.0%
11	76.1	5.5%	12.0%
12	90.8	4.9%	-1.6%
13	83.6	5.0%	-9.5%
14	81.7	-1.2%	-10.0%
15	69.0	2.0%	-22.8%
16	83.2	-8.5%	-1.0%

PROJECT:

FIXTURE TYPE:

DATE:



LIGHT CHANNEL .6 SURFACE MOUNT DIY (DO-IT-YOURSELF)



REV.05.10.17

TM-30-15 DATA: The data below is for SS2C, SS5C, and SS7C bare LED Soft Strips. Consistent color temperatures throughout a single strip and among multiple strips is possible through a 3 phase binning process in which each order is inspected with a color meter to ensure uniformity.

2700D | Rf: 89.5 | Rg: 100.8 | CRI: 95+

COLOR VECTOR GRAPHIC

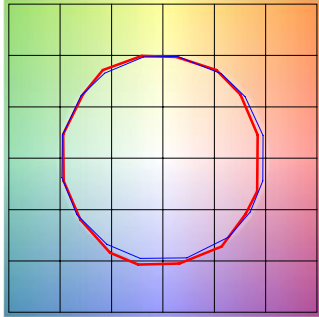

■ Test ■ Reference

HUE BIN	Rf	GRAPHIC SHIFTS %	
		CHROMA	HUE
1	88.8	-5.1%	1.4%
2	89.8	-2.7%	4.1%
3	87.2	0.3%	5.9%
4	92.3	-0.9%	1.0%
5	93.3	1.5%	1.7%
6	92.4	3.6%	-0.2%
7	92.2	-0.9%	-2.4%
8	96.7	-0.4%	-1.1%
9	92.3	-1.2%	3.7%
10	88.9	-0.0%	6.1%
11	86.4	5.1%	7.4%
12	88.2	6.3%	-0.9%
13	87.2	3.8%	-8.1%
14	84.2	3.8%	-11.0%
15	89.8	-2.6%	-4.3%
16	82.7	-3.4%	-11.1%

3000D | Rf: 89.8 | Rg: 101.4 | CRI: 95+

COLOR VECTOR GRAPHIC

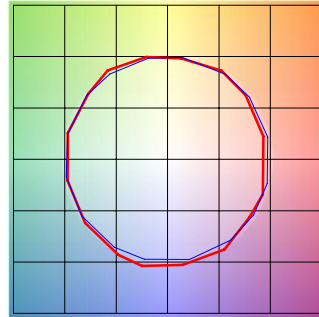

■ Test ■ Reference

HUE BIN	Rf	GRAPHIC SHIFTS %	
		CHROMA	HUE
1	90.2	-4.2%	1.5%
2	90.9	-2.0%	3.7%
3	87.9	0.8%	5.5%
4	92.1	-0.9%	0.6%
5	93.0	1.5%	1.6%
6	92.2	3.9%	-0.2%
7	92.1	-0.3%	-2.0%
8	96.7	0.0%	-1.2%
9	92.5	-0.6%	3.7%
10	88.3	1.1%	7.0%
11	87.2	4.1%	7.4%
12	87.2	6.7%	-1.0%
13	88.2	3.8%	-7.2%
14	85.3	4.3%	-9.9%
15	90.9	-2.2%	-3.6%
16	83.4	-2.2%	-11.2%

TUNABLE WHITE: 2000K - 4000K

2000K only (2K4K) | Rf: 82.8 | Rg: 99.3 | CRI: 86

COLOR VECTOR GRAPHIC

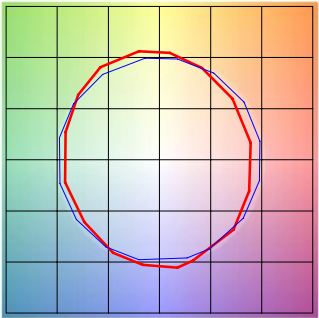

■ Test ■ Reference

HUE BIN	Rf	GRAPHIC SHIFTS %	
		CHROMA	HUE
1	80.1	-9.2%	0.3%
2	77.4	-7.4%	9.0%
3	74.5	-2.3%	12.4%
4	85.3	4.5%	8.6%
5	89.9	7.9%	4.5%
6	88.3	7.2%	-1.8%
7	83.5	1.1%	-10.0%
8	87.1	-4.9%	-6.7%
9	88.3	-5.3%	-0.0%
10	84.6	-5.1%	6.4%
11	84.3	1.0%	9.1%
12	84.2	4.1%	4.7%
13	85.8	7.4%	-11.4%
14	60.8	0.6%	-19.6%
15	77.8	-1.6%	-14.7%
16	78.1	-7.8%	-11.5%

4000K only (2K4K) | Rf: 89.6 | Rg: 99.1 | CRI: 87

COLOR VECTOR GRAPHIC

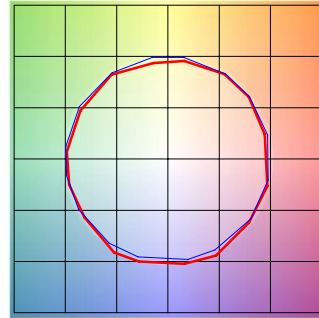

■ Test ■ Reference

HUE BIN	Rf	GRAPHIC SHIFTS %	
		CHROMA	HUE
1	91.3	-2.5%	1.0%
2	95.3	-0.5%	0.5%
3	94.3	-0.7%	1.1%
4	91.1	-3.4%	-1.1%
5	89.5	-5.6%	0.0%
6	94.6	-1.4%	1.3%
7	93.2	-3.0%	2.6%
8	91.3	-1.8%	4.6%
9	86.5	-0.9%	9.1%
10	83.3	-0.5%	9.5%
11	83.3	4.9%	9.0%
12	89.7	4.1%	1.7%
13	90.1	3.6%	-4.3%
14	93.4	5.2%	-2.1%
15	87.4	0.4%	-4.3%
16	86.6	0.4%	-6.1%

2K4K (3000K) | Rf: 90.2 | Rg: 101.4 | CRI: 90+

COLOR VECTOR GRAPHIC

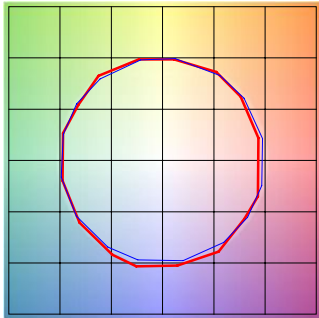

■ Test ■ Reference

HUE BIN	Rf	GRAPHIC SHIFTS %	
		CHROMA	HUE
1	90.9	-3.8%	1.3%
2	91.7	-1.9%	3.3%
3	88.7	0.7%	5.1%
4	92.4	-1.0%	0.7%
5	92.9	0.9%	1.7%
6	93.1	3.3%	-0.6%
7	91.0	-1.8%	-0.4%
8	97.0	0.2%	-1.1%
9	92.8	-0.5%	3.6%
10	88.3	1.0%	7.0%
11	87.1	3.8%	7.8%
12	87.6	6.5%	-0.3%
13	89.3	3.6%	-6.3%
14	86.1	4.5%	-9.1%
15	91.6	-1.9%	-3.1%
16	83.8	-1.5%	-11.2%