

MINIPOINT LED - INDOOR/OUTDOOR

REV.05.19.15



MPORT-12VAC-ST-SS



MPORT-12VAC-EL-SS



LFMP-20D
20° Beam Tilt Lens
(included with Eyelid)



MPORT-12VAC-ST-SS with
Junction Cover MPORT-JC

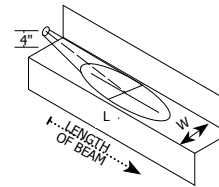
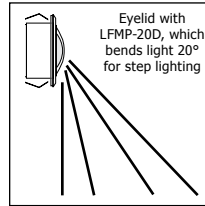

Wall Mounting

LENGTH	FC	WIDTH
3"	36.2	6"
6"	70.6	6.5"
9"	88.5	9"
12"	47.8	9.5"

EYE LID comes with 20°
Tilt Film #LFMP-20D

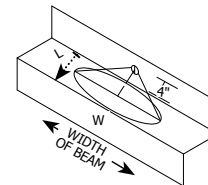
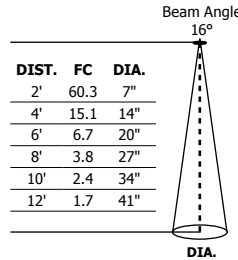

Step Mounting

LENGTH	FC	WIDTH
3"	41	9.5"
6"	53.2	9.5"
9"	36	10"
12"	20	9"

EYE LID comes with 20°
Tilt Film #LFMP-20D &
Linear Spread Film#LFMP-
LS (order separately)

Description:

Miniport LED is slim and can be recessed into a wall or floor using a Miniport junction box (sold separately, see page 2), which mounts to an octagon box or outdoor, wet-location electrical box. The fixture, with a 2.3 watt warm-white LED, features a 16 degree precise focus and tempered glass lens with a stainless steel, round beveled edge trim.

Miniport is compatible with the TE-60L-12 power supply. The Miniport Eyelid version, which should be wall-mounted 4" from floor, includes LFMP-20D, a lens film to tilt the light beam 20 degrees. All Miniport versions include 5 year warranty.

Finish:

Stainless Steel

Lamp Specification:

2.3 Total Watts with driver, 12VAC LED, 3000K, 82CRI, 47 lumens, 70% lumen maintenance based on 50,000 hours of operation

Dimming Information:

Dims with electronic low-voltage dimmer

Power Supply:

60 watt, 120 volt input, 12 volt AC output **TE-60L-12**

Weight:

1 lb (.45 kg)

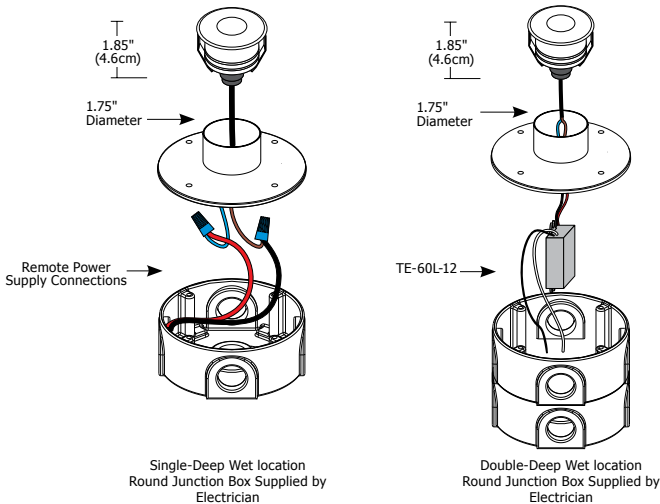
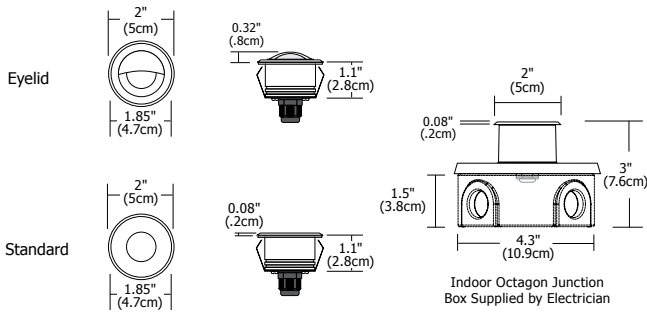

Product Voltage Trim Finish

MPORT - **12VAC** - **ST** - **SS**

MPORT Miniport Head 12VAC 12 Volt AC ST Surface Trim EL Eyelid SS Stainless Steel

MINIPOINT LED COMPONENTS & ACCESSORIES

REV.05.13.15

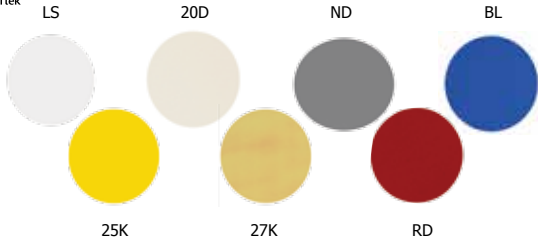

Film Lenses and Filters

Add film lenses and filters to shape beam, change color or adjust color temperatures.

Lens Film	Lens or Color
LFMP	20D
LFMP Lens Film Miniport	20D Refracts beam 20° down
	25K 2500K Very Warm White
	27K 2700K Very Warm White
	ND Neutral Density Filter dims light 50%
	RD Red Film
	BL Blue Film
	LS Linear Spread



Junction Cover

Use indoor with standard octagon electrical box or use outdoor with wet location electrical box.

Product	Description
MPORT	JC
MPORT Miniport	JC Junction Cover

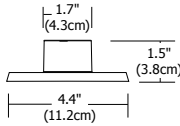

Power Supply/Driver

Power Supply (60W/12VAC) converts standard 120 volt line voltage to 12 volts and features built-in short-circuit protection. Fits inside an electrical junction box.

Product	Type	Voltage
TE	60L	12
TE Transformer Electronic	60L 60 Watt LED and halogen	12 12 Volt, AC

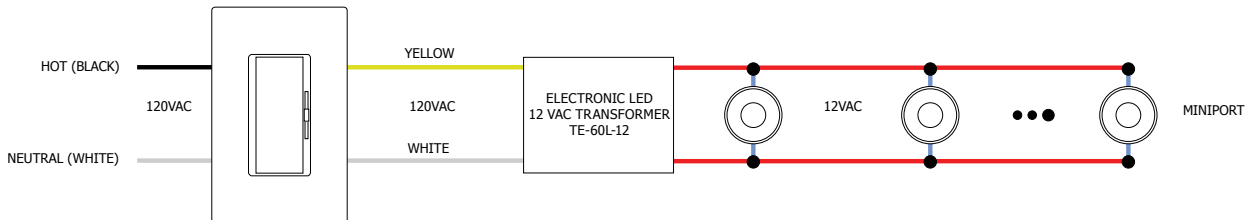

PROJECT:

FIXTURE
TYPE:

DATE:

