

CIRRUS SUSPENSION WALL WASH

WITH REMOTE POWER, END FEED

DESIGNED BY GREGORY KAY | ASSEMBLED IN AMERICA

REV 05.11.20

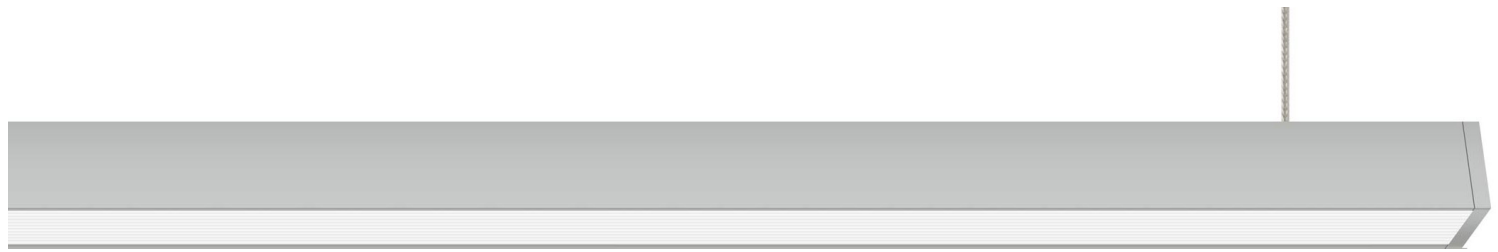

DESCRIPTION

Cirrus Suspension Wall Wash with Remote 24VDC power supply (sold separately) is a linear LED fixture that offers a wall wash lens for a smooth and uniform beam spread. This fixture is available in various increments from 12" to 288". It includes a choice of 2.8" or 4.6" square or round canopy, 12ft adjustable coaxial 24VDC power cord, and 12ft aircraft cable every 4ft. Feed power at either left or right end (when viewing wall to be washed), or you may adjust to center within 5ft of either end. May use with a 50 watt Class 2 power supply mounted inside ceiling junction box or a 100 watt remote power supply up to 40ft away. Fixture includes a 5 year pro-rated warranty. For custom designs and quotes, send drawings to design@PureEdgeLighting.com.

Wattages for this fixture are available in the following options:

- 7W - 7.3 watts per foot, lengths up to 160" (13.3')
- 10W - 9.6 watts per foot, lengths up to 120" (10')

INSTALLATION

- Mounts to a standard junction box, prewired from either a 120V with a 60 watt NON-IC (50W-IC) power supply that fits in the ceiling electrical junction box, or from a remote power supply feeding 24VDC up to 200 watts at a maximum of 40ft away
- Includes Canopy of your choice: 2.8" or 4.6", available in Round or Square, Pairs - One for remote power and one for a blank end cap, and VR (Vanishing Point)
- Includes adjustable 12ft coaxial and aircraft cables (additional aircraft cables included for support when fixture exceeds 72")
- Power supplies sold separately

FINISHES

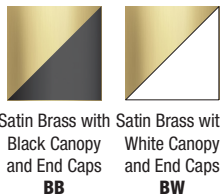
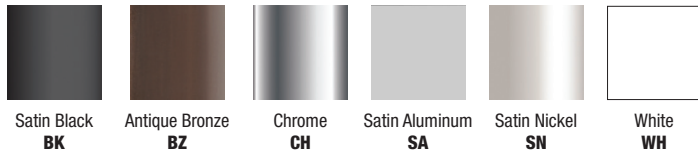

Satin Brass with Black Canopy and End Caps **BB**
Satin Brass with White Canopy and End Caps **BW**

LENSES

Diffused asymmetric Wall Wash lens for a smooth and uniform beam spread

APPLICATIONS

Designed for indoor or damp location. Ideal environments include: Kitchens, dining rooms, hallways, conference rooms, offices, architectural and retail.

LAMPING

- Choose from 7 color temperatures
- 50,000 Hour Lamp Life

REMOTE POWER SUPPLIES*, DIMMERS & CONTROLS (SOLD SEPARATELY)

- Electronic Low Voltage Dimming (**ELV**): 100 Watt, Class 2
- Title 24 with Uni Driver
- Uni Driver dims with ELV, Triac, or 0-10
- 0-10 Volt Dimming (**0-10V**)
- Lutron Hi-Lume®

* In-Wall Mounting Kits available for select power supplies. Dimmers not available through PureEdge Lighting

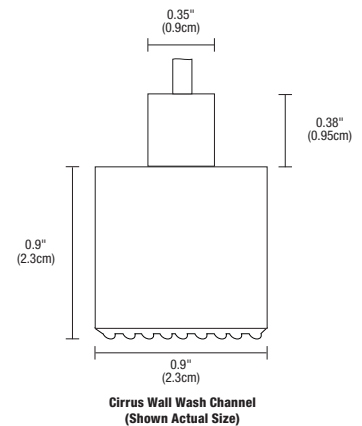
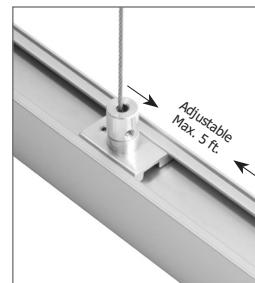

System	Wattage Per Foot	Canopy	Nominal Size	Color Temperature	Finish
CSWL	7W	2R	160	22K	SN
CSWL Cirrus Suspension Wall Wash Left Power Feed CSWR Cirrus Suspension Wall Wash Right Power Feed	7W 7.5 Watt (160" max, 24') 10W 10 Watt (160" max, 18')	2R 2.8" Round Canopy 2S 2.8" Square Canopy 4R 4.6" Round Canopy 4S 4.6" Square Canopy VR Vanishing Point Plaster in system with No Canopy 2R2 2x2.8" Round Canopies 2S2 2x2.8" Square Canopies 4R2 2x4.6" Round Canopies 4S2 2x4.6" Square Canopies	12-160 Order in various increments from 12" to 160". Maximum shipping length is 120"; Maximum shipping length for Chrome is 84". *See length chart for exact dimensions (pg. 2)	22K 2200K Amber White 24K 2400K Very Warm White 27K 2700K Incandescent White 30K 3000K Warm White 35K 3500K Neutral White 40K 4000K Cool White 57K 5700K Daylight White	BK Satin Black BZ Antique Bronze CH Chrome SA Satin Aluminum SN Satin Nickel WH White BB Satin Brass with Black Canopy and End Caps BW Satin Brass with White Canopy and End Caps

PROJECT	FIXTURE TYPE	DATE
---------	--------------	------

Length Chart: Actual lengths for Cirrus Suspension Wall Wash with Remote Power, End Feed

22K, 24K, 27K, 30K, 35K, 40K, & 57K							
Nominal Length (Inches)	Actual Length (Inches)	Total Wattage (5W)	Total Wattage (7W)	Nominal Length (Inches)	Actual Length (Inches)	Total Wattage (5W)	Total Wattage (7W)
12	13	8	10	87	87.4	54	72
15	15.4	9	12	89	89.8	56	74
17	17.8	11	14	92	92.2	58	77
20	20.2	13	17	94	94.6	59	78
22	22.6	14	18	96	97.0	60	80
24	25	15	20	99	99.4	62	82
27	27.4	17	22	101	101.8	63	84
29	29.8	18	24	104	104.2	65	87
32	32.2	20	27	106	106.6	66	88
34	34.6	21	28	108	109.0	68	90
36	37.0	23	30	111	111.4	69	92
39	39.4	24	32	113	113.8	71	94
41	41.8	26	34	116	116.2	73	97
44	44.2	28	37	118	118.6	74	98
46	46.6	29	38	120	121.0	75	100
48	49.0	30	40	123	123.4	77	
51	51.4	32	42	125	125.8	78	
53	53.8	33	44	128	128.2	80	
56	56.2	35	47	130	130.6	81	
58	58.6	36	48	132	133.0	83	
60	61.0	38	50	135	135.4	84	
63	63.4	39	52	137	137.8	86	
65	65.8	41	54	140	140.2	87	
68	68.2	43	57	142	142.6	89	
70	70.6	44	58	144	145.0	90	
72	73.0	45	60	147	147.4	92	
75	75.4	47	62	149	149.8	93	
77	77.8	48	64	152	152.2	95	
80	80.2	50	67	154	154.6	96	
82	82.6	51	68	156	157.0	98	
84	85.0	53	70	159	159.4	99	

DESCRIPTION	CCWL, CCWR													
	CIRRUS WALL WASH LENS													
WATTS PER FOOT	7W (7.3 watts)							10W (9.6 watts)						
COLOR TEMPERATURE	22K	24K	27K	30K	35K	40K	57K	22K	24K	27K	30K	35K	40K	57K
LUMENS PER FOOT (lm/ft)	272	308	332	362	415	451	480	321	265	392	490	567	380	405
LUMENS PER WATT (lm/w)	37	42	45	50	57	62	66	33	38	41	51	59	86	92
CRI	85+	90+	95+	95+	85+	84	84	85+	90+	95+	85+	84	84	84

FIXTURE MOUNTED 24" FROM WALL

2'	25	25	25	25	25	25
3'	28	28	28	28	28	28
4'	22	22	22	22	22	22
5'	15	15	15	15	15	15
6'	11	11	11	11	11	11
7'	9	9	9	9	9	9
8'	5	5	5	5	5	5

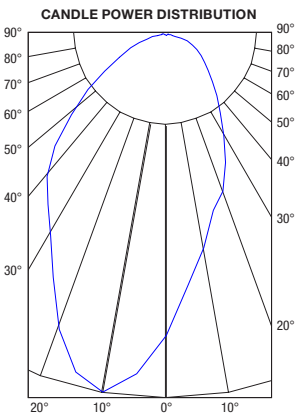

7 Watt 100°	
Distance	Foot Candles
1'	200
1.5'	131
2'	96
3'	62
4'	45
5'	33
6'	26
7'	21
8'	18

10 Watt 100°	
Distance	Foot Candles
1'	227
1.5'	148
2'	110
3'	71
4'	51
5'	38
6'	30
7'	23
8'	18

Lamp Data: 50,000 Hour lamp Life

Version	Watts per Foot	Lumens per Watt per Foot	85+CRI	95+CRI
			22K, 35K, 40K, 57K	27K, 30K
7W	7.3	37 340	●	●
10W	9.6	43 387	●	●

Lumen values are based on the 3000K LED test.

PROJECT	FIXTURE TYPE	DATE
---------	--------------	------

DRAWINGS Drawings are shown with 2" Round Canopy, 2" Square Canopy, 4" Round Canopy, and 4" Square Canopy

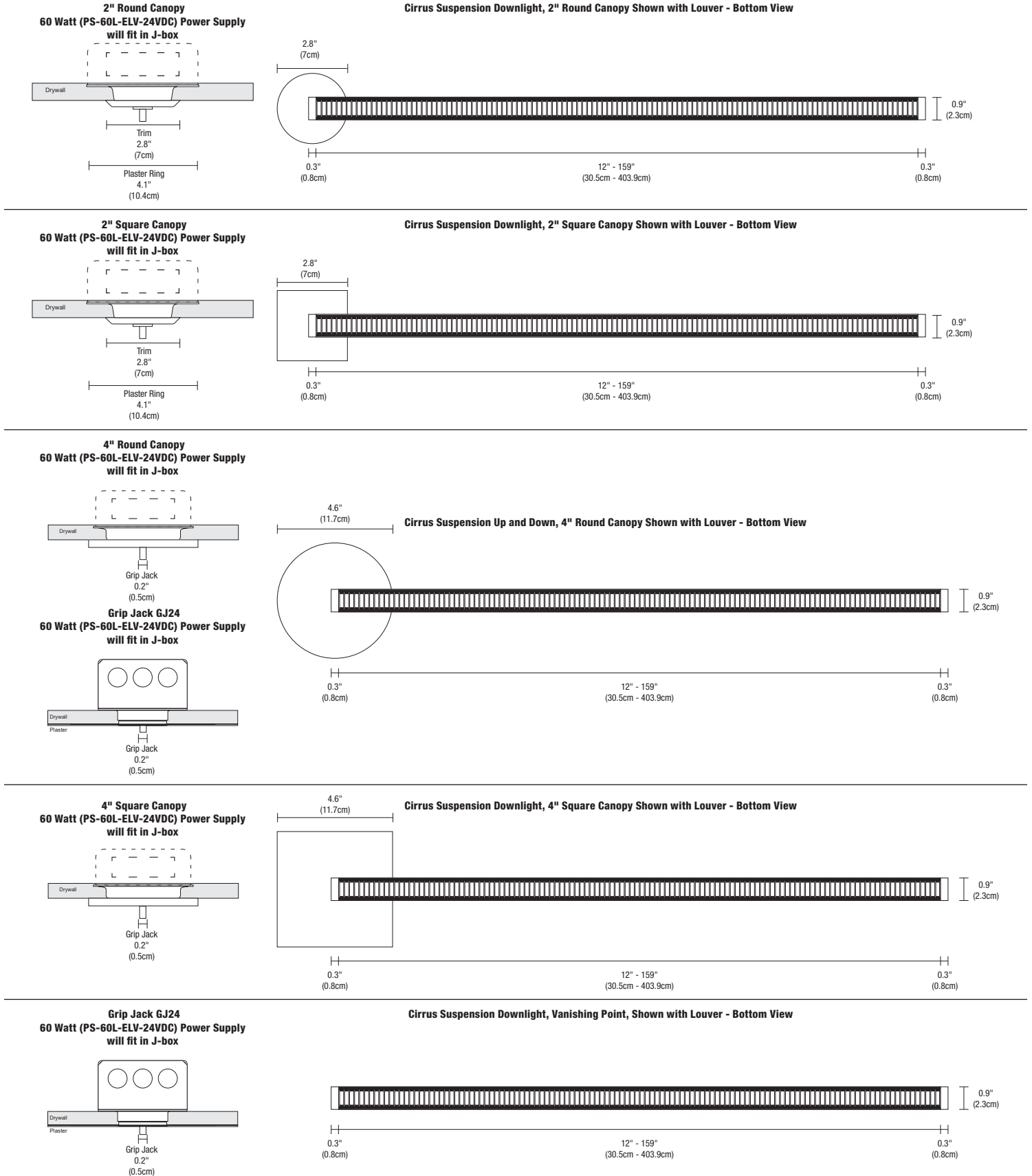

PROJECT		FIXTURE TYPE		DATE	
---------	--	--------------	--	------	--

COMPONENTS Swag Bar & Hook, Swag Hook, and T-Bar are compatible with all Power Canopy options and may be required based on lighting design and application

NEW CONSTRUCTION & REMODEL 2" COVER FOR 4" SQUARE JUNCTION BOX

The New Construction NC2-JBOX Cover is included with the 2" Round and Square Canopies and is not required for the 4" Square Canopies. NC2 New Construction Junction Box Cover mounts to a standard 4" Electrical Box or Octagon Box, converting it to a 2" Plaster Ring for use with the 2R (Round) or 2S (Square) Canopy. The Remodel RM2-JBOX Plaster Plate cover is used with an existing 4" Square Junction Box and standard Round Plaster Ring. The PS-60L-ELV-24VDC (50 Watt IC, 60 Watt Non-IC) will fit inside the NC2 or RM2-JBOX Cover and Electrical Junction Box for a flush look.

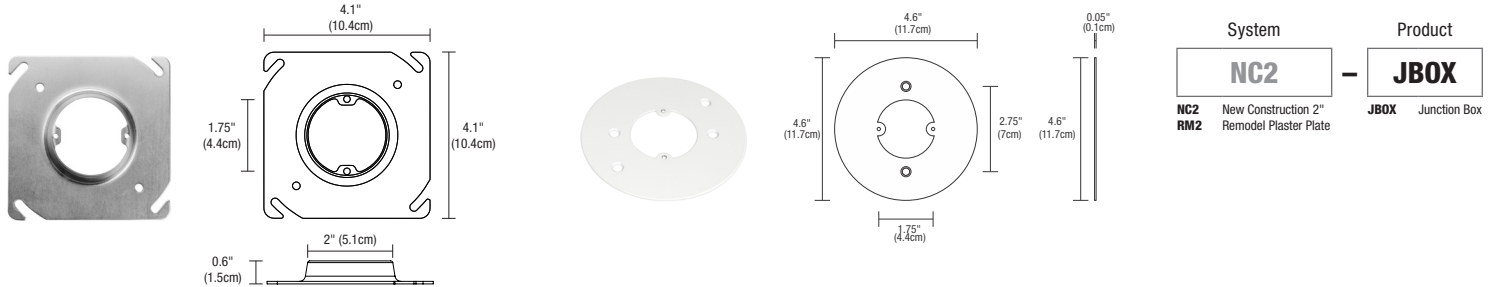

CIRRUS REMOTE POWER CANOPIES (INCLUDED)

Canopies are included with Canopy ordering code. The 2" Round and Square Canopy includes a special Plaster Ring NC2-JBOX (above). The 4" Square or Round Canopy fits on a standard 4" Electrical Box with Round Plaster Ring and the PS-60L-ELV-24VDC 50 Watt IC, 60 Watt Non-IC) will fit inside the NC2 or RM2-JBOX Cover and Electrical Junction Box for a flush look. Vanishing Point Plaster in system with No Canopy, only see cable going through drywall ceiling with GJ24.

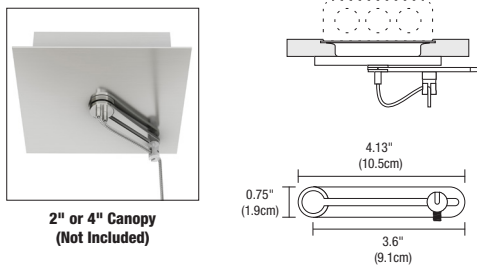
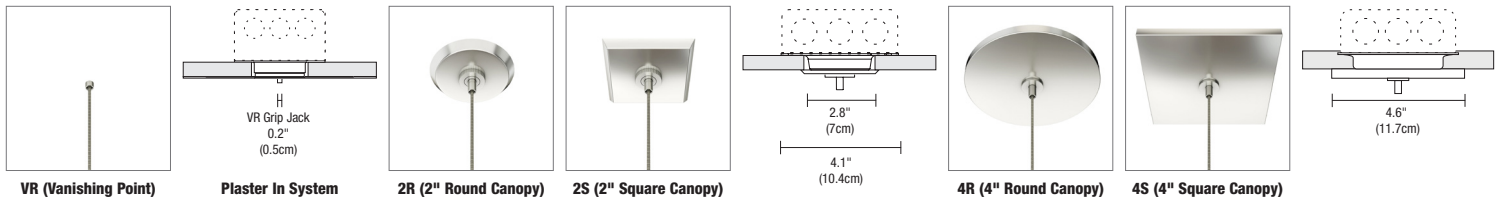

CHANNEL SUSPENSION ADJUSTABLE SWAG BAR & HOOK

Channel Suspension Adjustable Swag Bar and Hook allows a cable to form a straight connection to the Channel when the Power Canopy is not located directly above the fixture. Use when you have two or more Canopies (Power Supplies) on the same fixture run. The Adjustable Swag Hook is compatible with the 2R, 2S, 4R, 4S, 5S, 6S, and 8R Power Canopies (Canopy not included).

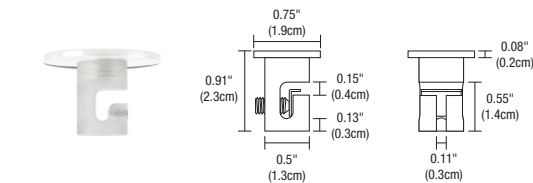
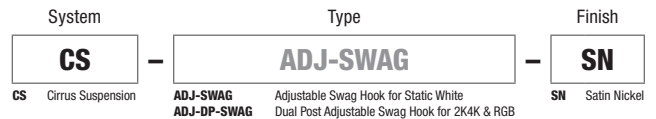

CHANNEL SUSPENSION SWAG HOOK

The clear plastic Swag Hook extends a cable from an electrical box that is not located directly above desired fixture location.

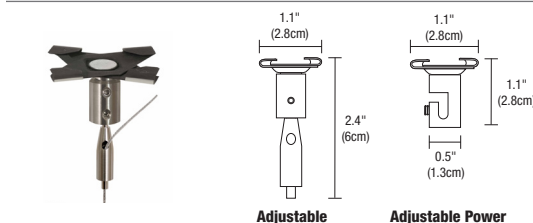
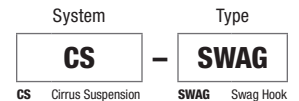

CIRRUS SUSPENSION ADJUSTABLE T-BAR CLIP

Cirrus Suspension Adjustable T-Bar Clip mounts to T-Bar grid ceilings. Available in Satin Nickel Hardware as Adjustable Power and Non-Power versions.

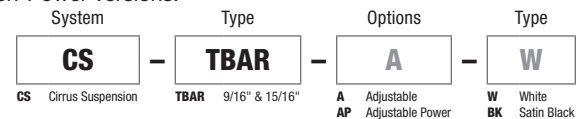

PROJECT	FIXTURE TYPE	DATE
---------	--------------	------

DRAWINGS Side-View shown with two 2" and 4" Canopies; one for Remote Power, one Blank

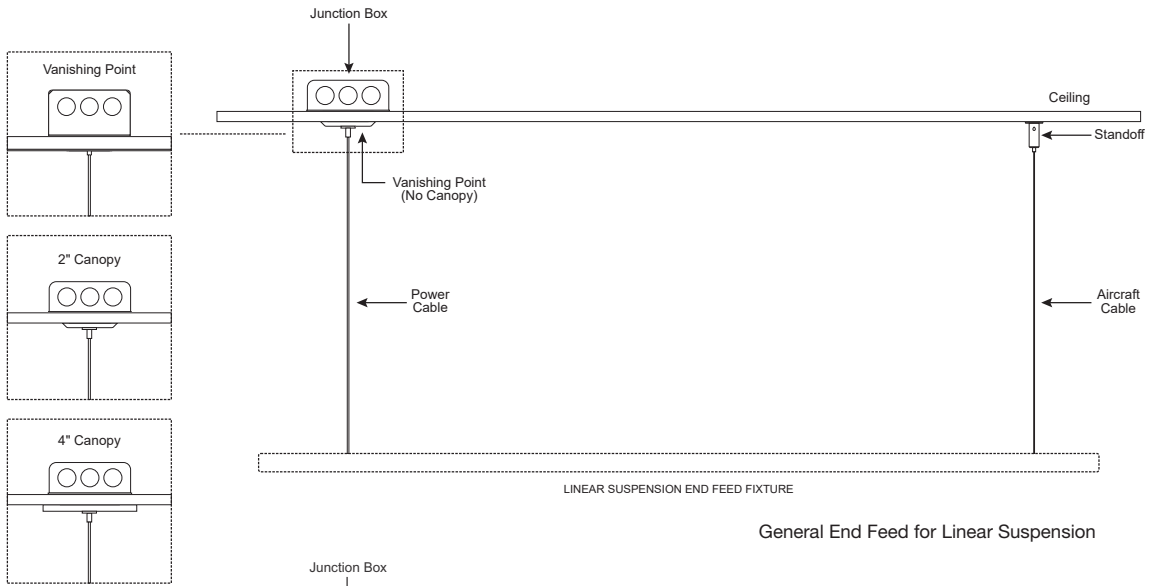

General End Feed for Linear Suspension

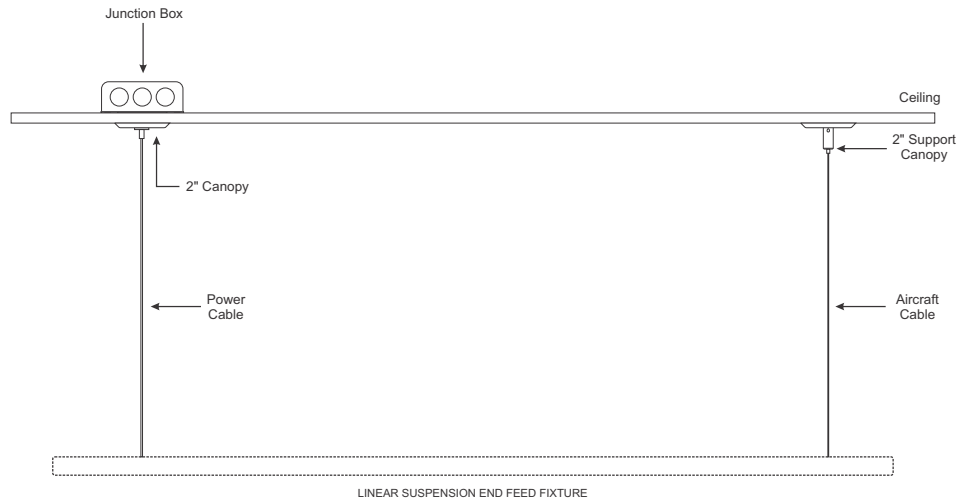

General 2S2 & 2R2 for Linear Suspension

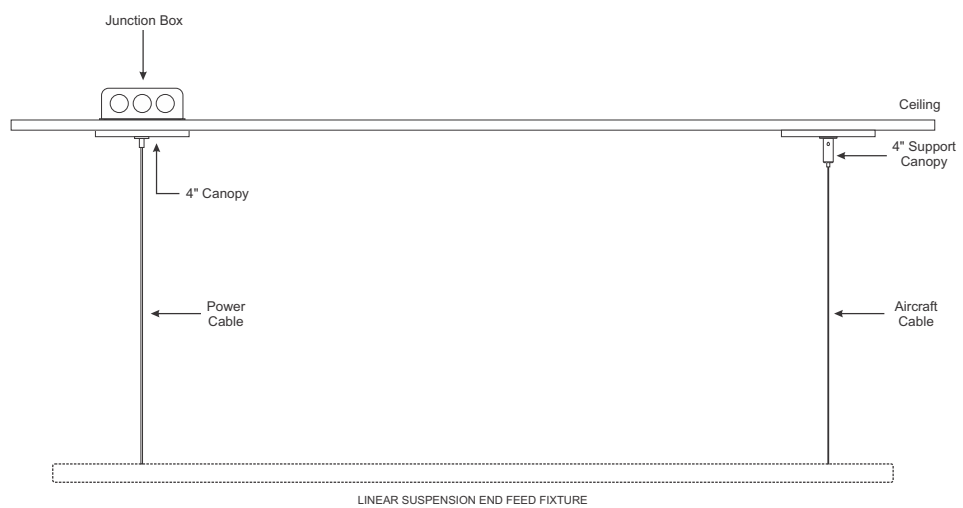

General 4S2 & 4R2 for Linear Suspension

PROJECT	FIXTURE TYPE	DATE
---------	--------------	------

WIRING DIAGRAM Wiring Diagram for Static White with ELV Dimmer

APPLICATION ELV dimming for Cirrus Power Suspension, End Feed Canopy, Static White

REMOTE POWER SUPPLIES Class 2: 24VDC output; 120VAC input | PS-60L-ELV-24VDC (fits in J-box) | PSB-60W-ELV-24VDC
PSB-100W-ELV-24VDC

DIMMING Dimmable with ELV dimmer: Legrand, Adorne ADTP703TU
Lutron: Diva DVELV-300P, Skylark SELVz-300P, Maestro MAELV-600 and Radio Ra 2

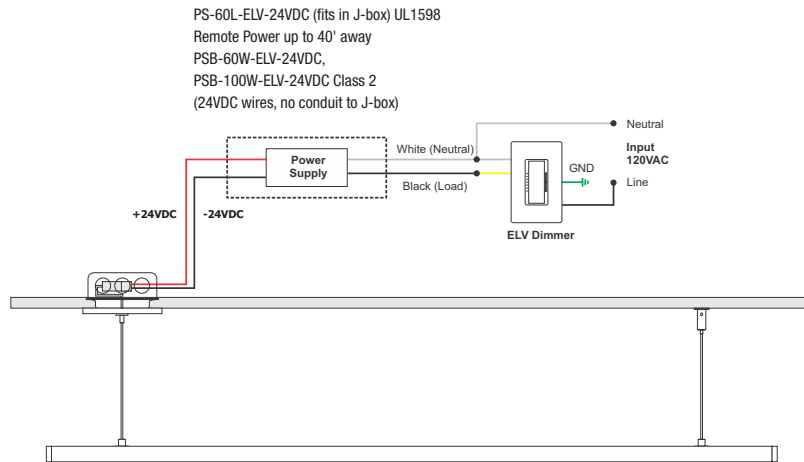

WIRING DIAGRAM Wiring Diagram for Static White with 0-10V Dimmer





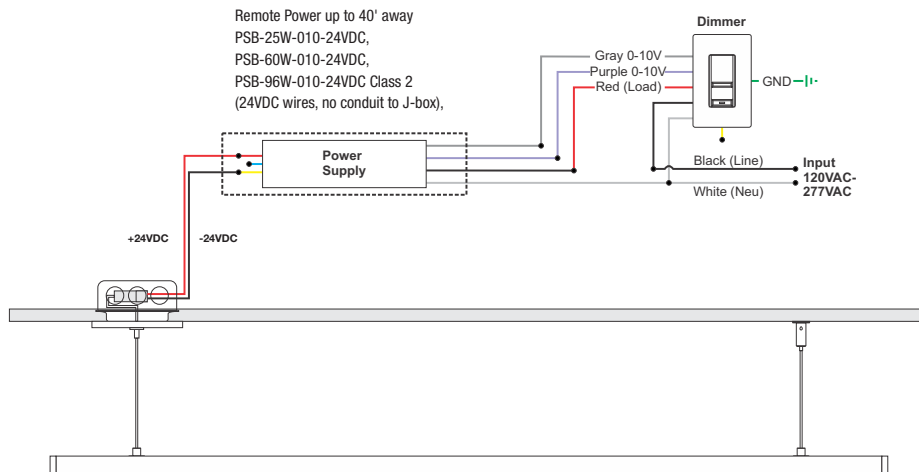

APPLICATION 0-10V dimming for Cirrus Suspension Downlight, End Feed Canopy, Static White

REMOTE POWER SUPPLIES Class 2: 24VDC output; 120/277VAC input | PSB-60W-010-24VDC | PSB-100W-010-24VDC

DIMMING Dimmable with 0-10V dimmer: Philips: Sunrise SR1200ZTUNV; Lutron: Diva DVTV-WH, Nova-T NTSTV-DV-XX, Grafix Eye QS QSGRJ-XP, Radio RA2 RRD-1-ND; Leviton: LEV40050, IP710-LFZ; Legrand ADPD4FBL3P2W4



PROJECT	FIXTURE TYPE	DATE
---------	--------------	------

ELECTRONIC LOW-VOLTAGE (ELV) POWER SUPPLIES & RECOMMENDED DIMMERS†‡				
ORDERING CODES	PSB-60L-ELV-24VDC 	PSB-60W-ELV-24VDC 	PSB-2X60W-ELV-24VDC 	PSB-100W-ELV-24VDC 
SPECIFICATIONS				
MAXIMUM LOAD	60W NON-IC, 50W-IC (FITS IN JBOX)	60W	2X60W	96W
INPUT VOLTAGE	120VAC	120VAC	120VAC	120VAC
OUTPUT VOLTAGE	24VDC	24VDC	24VDC	24VDC
DIMENSIONS	2.25" X 1.25" X 0.83"	8.125" X 2" X 1.75"	12.15" X 6.48" X 2.18"	9.25" X 3.5" X 2"
CLASSIFICATION	CLASS 2	CLASS 2	CLASS 2	CLASS 2
IN WALL MOUNTING	N/A	PSB-60W-ELV-24VDC-IW	PSB-2X60W-ELV-24VDC-IW	PSB-100W-ELV-24VDC-IW
ELECTRONIC LOW-VOLTAGE (ELV) POWER SUPPLIES & RECOMMENDED DIMMERS†‡				
ORDERING CODES	PSB-2X100W-ELV-24VDC 	PSB-3X100W-ELV-24VDC 	PSB-4X100W-ELV-24VDC 	
SPECIFICATIONS				
MAXIMUM LOAD	2X96W	3X96W	4X96W	
INPUT VOLTAGE	120VAC	120VAC	120VAC	
OUTPUT VOLTAGE	24VDC	24VDC	24VDC	
DIMENSIONS	12.15" X 6.48" X 2.18"	14" X 10" X 3"	17" X 13" X 3"	
CLASSIFICATION	CLASS 2	CLASS 2	CLASS 2	
IN WALL MOUNTING	PSB-2X100W-ELV-24VDC-IW	N/A	N/A	
DIMMING AND CONTROLS				
LUTRON DIVA: DVELV-300P	•	•	•	
LUTRON SKYLARK: SELV-300P	•	•	•	
LUTRON RADIO RA2: RRD-6NA	•	•	•	
LUTRON MAESTRO: MAELV-600	•	•	•	
LEGRAND ADORNE: ADTP-703TUM4	•	•	•	

†22K - 57K color temperatures are compatible with 0-10V, ELV, and Lutron Hi-lume® Power Supplies. Warm Dim (27D, 30D) color temperatures are only compatible with ELV power supplies. Tunable White (2K4K) color temperature is compatible with 0-10V, ELV, DMX, and Lutron Hi-lume® Power Supplies. Dynamic Color (RGB, RGB+W) and Static Color (Amber, Blue, Green, or Red) are compatible with DMX Power Supplies.

‡Electrical Panels using Seimens/Murray AFCI breakers are not compatible with this ELV transformer. Use 0-10 Volt power supplies with this breaker

With N-Lite Dimming Do not use ELV power supplies, use only 0-10 volt or Uni drivers power supplies

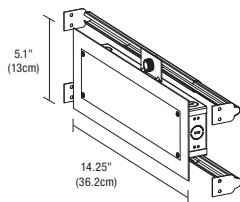

5.1 x 14.25 inch In-Wall Mounting Kit: Includes power supply, box cover and stud hangers for installing Junction Box in wall. Select "IW" in the options section of compatible power supply ordering codes if an In-Wall Mounting Kit is needed.

Ordering Codes: PSB-60W-ELV-24VDC-IW
PSB-100W-ELV-24VDC-IW

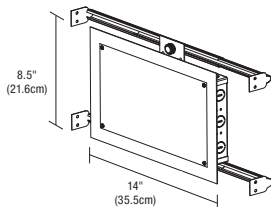

8.5 x 14 inch In-Wall Mounting Kit: Includes power supply, box cover and stud hangers for installing Junction Box in wall. Select "IW" in the options section of compatible power supply ordering codes if an In-Wall Mounting Kit is needed.

Ordering Codes: PSB-2X60W-ELV-24VDC-IW
PSB-2X100W-ELV-24VDC-IW

PROJECT		FIXTURE TYPE		DATE	
---------	--	--------------	--	------	--

SAMPLE WIRING DIAGRAMS 24VDC ELV

Application: ELV dimming for Static White

Dimming: Dimmable with ELV dimmer: Legrand, Adorne ADTP703TU; Lutron: Diva DVELV-300P, Skylark SELV-300P, Maestro MAELV-600 and Radio Ra 2

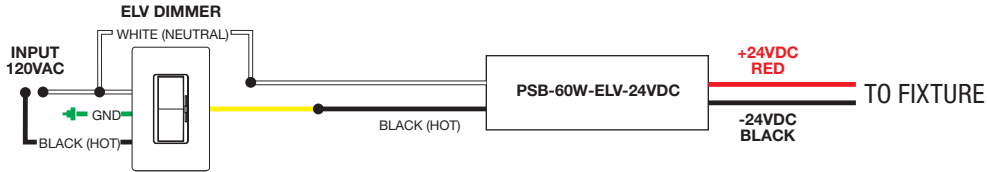

Application: ELV dimming for Static White

Dimming: Dimmable with ELV dimmer: Legrand, Adorne ADTP703TU; Lutron: Diva DVELV-300P, Skylark SELV-300P, Maestro MAELV-600 and Radio Ra 2

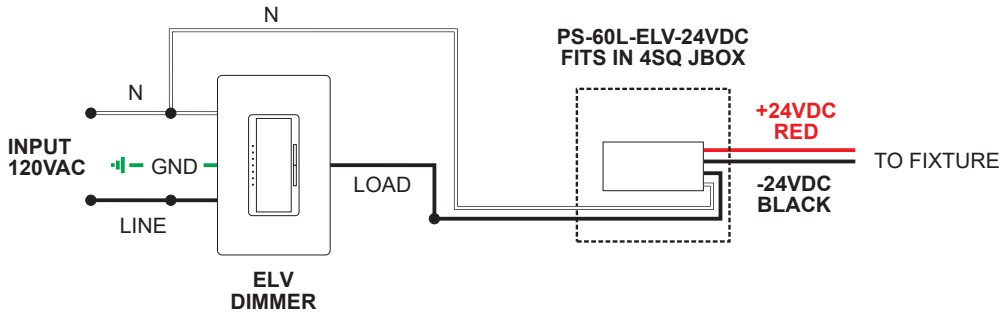

PROJECT		FIXTURE TYPE		DATE	
---------	--	--------------	--	------	--

0-10 VOLT (010) POWER SUPPLIES & RECOMMENDED DIMMERS†				
ORDERING CODE	PSB-25W-010-24VDC 	PSB-60W-010-24VDC 	PSB-96W-010-24VDC 	PSB-2X96W-010-24VDC
SPECIFICATIONS				
MAXIMUM LOAD	25W	60W	96W	2X96W
INPUT VOLTAGE	120VAC	120-277VAC	120-277VAC	120-277VAC
OUTPUT VOLTAGE	24VDC	24VDC	24VDC	24VDC
DIMENSIONS	12.4" X 3.12" X 2.18"	12.4" X 3.12" X 2.18"	12.4" X 3.12" X 2.18"	12.15" X 6.48" X 2.18"
CLASSIFICATION	CLASS 2	CLASS 2	CLASS 2	CLASS 2
IN-WALL MOUNTING	PSB-25W-010-24VDC-IW	PSB-60W-010-24VDC-IW	PSB-96W-010-24VDC-IW	PSB-2X96W-010-24VDC-IW

0-10 VOLT (010) POWER SUPPLIES & RECOMMENDED DIMMERS†			
ORDERING CODE	PSB-3X96W-010-24VDC 	PSB-4X96W-010-24VDC 	
SPECIFICATIONS			
MAXIMUM LOAD	3X96W	4X96W	
INPUT VOLTAGE	120-277VAC	120-277VAC	
OUTPUT VOLTAGE	24VDC	24VDC	
DIMENSIONS	14" X 10" X 3"	17" X 13" X 3"	
CLASSIFICATION	CLASS 2	CLASS 2	
IN-WALL MOUNTING	N/A	N/A	
DIMMING & CONTROLS			
PHILIPS SUNRISE: SR1200ZTUNV	•	•	
LUTRON DIVA: DVTV-WH, DVSTV-WH	•	•	
LUTRON NOVA T: NTSTV-DV-XX	•	•	
LUTRON GRAFIX EYE QS: QSGRJ-XP	•	•	
LUTRON RADIO RA2: RRD-10ND	•	•	
LEVITON: LEV40050	•	•	
LEVITON IP710-LFZ	•	•	
LEGRAND: ADPD4FBL3P2W4	•	•	

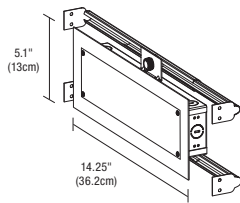

5.1 x 14.25 inch In-Wall Mounting Kit: Includes power supply, box cover and stud hangers for installing Junction Box in wall. Select "IW" in the options section of compatible power supply ordering codes if an In-Wall Mounting Kit is needed.

Ordering Codes: PSB-25W-010-24VDC-IW, PSB-60W-010-24VDC-IW, PSB-96W-010-24VDC-IW

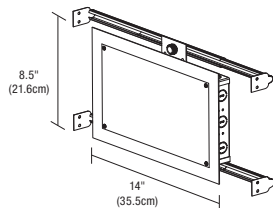

8.5 x 14 inch In-Wall Mounting Kit: Includes power supply, box cover and stud hangers for installing Junction Box in wall. Select "IW" in the options section of compatible power supply ordering codes if an In-Wall Mounting Kit is needed.

Ordering Codes: PSB-2X96W-010-24VDC-IW

PROJECT		FIXTURE TYPE		DATE	
---------	--	--------------	--	------	--

SAMPLE WIRING DIAGRAMS 24VDC 010

Application: 0-10V Dimming Applications For Static White and Warm Dim 0-10V Dual Dimming.

Dimming: Dimmable with 0-10V dimmers: Signify (Phillips) Sunrise: SR1200ZTUNV, Leviton Dimmers: LEV40050, IP710-LFZ, *IP710-DLZ *(Built in LED locator light) Legrand Dimmer: ADPD4FBL3P2W4 Lutron Systems: Lutron GRAFIX Eye QS Main Unit (with DRX-TVI) Radio Ra2 (with GRX-TVI)

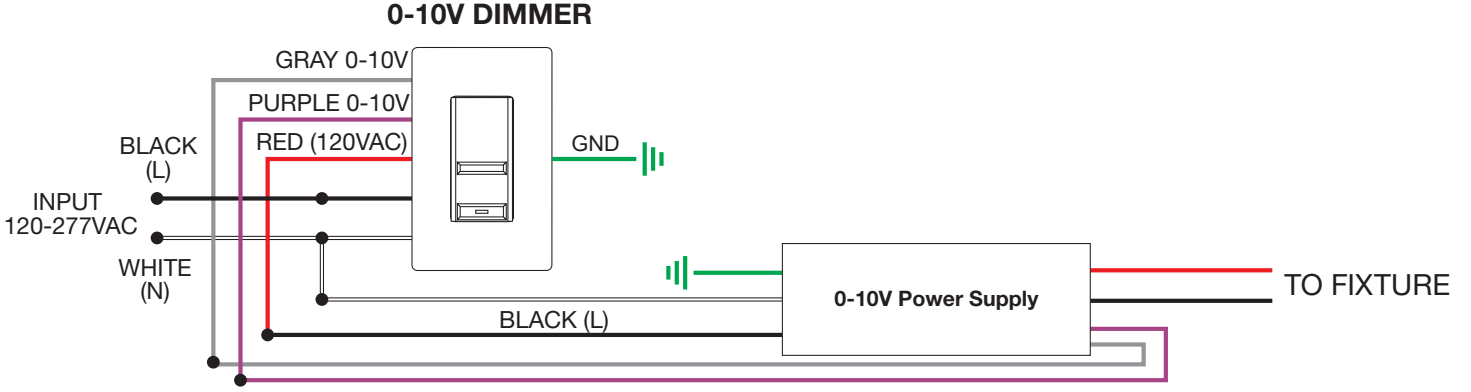

PROJECT		FIXTURE TYPE		DATE	
---------	--	--------------	--	------	--

INDOOR CONSTANT VOLTAGE REMOTE POWER SUPPLIES

24VDC, UNI - UNIVERSAL DIMMING WITH ELV, TRIAC, & 0-10V

REV 05.11.20

UNIVERSAL POWER SUPPLIES & RECOMMENDED DIMMERS				
ORDERING CODE	PSB-40W-UNI-24VDC 	PSB-60W-UNI-24VDC 	PSB-2X40W-UNI-24VDC 	PSB-2X60W-UNI-24VDC
SPECIFICATIONS				
MAXIMUM LOAD	40W	60W	2X40W	2X60W
INPUT VOLTAGE	120-277VAC	120-277VAC	120-277VAC	120-277VAC
OUTPUT VOLTAGE	24VDC	24VDC	24VDC	24VDC
DIMENSIONS	12.4" X 3.12" X 2.18"	12.4" X 3.12" X 2.18"	12.15" X 6.48" X 2.18"	12.15" X 6.48" X 2.18"
CLASSIFICATION	CLASS 2	CLASS 2	CLASS 2	CLASS 2
IN-WALL MOUNTING	PSB-40W-UNI-24VDC-IW	PSB-60W-UNI-24VDC-IW	PSB-2X40W-UNI-24VDC-IW	PSB-2X60W-UNI-24VDC-IW
UNIVERSAL POWER SUPPLIES & RECOMMENDED DIMMERS				
ORDERING CODE	PSB-96W-UNI-24VDC 	PSB-2X96W-UNI-24VDC 	PSB-3X96W-UNI-24VDC 	PSB-4X96W-UNI-24VDC
SPECIFICATIONS				
MAXIMUM LOAD	96W	2X96W	3X96W	4X96W
INPUT VOLTAGE	120-277VAC	120-277VAC	120-277VAC	120-277VAC
OUTPUT VOLTAGE	24VDC	24VDC	24VDC	24VDC
DIMENSIONS	12.4" X 3.12" X 2.18"	12.15" X 6.48" X 2.18"	14" X 10" X 3"	17" X 13" X 3"
CLASSIFICATION	CLASS 2	CLASS 2	CLASS 2	CLASS 2
IN-WALL MOUNTING	PSB-96W-UNI-24VDC-IW	PSB-2X96W-UNI-24VDC-IW	NA	NA
ELV DIMMING & CONTROLS				
LUTRON DIVA: DVELV-300P	•	•	•	•
LUTRON SKYLARK: SELV-300P	•	•	•	•
LUTRON RADIO RA2: RRD-6NA	•	•	•	•
LUTRON MAESTRO: MAELV-600	•	•	•	•
LEGRAND ADORNE: ADTP-703TUM4	•	•	•	•
0-10 DIMMING & CONTROLS				
PHILIPS SUNRISE: SR1200ZTUNV	•	•	•	•
LUTRON DIVA: DDTV-WH, DVSTV-WH	•	•	•	•
LUTRON NOVA T: NTSTV-DV-XX	•	•	•	•
LUTRON GRAFIX EYE QS: QSGRJ-XP	•	•	•	•
LUTRON RADIO RA2: RRD-10ND	•	•	•	•
LEVITON: LEV40050	•	•	•	•
LEVITON IP710-LFZ	•	•	•	•
LEGRAND: ADPD4FBL3P2W4	•	•	•	•
TRIAC DIMMING & CONTROLS				
LUTRON SKYLARK: S2-L-WH	•	•	•	•
LUTRON DIVA DVLV-600P-WH	•	•	•	•
LUTRON DIVA DVLV-603P-WH	•	•	•	•
LUTRON MAESTRO MALV-600-WH	•	•	•	•
LUTRON MAESTRO MALV-1000-WH	•	•	•	•
LUTRON MAESTRO MA-R-XX	•	•	•	•

- Flicker free dimming
- Aluminum casing for optimal heat dissipation
- Isolated output power per NEC and UL safety requirements
- UL & ETL recognized/ listed, meets UL 8750, 1310 requirements
- Auto-reset: short circuit, overload and thermal protection
- Class 2 power supply
- Efficient, High power factor > 0.90
- The Solid State Constant Voltage Uni-Power Supply is compatible with most commercially available Dimmers:
 - Triac Dimmer : (Forward Phase) Typically used for the dimming of Incandescent and Low Voltage Magnetic Transformers
 - ELV Dimmer : (Reverse Phase) Dimming of Electronic Low Voltage Transformers and Power Supply's used for LED lighting
 - 0-10 Dimmer : Dims the Low Voltage side of a 0-10 volt power supply commonly used in large scale lighting or commercial applications.
- The Uni-Power Supply is recommended with any Siemens/Murray brand of arc fault breaker to overcome the issues with tripping the breakers with an ELV LED Low Voltage Drivers.

PROJECT		FIXTURE TYPE		DATE	
---------	--	--------------	--	------	--

IN WALL MOUNTING OPTIONS

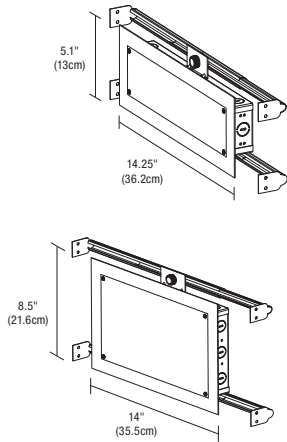

In-Wall Mounting Kit: Includes power supply, box cover and stud hangers for installing Junction Box in wall. Select "IW" in the options section of compatible power supply ordering codes if an In-Wall Mounting Kit is needed.

Ordering Codes 5.1 x 14.25 inch: PSB-40W-UNI-24VDC-IW
 PSB-60W-UNI-24VDC-IW
 PSB-96W-UNI-24VDC-IW

Ordering Codes 8.5 x 14.25 inch: PSB-2X40W-UNI-24VDC-IW
 PSB-2X60W-UNI-24VDC-IW
 PSB-2X96W-UNI-24VDC-IW

WIRING DIAGRAMS UNIVERSAL POWER SUPPLY

Application: ELV dimming for Static White and Warm Dim

Dimming: Dimmable with ELV dimmer: Legrand, Adorne ADTP703TU; Lutron: Diva DVELV-300P, Skylark SELV-300P, Maestro MAELV-600 and Radio Ra 2

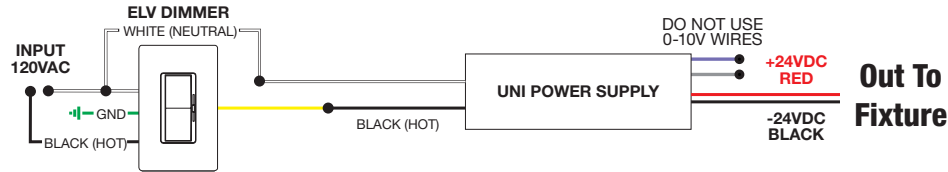

Application: 0-10V dimming for Static White

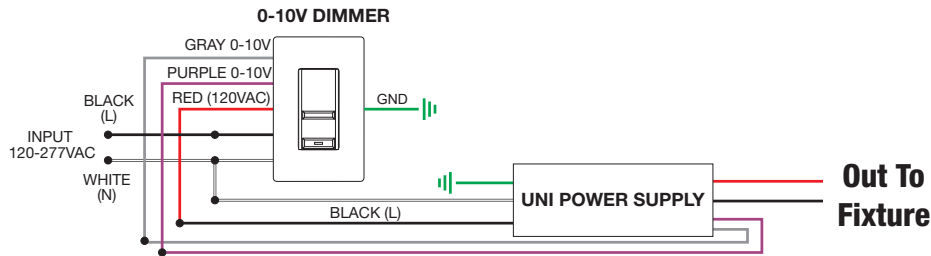

Dimming: Dimmable with 0-10V dimmer: Philips Sunrise: SR1200ZTUNV; Lutron Diva: DVTV-WH, DVSTV-WH; Lutron Nova T: NTSTV-DV-XX; Lutron Grafix EYE QS: QSGRJ-XP; Lutron Radio Ra2: RRD-10ND; Leviton: LEV40050; Leviton IP710-LFZ; Legrand: ADPD4FBL3P2W4



PROJECT		FIXTURE TYPE		DATE	
---------	--	--------------	--	------	--

INDOOR CONSTANT VOLTAGE REMOTE POWER SUPPLIES

24VDC, LUTRON ECOSYSTEM



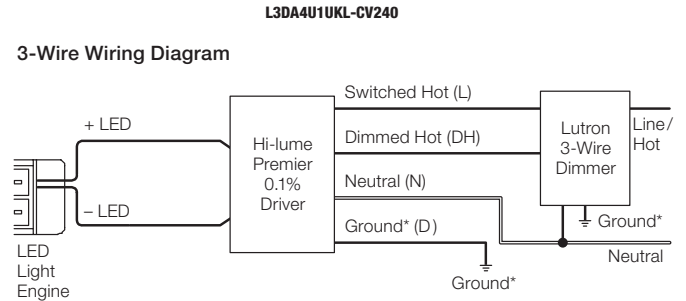
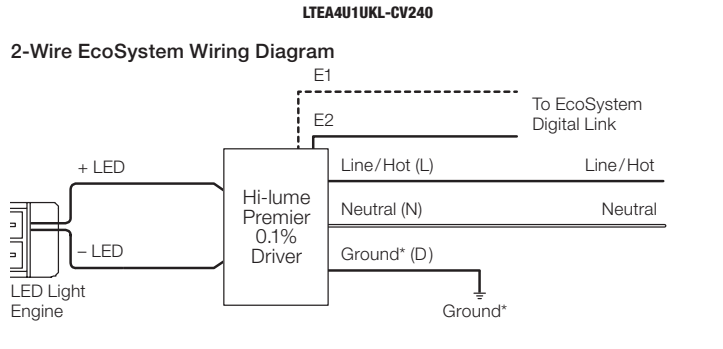

LUTRON HI-LUME® PREMIER .1% ECOSYSTEM®†			
ORDERING CODES	L3D0-96W24V-U	2-WIRE ECOSYSTEM LTEA4U1UKL-CV240	3-WIRE ECOSYSTEM L3DA4U1UKL-CV240
			
SPECIFICATIONS			
MAXIMUM LOAD	96W	5W-40W	5W-40W
INPUT VOLTAGE	120-277VAC	120-277VAC	120-277VAC
OUTPUT VOLTAGE	24VDC	24VDC	24VDC
DIMENSIONS	10.5" X 5.5" X 2"	4" X 4.89" X 2.62"	4" X 4.89" X 2.62"
CLASSIFICATION	CLASS 2	CLASS 2	CLASS 2
DIMMING AND CONTROLS			
RADIO RA2	•	•	•
HOMEWORKS QS	•	•	•
PHPM-3F-120	•	•	•
PHPM-3F-DV	•	•	•
BCI-0-10	•	•	•

†24K - 57K color temperatures are compatible with 0-10V, ELV, and Lutron Hi-lume® Power Supplies. Warm Dim (27D, 30D) color temperatures are only compatible with ELV power supplies.



PROJECT		FIXTURE TYPE		DATE	
---------	--	--------------	--	------	--

UNIVERSAL POWER SUPPLIES & RECOMMENDED DIMMERS†

ORDERING CODE	PSB-2X40W-UNI-24VDC	PSB-2X60W-UNI-24VDC	PSB-2X96W-UNI-24VDC	PSB-4X96W-UNI-24VDC
				
SPECIFICATIONS				
MAXIMUM LOAD	2X40W	2X60W	2X96W	4X96W
INPUT VOLTAGE	120-277VAC	120-277VAC	120-277VAC	120-277VAC
OUTPUT VOLTAGE	24VDC	24VDC	24VDC	24VDC
DIMENSIONS	12.15" X 6.48" X 2.18"	12.15" X 6.48" X 2.18"	12.15" X 6.48" X 2.18"	17" X 13" X 3"
CLASSIFICATION	CLASS 2	CLASS 2	CLASS 2	CLASS 2
IN-WALL MOUNTING	PSB-2X40W-UNI-24VDC-IW	PSB-2X60W-UNI-24VDC-IW	PSB-2X96W-UNI-24VDC-IW	NA
ELV DIMMING & CONTROLS				
LUTRON DIVA: DVELV-300P	•	•	•	•
LUTRON SKYLARK: SELV-300P	•	•	•	•
LUTRON RADIO RA2: RRD-6NA	•	•	•	•
LUTRON MAESTRO: MAELV-600	•	•	•	•
LEGRAND ADRNE: ADTP-703TUM4	•	•	•	•
0-10 DIMMING & CONTROLS				
PHILIPS SUNRISE: SR1200ZTUNV	•	•	•	•
LUTRON DIVA: DDTV-WH, DVSTV-WH	•	•	•	•
LUTRON NOVA T: NTSTV-DV-XX	•	•	•	•
LUTRON GRAFIX EYE QS: QSGRJ-XP	•	•	•	•
LUTRON RADIO RA2: RRD-10ND	•	•	•	•
LEVITON: LEV40050	•	•	•	•
LEVITON IP710-LFZ	•	•	•	•
LEGRAND: ADPD4FBL3P2W4	•	•	•	•
TRIAC DIMMING & CONTROLS				
LUTRON SKYLARK: S2-L-WH	•	•	•	•
LUTRON DVLV-600P-WH	•	•	•	•
LUTRON DVLV-603P-WH	•	•	•	•
LUTRON MALV-600-WH	•	•	•	•
LUTRON MALV-1000-WH	•	•	•	•
LUTRON MA-R-XX	•	•	•	•

- Flicker free dimming
- Aluminum casing for optimal heat dissipation
- Isolated output power per NEC and UL safety requirements
- UL & ETL recognized/ listed, meets UL 8750, 1310 requirements
- Auto-reset; short circuit, overload and thermal protection
- Class 2 power supply
- Efficient, High power factor > 0.90

- The Solid State Constant Voltage Uni-Power Supply is compatible with most commercially available Dimmers:
 - Triac Dimmer: (Forward Phase) Typically used for the dimming of Incandescent and Low Voltage Magnetic Transformers
 - ELV Dimmer: (Reverse Phase) Dimming of Electronic Low Voltage Transformers and Power Supply's used for LED lighting
 - 0-10 Dimmer: Dims the Low Voltage side of a 0-10 volt power supply commonly used in large scale lighting or commercial applications.
- The Uni-Power Supply is recommended with any Siemens/Murray brand of arc fault breaker to overcome the issues with tripping the breakers with an ELV LED Low Voltage Drivers.

IN WALL MOUNTING OPTIONS

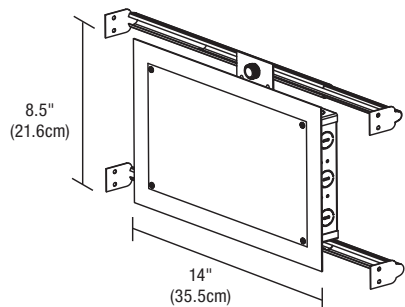

In-Wall Mounting Kit: Includes power supply, box cover and stud hangers for installing Junction Box in wall. Select "IW" in the options section of compatible power supply ordering codes if an In-Wall Mounting Kit is needed.

Ordering Codes 8.5 x 14.25 inch: PSB-2X40W-UNI-24VDC-IW, PSB-2X60W-UNI-24VDC-IW, PSB-2X96W-UNI-24VDC-IW

PROJECT		FIXTURE TYPE		DATE	
---------	--	--------------	--	------	--

SUSPENSION TM30 DATA

WITH REMOTE POWER, END FEED

TM-30-15 DATA: The data below is for SS2C, SS5C, SS7C, and SS10C bare LED Soft Strips. Consistent color temperatures throughout a single strip and among multiple strips is possible through a 3 phase binning process in which each order is inspected with a color meter to ensure uniformity.

2200K | Rf: 83.9 | Rg: 94.9
Color Vector Graphic

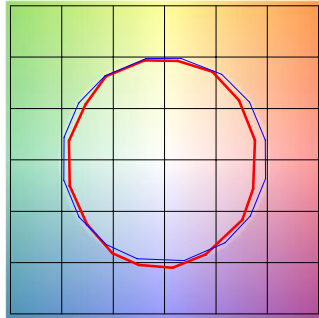

■ Test ■ Reference

		GRAPHIC SHIFTS %	
HUE BIN	Rf	CHROMA	HUE
1	77.6	-10.0%	1.8%
2	80.7	-7.5%	7.0%
3	79.5	-2.9%	8.9%
4	90.5	-3.1%	2.4%
5	93.9	-1.3%	1.9%
6	91.9	-0.9%	-0.2%
7	87.6	-6.3%	-2.7%
8	90.5	-5.4%	2.7%
9	83.8	-4.7%	6.5%
10	81.2	-2.5%	10.0%
11	83.3	3.9%	9.4%
12	86.4	5.6%	2.6%
13	86.2	4.5%	-12.4%
14	64.3	-1.0%	-21.9%
15	85.1	-4.4%	-7.5%
16	75.0	-9.9%	-12.0%

2400K | Rf: 91.2 | Rg: 96.8
Color Vector Graphic

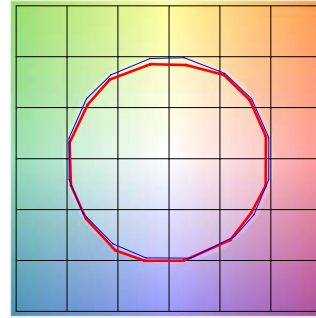

■ Test ■ Reference

		GRAPHIC SHIFTS %	
HUE BIN	Rf	CHROMA	HUE
1	92.0	-2.4%	1.5%
2	94.7	-2.1%	0.0%
3	95.4	-1.9%	-0.1%
4	88.7	-6.7%	-3.1%
5	92.8	-5.6%	1.0%
6	92.7	-3.4%	3.4%
7	89.9	-4.3%	4.1%
8	92.4	-1.4%	4.4%
9	89.0	-0.6%	5.8%
10	86.9	0.4%	6.2%
11	89.7	4.0%	5.4%
12	92.6	3.0%	-0.7%
13	90.9	1.1%	-7.0%
14	89.9	0.5%	-5.8%
15	92.1	-3.2%	0.1%
16	88.9	-1.7%	-6.3%

2700K | Rf: 87.7 | Rg: 96.1
Color Vector Graphic

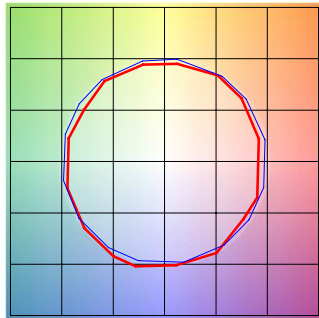

■ Test ■ Reference

		GRAPHIC SHIFTS %	
HUE BIN	Rf	CHROMA	HUE
1	86.4	-5.6%	2.3%
2	89.7	-3.3%	3.1%
3	90.5	-1.5%	3.8%
4	90.0	-4.3%	1.1%
5	92.9	-3.7%	0.2%
6	93.5	-2.5%	-0.8%
7	86.3	-7.2%	2.5%
8	90.7	-4.0%	3.2%
9	85.2	-2.4%	8.1%
10	81.7	0.9%	10.8%
11	85.4	4.5%	8.9%
12	88.7	5.7%	-1.4%
13	88.3	1.3%	-7.9%
14	85.1	2.4%	-10.4%
15	88.1	-4.8%	-2.7%
16	81.7	-4.3%	-10.9%

3000K | Rf: 88.1 | Rg: 99.7
Color Vector Graphic

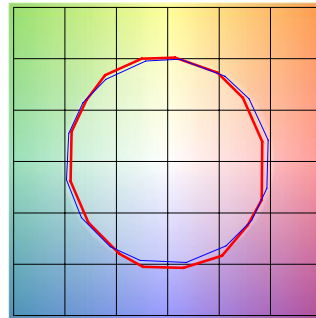

■ Test ■ Reference

		GRAPHIC SHIFTS %	
HUE BIN	Rf	CHROMA	HUE
1	87.7	-5.9%	-0.3%
2	87.9	-4.4%	4.3%
3	82.9	-1.2%	7.9%
4	89.9	0.6%	4.7%
5	92.7	3.0%	3.5%
6	92.7	3.6%	-1.7%
7	90.8	-1.3%	-4.4%
8	93.7	-2.5%	-2.2%
9	91.7	-3.7%	2.3%
10	85.5	-2.8%	7.8%
11	83.3	0.7%	11.0%
12	86.4	5.5%	3.8%
13	90.6	4.6%	-3.6%
14	85.6	5.9%	-8.4%
15	89.5	-0.6%	-5.7%
16	82.6	-2.7%	-12.0%

3500K | Rf: 86.1 | Rg: 95.5
Color Vector Graphic

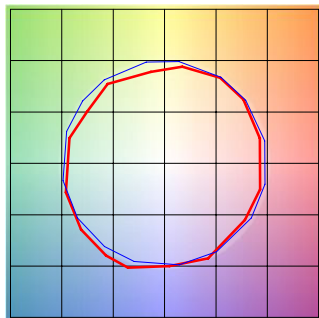

■ Test ■ Reference

		GRAPHIC SHIFTS %	
HUE BIN	Rf	CHROMA	HUE
1	86.6	-4.2%	3.4%
2	91.7	-1.4%	1.8%
3	94.9	-0.7%	0.4%
4	87.9	-4.5%	-4.1%
5	85.9	-10.3%	-2.7%
6	89.8	-5.2%	-0.4%
7	79.6	-9.5%	6.5%
8	87.6	-4.0%	5.7%
9	81.4	-0.5%	11.8%
10	78.3	3.3%	11.4%
11	85.7	6.3%	6.1%
12	86.3	7.1%	-4.6%
13	86.1	-0.7%	-9.6%
14	85.1	0.8%	-10.4%
15	83.4	-4.1%	-5.3%
16	82.5	-3.6%	-5.7%

4000K | Rf: 87.6 | Rg: 96.8
Color Vector Graphic

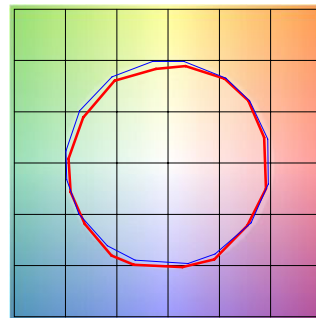

■ Test ■ Reference

		GRAPHIC SHIFTS %	
HUE BIN	Rf	CHROMA	HUE
1	89.0	-3.1%	2.1%
2	93.2	-0.9%	1.3%
3	94.3	-1.1%	0.7%
4	89.5	-4.0%	-2.3%
5	87.6	-7.8%	-1.8%
6	92.2	-4.6%	0.1%
7	87.4	-6.6%	3.6%
8	85.7	-3.8%	7.0%
9	81.5	-1.3%	12.4%
10	80.0	0.9%	11.4%
11	83.3	5.9%	8.7%
12	89.7	4.8%	-0.3%
13	88.5	2.4%	-6.3%
14	92.7	4.0%	-3.8%
15	86.1	-1.6%	-4.5%
16	85.0	-1.4%	-5.0%

PROJECT	FIXTURE TYPE	DATE
---------	--------------	------

SUSPENSION TM30 DATA

WITH REMOTE POWER, END FEED

TM-30-15 DATA: The data below is for SS2C, SS5C, SS7C, and SS10C bare LED Soft Strips. Consistent color temperatures throughout a single strip and among multiple strips is possible through a 3 phase binning process in which each order is inspected with a color meter to ensure uniformity.

5700K | Rf: 80.3 | Rg: 91.5

Color Vector Graphic

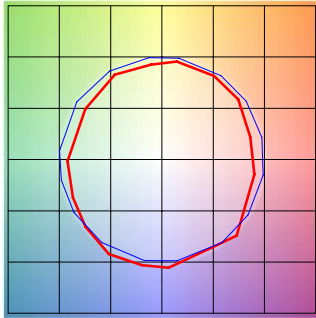

■ Test ■ Reference

HUE BIN	Rf	GRAPHIC SHIFTS %	
		CHROMA	HUE
1	73.8	-11.2%	2.6%
2	83.7	-5.5%	5.8%
3	84.2	-4.0%	5.5%
4	85.8	-3.5%	1.3%
5	85.3	-7.1%	0.6%
6	89.2	-5.8%	-2.2%
7	81.5	-10.7%	1.2%
8	75.7	-9.7%	8.5%
9	74.9	-7.8%	18.8%
10	67.8	-1.6%	18.0%
11	76.1	5.5%	12.0%
12	90.8	4.9%	-1.6%
13	83.6	5.0%	-9.5%
14	81.7	-1.2%	-10.0%
15	69.0	2.0%	-22.8%
16	83.2	-8.5%	-1.0%

2700D | Rf: 89.5 | Rg: 100.8

Color Vector Graphic

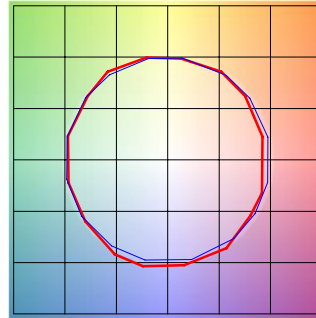

■ Test ■ Reference

HUE BIN	Rf	GRAPHIC SHIFTS %	
		CHROMA	HUE
1	88.8	-5.1%	1.4%
2	89.8	-2.7%	4.1%
3	87.2	0.3%	5.9%
4	92.3	-0.9%	1.0%
5	93.3	1.5%	1.7%
6	92.4	3.6%	-0.2%
7	92.2	-0.9%	-2.4%
8	96.7	-0.4%	-1.1%
9	92.3	-1.2%	3.7%
10	88.9	-0.0%	6.1%
11	86.4	5.1%	7.4%
12	88.2	6.3%	-0.9%
13	87.2	3.8%	-8.1%
14	84.2	3.8%	-11.0%
15	89.8	-2.6%	-4.3%
16	82.7	-3.4%	-11.1%

3000D | Rf: 89.8 | Rg: 101.4

Color Vector Graphic

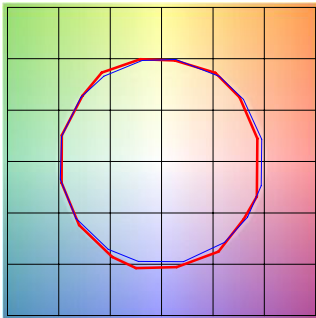

■ Test ■ Reference

HUE BIN	Rf	GRAPHIC SHIFTS %	
		CHROMA	HUE
1	90.2	-4.2%	1.5%
2	90.9	-2.0%	3.7%
3	87.9	0.8%	5.5%
4	92.1	-0.9%	0.6%
5	93.0	1.5%	1.6%
6	92.2	3.9%	-0.2%
7	92.1	-0.3%	-2.0%
8	96.7	0.0%	-1.2%
9	92.5	-0.6%	3.7%
10	88.3	1.1%	7.0%
11	87.2	4.1%	7.4%
12	87.2	6.7%	-1.0%
13	88.2	3.8%	-7.2%
14	85.3	4.3%	-9.9%
15	90.9	-2.2%	-3.6%
16	83.4	-2.2%	-11.2%

PROJECT	FIXTURE TYPE	DATE
---------	--------------	------