



## DESCRIPTION

**Light Channel 0.6" Millwork Recessed System** is a made-to-order complete fixture, purchased in nominal increments of 2, 3, 5, 8 and 10 inches. Light Channels may be ordered from 12 inches all the way up to 120 inches (10ft). For longer continuous runs, see DIY spec sheet.

## FEATURES AND BENEFITS

- 24VDC Commercial Grade LED Soft Strip provides up to 95+ CRI values offers excellent Designer Luxury Grade color rendering and fits inside a slim profile aluminum extrusion.
- Low voltage up to 100 watt. Class 2 wiring, no need for conduit pipe.
- Power Consumption Options: 2.5W | 4.4W | 4.8W | 7.3W /FT.
- 7 LEDs per cutting increment provides 87.5% efficiency compared to six LEDs at only 75%. Solid State Power Supply offer 85-90% efficiency compared to magnetic at 80%. The combination of seven LEDs and a Solid State Power Supply increases the efficiency up to 22%.

## LENS OPTIONS:

- **(C)** Clear Lens provides maximum illumination use of a 26-Degree transparent clear lens, LEDs diodes will show.
- **(CLW)** Clear Lens White Louver
- **(CLB)** Clear Lens Black Louver
- **(D)** White Diffuser Lens projects clean lines of light 61-Degrees eliminating LED dots.
- **(DLW)** Diffused Lens White Louver
- **(DLB)** Diffused Lens Black Louver
- **(G)** DIFFUSER LENS WITH GEL COLOR FILTER (**PROVIDED BY CUSTOMER**) Clear and Diffuser Lens are Gel Color Filter Suitable allowing for color personalization. Zircon LED Gel filters recommended. Purchase Gel Lens from [www.leefilters.com](http://www.leefilters.com). See manufacturer spec sheet for more information.

## INCLUDED COMPONENTS

- 96-inch of Solderless Snap & Light Power Connector (Included 1 per fixture). Order extra as needed based on your installation requirements.
- Mounting Clips (Included with every 2 feet of Channel)

## APPLICATIONS

- Indoor only - Millwork Recessed Under Cabinet Lighting, Millwork Above Cabinet Up-Lighting, Recessed Toe Kick Lighting, Millwork Recessed Cove Lighting, and Millwork Recessed General Illumination for a clean line of light.

## ADDITIONAL ACCESSORIES - (SOLD SEPARATELY)

- Mounting Clips (Included with every 2 feet of Channel)
- Solderless Snap & Light Power/Jumper Connector
- Soft Strip Solderless Snap & Light Straight Joiner
- Solderless Light Channel Connectors L, T, X

## REMOTE POWER SUPPLIES\*, DIMMERS & CONTROLS (SOLD SEPARATELY):

- UNIVERSAL POWER SUPPLY (TRIAC, ELV, 0-10v) Title 24 Compliant
- Electronic Low Voltage dimming (ELV)
- 0-10V Volt Dimming (0-10v) Title 24 Compliant
- 2XK Dynamic Color Changing (DMX) Title 24 Compliant
- Lutron HI-Lume Title 24 Compliant
- Remote Power Uni-Driver up to 96 watts Title 24 compliant, Class 2 wiring options.

\*In-Wall Mounting Kits available for select power supplies.

Product	Wattage	Nominal Size	Finish
<b>LCMW.6</b>	<b>2W</b>	<b>60</b>	<b>SA</b>
<b>LCMW.6</b> Light Channel 0.6" Millwork	<b>2W</b> 2.5 watts <b>5W</b> 4.4 watts <b>7W</b> 7.3 watts	<b>12-120</b> Order in 12 inch increments up to 120 inches. May be ordered in 3, 5, 8 or 10 inch increments	<b>SA</b> Satin Aluminum <b>BZ</b> Bronze <b>WH</b> White
Product	Wattage	Nominal Size	Finish
<b>D</b>	<b>22K</b>	<b>D</b>	<b>SA</b>
<b>D</b> Diffuser Lens <b>C</b> Clear Lens <b>G</b> Gel Lens <b>DLW</b> Diffused Lens with White Louver <b>DLB</b> Diffused Lens with Black Louver <b>CLW</b> Clear Lens with White Louver <b>CLB</b> Clear Lens with Black Louver	<b>20K</b> 2000K Sunset <b>22K</b> 2200K Candle White <b>24K</b> 2400K Very Warm White <b>27K</b> 2700K Incandescent White <b>27D</b> 2700K Warm Dim (5W only) <b>30K</b> 3000K Warm White <b>30D</b> 3000K Warm Dim (5W only) <b>35K</b> 3500K Neutral White <b>40K</b> 4000K Cool White <b>57K</b> 5700K Daylight White <b>2K4K</b> 2000K - 4000K Dynamic/Tunable White		

PROJECT	FIXTURE TYPE	DATE
---------	--------------	------

# LIGHT CHANNEL COMPLETE FIXTURE 0.6" MILLWORK

24VDC RECESSED

REV02.26.20

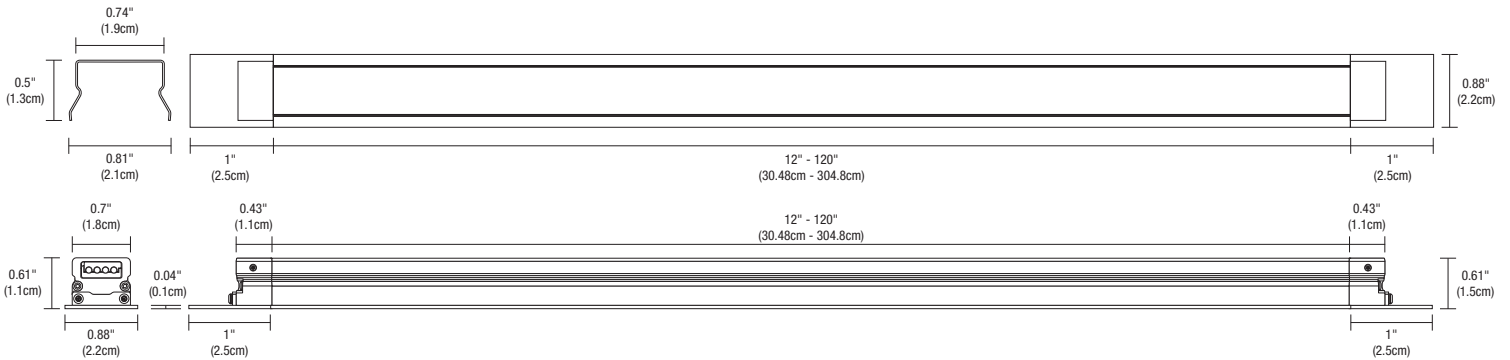

## INCLUDED COMPONENTS Lens Options and Lamp Data for indoor Light Channel 0.6" Surface Mount

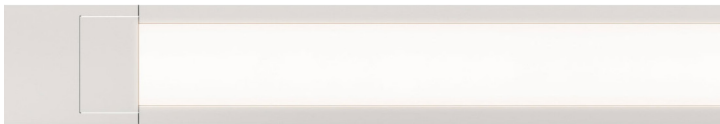

**LCMW.6 LIGHT CHANNEL 61° DIFFUSER LENS** White Diffuser Lens projects clean lines of light, eliminating LED dots



**LCMW.6 LIGHT CHANNEL 26° CLEAR LENS** Clear Lens provides maximum light levels and will show slight LED dots



**LCMW.6 LIGHT CHANNEL DIFFUSE WHITE LENS WITH WHITE LOUVER**



**LCMW.6 LIGHT CHANNEL DIFFUSER LENS WITH BLACK LOUVER**



**LCMW.6 LIGHT CHANNEL CLEAR LENS WITH WHITE LOUVER**



**LCMW.6 LIGHT CHANNEL CLEAR LENS WITH BLACK LOUVER**



**LCMW.6 LIGHT CHANNEL DIFFUSER LENS WITH GEL COLOR FILTER (PROVIDED BY CUSTOMER)**

Clear and Diffuser Lens are Gel Color Filter Suitable allowing for color personalization. Zircon LED Gel filters are recommended and can be purchased from [www.leafilters.com](http://www.leafilters.com). Gel filter life is 5,000 hours before needing to be changed

Lamp Life is 50,000 hours

LIGHT CHANNEL 0.6 MILLWORK																											
WATTS PER FOOT	2w (2.5 watts)							5w (4.4 watts)							7w (7.5 watts)												
COLOR TEMPERATURE	22K	24K	27K	30K	35K	40K	57K	22K	24K	27K	27D*	30K	27D*	35K	40K	57K	22K	24K	27K	30K	35K	40K	57K				
CLEAR LENS LUMENS PER FOOT LM/FT	129.4	143.6	157.8	172.5	197.5	214.8	228.6	207.9	230.75	253.6	372.0	277.2	406.0	317.4	345.1	367.3	300.4	333.45	366.5	400.5	458.6	498.6	530.7				
CLEAR LENS LUMENS PER WATT LM/W	51.8	57.45	63.1	69.0	79.0	85.9	91.4	47.3	52.5	57.7	77.5	63.0	84.7	72.1	78.4	83.5	40.1	44.5	48.9	53.4	61.1	66.5	70.8				
DIFFUSER LENS LUMENS PER FOOT LM/FT	111.0	122.7	135.4	148.0	169.5	184.3	196.1	174.9	194.15	213.4	320.0	233.2	350.0	267.0	290.3	309.0	241.9	268.5	295.1	322.5	369.3	401.5	427.3				
DIFFUSER LENS LUMENS PER WATT LM/W	44.4	49.3	54.2	59.2	67.8	73.7	78.4	39.8	44.05	48.5	66.7	53.0	72.9	60.7	66.0	70.2	32.3	35.85	39.4	43.0	49.2	53.5	57.0				
RF	83.9	85.8	87.7	88.1	86.1	87.6	80.3	83.9	85.8	87.7	89.5	88.1	100.8	86.1	87.6	80.3	83.9	85.8	87.7	88.1	86.1	87.6	80.3				
RG	94.9	95.5	96.1	99.7	95.5	96.8	91.5	94.9	95.5	96.1	100.8	99.7	101.4	95.5	96.8	91.5	94.9	95.5	96.1	99.7	95.5	96.8	91.5				
CRI	85+	90+	95+	95+	85+	84	84	85+	90+	95+	95+	95+	95+	85+	84	84	85+	90+	95+	95+	85+	84	84				

## FOOT CANDLE CHARTS

30K 60° 5W DIFFUSER LENS		
DISTANCE	BEAM	FOOT CANDLE
12in	15in	201 FC
18in	21in	110 FC
24in	29in	70 FC
36in	42in	35 FC

30K 60° 5W CLEAR LENS		
DISTANCE	BEAM	FOOT CANDLE
12in	15in	273 FC
18in	21in	145 FC
24in	29in	91 FC
36in	42in	44 FC

\*Foot Candle Data is based off 4' Channel.

PROJECT	FIXTURE TYPE	DATE
---------	--------------	------



# LIGHT CHANNEL COMPLETE FIXTURE 0.6" MILLWORK

24VDC RECESSED



REV02.26.20

## LENGTH CHART Actual lengths for Light Channel 0.6" Millwork

20K, 22K, 24K, 27K, 30K, 35K, 40K, 57K & 2K4K							
Ordering Code (Nominal Size)	Illuminated Length (Inches)	Overall Recessed Length (Inches)	Overall Length with End Caps (Inches)	Ordering Code (Nominal Size)	Illuminated Length (Inches)	Overall Recessed Length (Inches)	Overall Length with End Caps (Inches)
12	12.0	13.0	14.0	68	67.2	68.2	69.2
15	14.4	15.4	16.4	70	69.6	70.6	71.6
17	16.8	17.8	18.8	72	72.0	73.0	74.0
20	19.2	20.2	21.2	75	74.4	75.4	76.4
22	21.6	22.6	23.6	77	76.8	77.8	78.8
24	24.0	25.0	26.0	80	79.2	80.2	81.2
27	26.4	27.4	28.4	82	81.6	82.6	83.6
29	28.8	29.8	30.8	84	84.0	85.0	86.0
32	31.2	32.2	33.2	87	86.4	87.4	88.4
34	33.6	34.6	35.6	89	88.8	89.8	90.8
36	36.0	37.0	38.0	92	91.2	92.2	93.2
39	38.4	39.4	40.4	94	93.6	94.6	95.6
41	40.8	41.8	42.8	96	96.0	97.0	98.0
44	43.2	44.2	45.2	99	98.4	99.4	100.4
46	45.6	46.6	47.6	101	100.8	101.8	102.8
48	48.0	49.0	50.0	104	103.2	104.2	105.2
51	50.4	51.4	52.4	106	105.6	106.6	107.6
53	52.8	53.8	54.8	108	108.0	109.0	110.0
56	55.2	56.2	57.2	111	110.4	111.4	112.4
58	57.6	58.6	59.6	113	112.8	113.8	114.8
60	60.0	61.0	62.0	116	115.2	116.2	117.2
63	62.4	63.4	64.4	118	117.6	118.6	119.6
65	64.8	65.8	66.8	120	120.0	121.0	122.0

27D, 30D WARM DIM							
Ordering Code (Nominal Size)	Illuminated Length (Inches)	Overall Recessed Length (Inches)	Overall Length with End Caps (Inches)	Ordering Code (Nominal Size)	Illuminated Length (Inches)	Overall Recessed Length (Inches)	Overall Length with End Caps (Inches)
12	12	13	14	69	69	70	71
15	15	16	17	72	72	73	74
18	18	19	20	75	75	76	77
21	21	22	23	78	78	79	80
24	24	25	26	81	81	82	83
27	27	28	29	84	84	85	86
30	30	31	32	87	87	88	89
33	33	34	35	90	90	91	92
36	36	37	38	93	93	94	95
39	39	40	41	96	96	97	98
42	42	43	44	99	99	100	101
45	45	46	47	102	102	103	104
48	48	49	50	105	105	106	107
51	51	52	53	108	108	109	110
54	54	55	56	111	111	112	113
57	57	58	59	114	114	115	116
60	60	61	62	117	117	118	119
63	63	64	65	120	120	121	122
66	66	67	68				

PROJECT		FIXTURE TYPE		DATE	
---------	--	--------------	--	------	--

## COMPONENTS Light Channel 0.6" Millwork System Overview

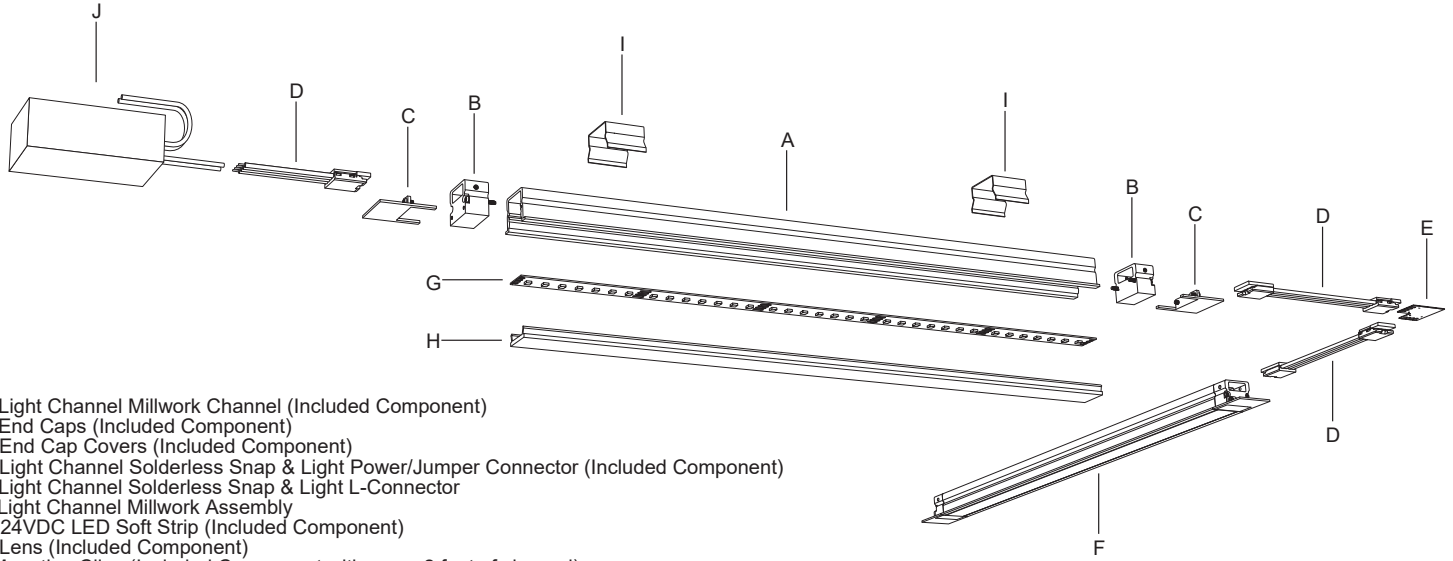

- A) Light Channel Millwork Channel (Included Component)
- B) End Caps (Included Component)
- C) End Cap Covers (Included Component)
- D) Light Channel Solderless Snap & Light Power/Jumper Connector (Included Component)
- E) Light Channel Solderless Snap & Light L-Connector
- F) Light Channel Millwork Assembly
- G) 24VDC LED Soft Strip (Included Component)
- H) Lens (Included Component)
- I) Mounting Clips (Included Component with every 2 feet of channel)
- J) Remote Power Supply (PSB-60L-ELV-24VDC shown) (Sold Separately)

## WIRING DIAGRAM Electronic Low Voltage (ELV) dimming for Light Channel .6 Millwork System

### APPLICATION

ELV dimming for Light Channel 0.6" Millwork

### POWER SUPPLY

120VAC input, 24VDC 100 watt output PSB-100W-ELV-24VDC

### DIMMING

Dimmable with Low Voltage Electronic Dimmer using Power Supply above. See Power Supply spec sheet for additional details. Lutron: Diva DVELV-300P; Skylark SELV-300P; Maestro MAELV-600 dimmers are recommended.

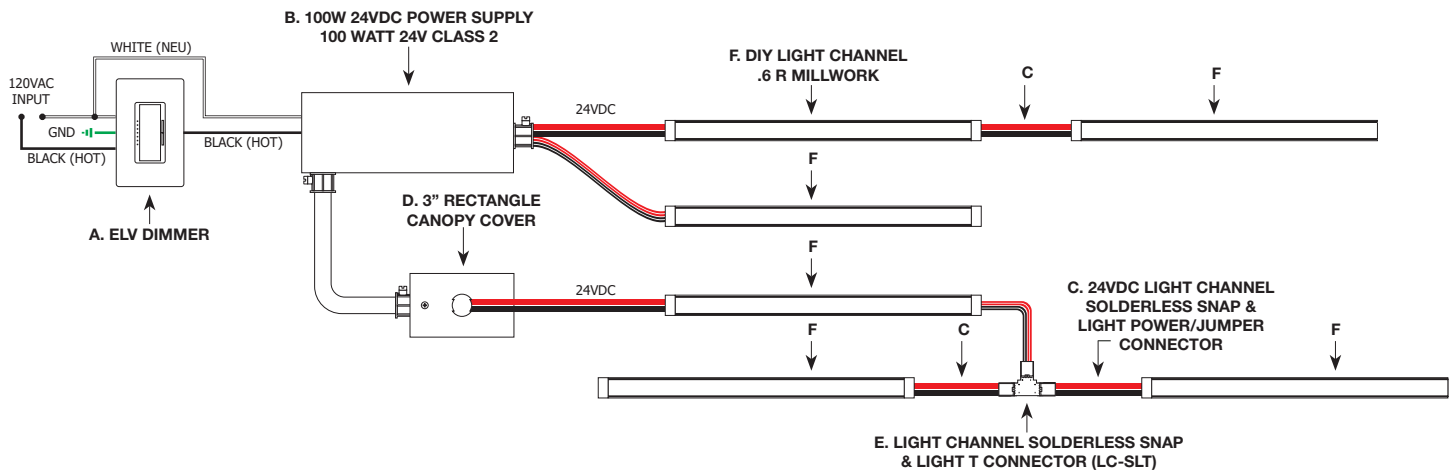

PROJECT	FIXTURE TYPE	DATE
---------	--------------	------

**ACCESSORIES** Light Channel 0.6" Millwork, order based on lighting design or as replacement parts

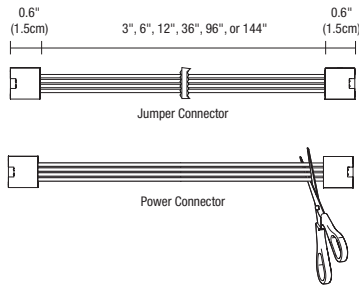

### 24VDC LIGHT CHANNEL SOLDERLESS SNAP & LIGHT JUMPER/POWER CONNECTOR

Power Connector is included, may be ordered as a Jumper Connector. Join sections of Light Channel using Solderless Snap & Light L, T, or X Connectors below. To use as a Power Connector, cut and strip the wires.

System	Product	Length
<b>LC</b>	<b>SLC</b>	<b>3IN</b>
LC Light Channel	SLC Solderless Snap & Light Jumper/Power Connector	3IN 3" 6IN 6" 12IN 12" 36IN 36" 96IN 96" 144IN 144"

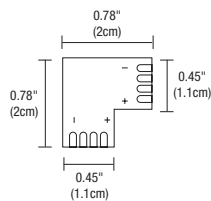
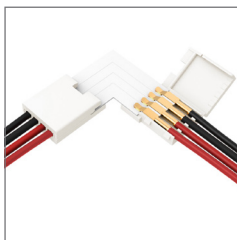

### LIGHT CHANNEL SOLDERLESS SNAP & LIGHT L-CONNECTOR

Conducts power to two sections of LED Soft Strip within the Light Channel. Requires Light Channel Solderless Snap & Light Power/Jumper Connector for use (sold separately).

System	Product
<b>LC</b>	<b>SLL</b>
LC Light Channel	SLL Snap & Light L-Connector

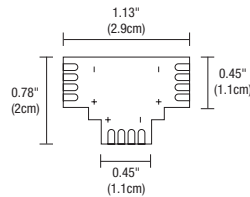
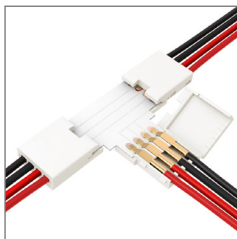

### LIGHT CHANNEL SOLDERLESS SNAP & LIGHT T-CONNECTOR

Conducts power to three sections of LED Soft Strip within the Light Channel. Requires Light Channel Solderless Snap & Light Power/Jumper Connector for use (sold separately).

System	Product
<b>LC</b>	<b>SLT</b>
LC Light Channel	SLT Snap & Light T-Connector

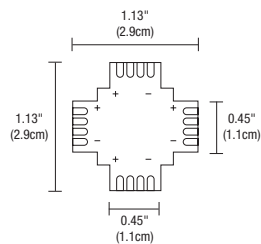
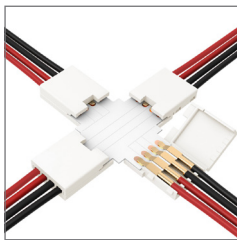

### LIGHT CHANNEL SOLDERLESS SNAP & LIGHT X-CONNECTOR

Conducts power to four sections of LED Soft Strip within the Light Channel. Requires Light Channel Solderless Snap & Light Power/Jumper Connector for use (sold separately).

System	Product
<b>LC</b>	<b>SLX</b>
LC Light Channel	SLX Snap & Light X-Connector

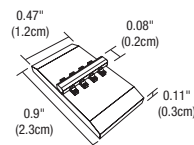

### SOFT STRIP SOLDERLESS SNAP & LIGHT STRAIGHT JOINER

Joins two sections of LED Soft Strip in the Channel. Used when replacing a section of LED Soft Strip.

System	Product
<b>CH</b>	<b>SLC</b>
CH Channel	SLC Snap & Light Straight Joiner

**ACCESSORIES:** Light Channel 0.6" Millwork, order based on lighting design or as replacement parts

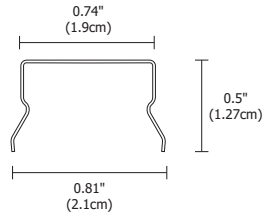

### MOUNTING CLIP

Light Channel comes with standard Mounting Clips. LCMW.6 Mounting Clips are provided with every 2' of Light Channel.

System	Product
<b>LCMW.6</b>	<b>MCL</b>
LCMW.6 Light Channel 0.6" Surface Millwork	MCL Mounting Clip



**4RD-WH**

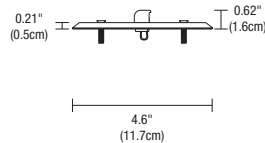
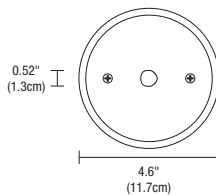

### CANOPY COVER & SPLICE BOX

Use for remote located power supply. The 3 inch rectangle or 4 inch round white canopy covers the electrical box and feeds wires for Light Channel. The Splice Box provides a safe enclosure for low voltage connections.

Product	Finish
<b>3RE</b>	<b>WH</b>
<b>3RE</b> 3 Inch Rectangle Canopy Cover <b>4RD</b> 4 Inch Round Canopy Cover <b>1RB</b> 1 Inch Rectangle Splice Box	<b>WH</b> White



**3RE-WH**

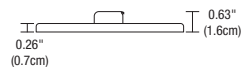
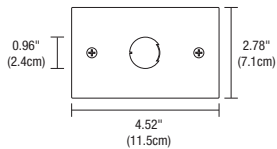

**1RB-WH**

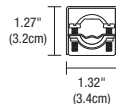
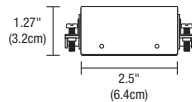

PROJECT	FIXTURE TYPE	DATE
---------	--------------	------



**IN WALL MOUNTING OPTIONS**

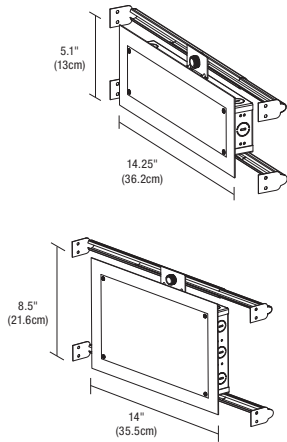

**In-Wall Mounting Kit:** Includes power supply, box cover and stud hangers for installing Junction Box in wall. Select "IW" in the options section of compatible power supply ordering codes if an In-Wall Mounting Kit is needed.

**Ordering Codes 5.1 x 14.25 inch:** PSB-40W-UNI-24VDC-IW  
PSB-60W-UNI-24VDC-IW  
PSB-96W-UNI-24VDC-IW

**Ordering Codes 8.5 x 14.25 inch:** PSB-2X40W-UNI-24VDC-IW  
PSB-2X60W-UNI-24VDC-IW  
PSB-2X96W-UNI-24VDC-IW

**WIRING DIAGRAMS UNIVERSAL POWER SUPPLY**

**Application:** Triac dimming for two power supplies, use for Static White, Dynamic/Tunable White 2000K-4000K

**Dimming:** Dimmable with Triac dimmer: Lutron: Skylark S2-L

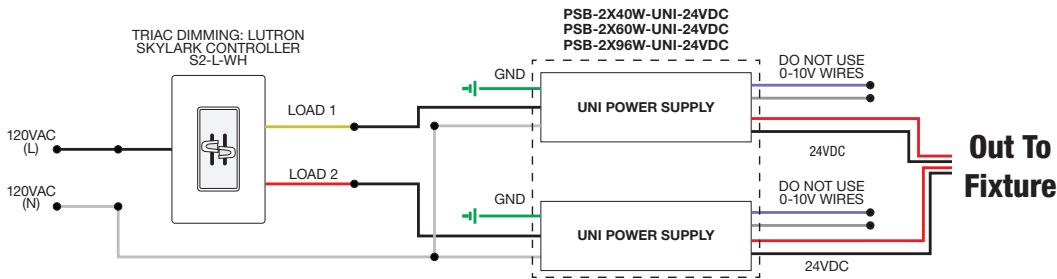

**Application:** ELV dimming for Static White and Warm Dim

**Dimming:** Dimmable with ELV dimmer: Legrand, Adorne ADTP703TU; Lutron: Diva DVELV-300P, Skylark SELV-300P, Maestro MAELV-600 and Radio Ra 2

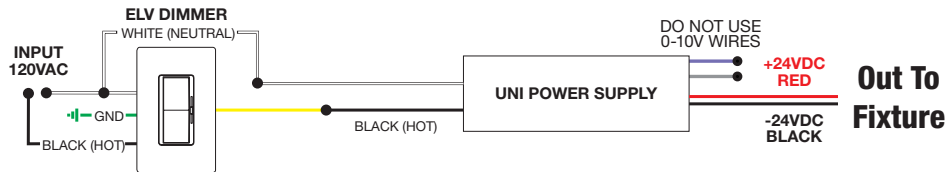

**Application:** 0-10V dimming for Static White

**Dimming:** Dimmable with 0-10V dimmer: Philips Sunrise: SR1200ZTUNV; Lutron Diva: DVTV-WH, DVSTV-WH; Lutron Nova T: NTSTV-DV-XX; Lutron Grafix EYE QS: QSGRJ-XP; Lutron Radio Ra2: RRD-10ND; Leviton: LEV40050; Leviton IP710-LFZ; Legrand: ADPD4FBL3P2W4

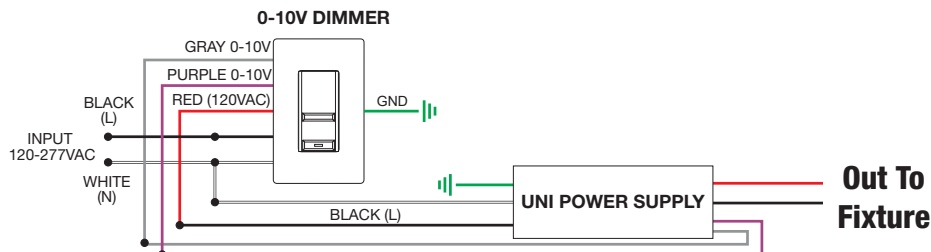

PROJECT	FIXTURE TYPE	DATE
---------	--------------	------



# INDOOR CONSTANT VOLTAGE REMOTE POWER SUPPLIES

24VDC, DYNAMIC/TUNABLE WHITE POWER SUPPLIES WITH DMX DRIVER

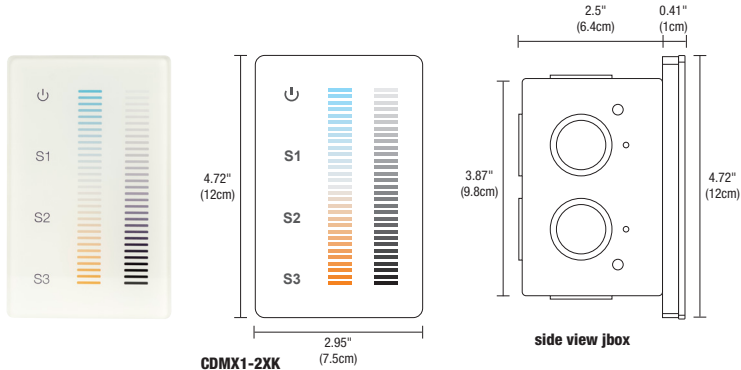

### Description:

The Tunable White Touch Controller is a full-touch controller that offers fast and accurate color temperature adjustment and independent brightness dimming of a single zone. Designed for dynamic/tunable white and dual-color LED installations, this controller adjusts color temperature and brightness for warm and cool white LEDs. It also saves 3 preset scenes. Independent smooth dimming with 256 level brightness adjustment enables the DMX controller to achieve many colors within the full LED spectrum. Controller includes a power adapter that fits in junction box (not included) behind the controller. It contains an illuminated back light when powered off.

### Applications:

Indoor

### Power Input:

120-240VAC

### Installation:

Fits in a single gang 2.5 inch deep junction box, not to be used with a multi gang box

### Output Signal:

USITT DMX 512 (1990)

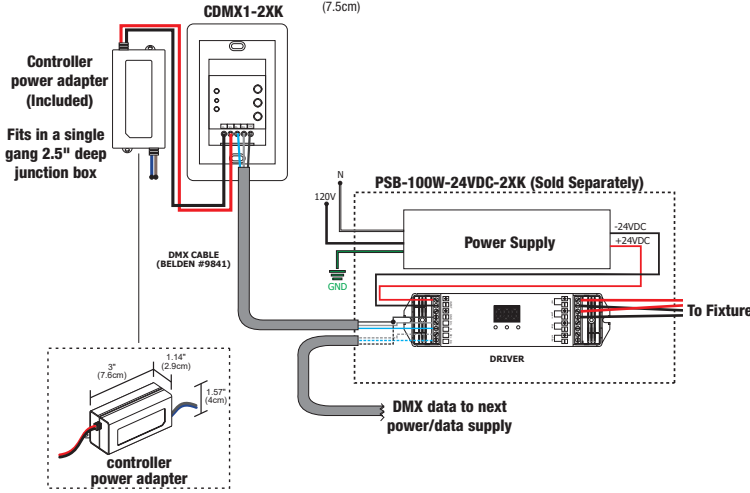

Product	Type	Finish
<b>CDMX1</b>	<b>2XK</b>	<b>WH</b>
CDMX1 DMX Single Zone Touch Controller	2XK 2 X Kelvin	WH White

## DYNAMIC COLOR CHANGING (DMX) POWER SUPPLIES & RECOMMENDED CONTROLLERS<sup>†</sup>

ORDERING CODE	PSB-100W-24VDC-2XK	PSB-2X100W-24VDC-2XK	PSB-3X100W-24VDC-2XK	PSB-4X100W-24VDC-2XK
<b>SPECIFICATIONS</b>				
<b>MAXIMUM LOAD</b>	100W	2X100W	3X100W	4X100W
<b>INPUT VOLTAGE</b>	120-277VAC	120-277VAC	120-277VAC	120-277VAC
<b>OUTPUT VOLTAGE</b>	24VDC	24VDC	24VDC	24VDC
<b>DIMENSIONS</b>	12.4" X 6.48" X 2.18"	14" X 10" X 3"	17" X 10" X 3"	17" X 10" X 3"
<b>CLASSIFICATION</b>	CLASS 2	CLASS 2	CLASS 2	CLASS 2
<b>IN-WALL MOUNTING</b>	PSB-100W-24VDC-2XK-IW	NA	NA	NA
<b>DMX DYNAMIC/TUNABLE WHITE DIMMING &amp; CONTROLS</b>				
<b>TUNABLE WHITE TOUCH CONTROLLER (CDMX1-2XK)</b>	•	•	•	•

- Flicker free dimming
- Aluminum casing for optimal heat dissipation
- Isolated output power per NEC and UL safety requirements
- UL & ETL recognized/ listed, meets UL 8750, 1310 requirements
- Auto-reset; short circuit, overload and thermal protection
- Class 2 power supply
- Efficient, High power factor > 0.90

- The Solid State Constant Voltage Uni-Power Supply is compatible with most commercially available Dimmers:
  - Triac Dimmer: (Forward Phase) Typically used for the dimming of Incandescent and Low Voltage Magnetic Transformers
  - ELV Dimmer: (Reverse Phase) Dimming of Electronic Low Voltage Transformers and Power Supply's used for LED lighting
  - 0-10 Dimmer: Dims the Low Voltage side of a 0-10 volt power supply commonly used in large scale lighting or commercial applications.
- The Uni-Power Supply is recommended with any Siemens/Murray brand of arc fault breaker to overcome the issues with tripping the breakers with an ELV LED Low Voltage Drivers.



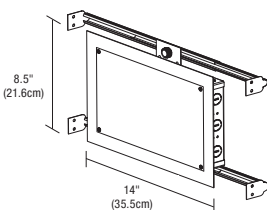

## IN WALL MOUNTING OPTIONS





**8.5 x 14 inch In-Wall Mounting Kit:** Includes power supply, box cover and stud hangers for installing Junction Box in wall. Select "IW" in the options section of compatible power supply ordering codes if an In-Wall Mounting Kit is needed.

**Ordering Codes:** PSB-100W-24VDC-2XK-IW

PROJECT	FIXTURE TYPE	DATE
---------	--------------	------

0-10 VOLT (010) POWER SUPPLIES & RECOMMENDED DIMMERS†				
ORDERING CODE	PSB-25W-010-24VDC 	PSB-60W-010-24VDC 	PSB-96W-010-24VDC 	PSB-2X96W-010-24VDC 
SPECIFICATIONS				
MAXIMUM LOAD	25W	60W	96W	2X96W
INPUT VOLTAGE	120VAC	120-277VAC	120-277VAC	120-277VAC
OUTPUT VOLTAGE	24VDC	24VDC	24VDC	24VDC
DIMENSIONS	12.4" X 3.12" X 2.18"	12.4" X 3.12" X 2.18"	12.4" X 3.12" X 2.18"	12.15" X 6.48" X 2.18"
CLASSIFICATION	CLASS 2	CLASS 2	CLASS 2	CLASS 2
IN-WALL MOUNTING	PSB-25W-010-24VDC-IW	PSB-60W-010-24VDC-IW	PSB-96W-010-24VDC-IW	PSB-2X96W-010-24VDC-IW

0-10 VOLT (010) POWER SUPPLIES & RECOMMENDED DIMMERS†			
ORDERING CODE	PSB-3X96W-010-24VDC 	PSB-4X96W-010-24VDC 	
SPECIFICATIONS			
MAXIMUM LOAD	3X96W	4X96W	
INPUT VOLTAGE	120-277VAC	120-277VAC	
OUTPUT VOLTAGE	24VDC	24VDC	
DIMENSIONS	14" X 10" X 3"	17" X 13" X 3"	
CLASSIFICATION	CLASS 2	CLASS 2	
IN-WALL MOUNTING	N/A	N/A	
DIMMING & CONTROLS			
PHILIPS SUNRISE: SR1200ZTUNV	•		•
LUTRON DIVA: DVTV-WH, DVSTV-WH	•		•
LUTRON NOVA T: NTSTV-DV-XX	•		•
LUTRON GRAFIX EYE QS: QSGRJ-XP	•		•
LUTRON RADIO RA2: RRD-10ND	•		•
LEVITON: LEV40050	•		•
LEVITON IP710-LFZ	•		•
LEGRAND: ADPD4FBL3P2W4	•		•

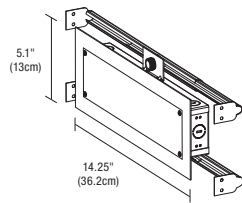

**5.1 x 14.25 inch In-Wall Mounting Kit:** Includes power supply, box cover and stud hangers for installing Junction Box in wall. Select "IW" in the options section of compatible power supply ordering codes if an In-Wall Mounting Kit is needed.

**Ordering Codes:** PSB-25W-010-24VDC-IW, PSB-60W-010-24VDC-IW, PSB-96W-010-24VDC-IW

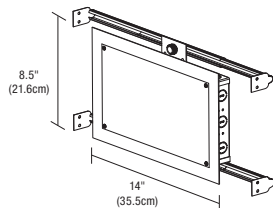

**8.5 x 14 inch In-Wall Mounting Kit:** Includes power supply, box cover and stud hangers for installing Junction Box in wall. Select "IW" in the options section of compatible power supply ordering codes if an In-Wall Mounting Kit is needed.

**Ordering Codes:** PSB-2X96W-010-24VDC-IW

PROJECT	FIXTURE TYPE	DATE
---------	--------------	------

**SAMPLE WIRING DIAGRAMS 24VDC 010**

**Application:** 0-10V Dimming Applications For Static White and Dynamic Tunable White 0-10V Dual Dimming.

**Dimming:** Dimmable with 0-10V dimmers: Signify (Phillips) Sunrise: SR1200ZTUNV, Leviton Dimmers: LEV40050, IP710-LFZ, \*IP710-DLZ \*(Built in LED locator light) Legrand Dimmer: ADPD4FBL3P2W4 Lutron Systems: Lutron GRAFIX Eye QS Main Unit (with DRX-TVI) Radio Ra2 (with GRX-TVI)

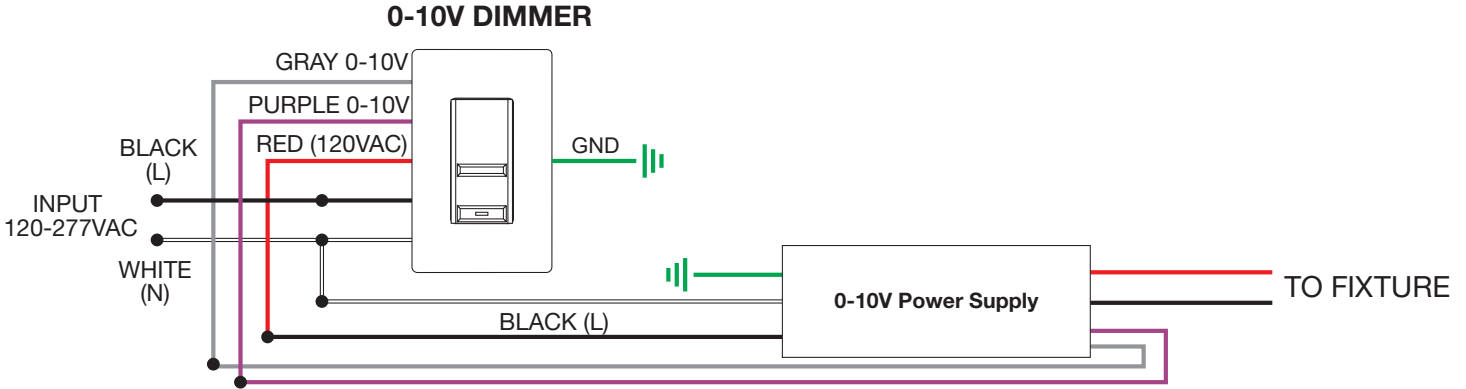

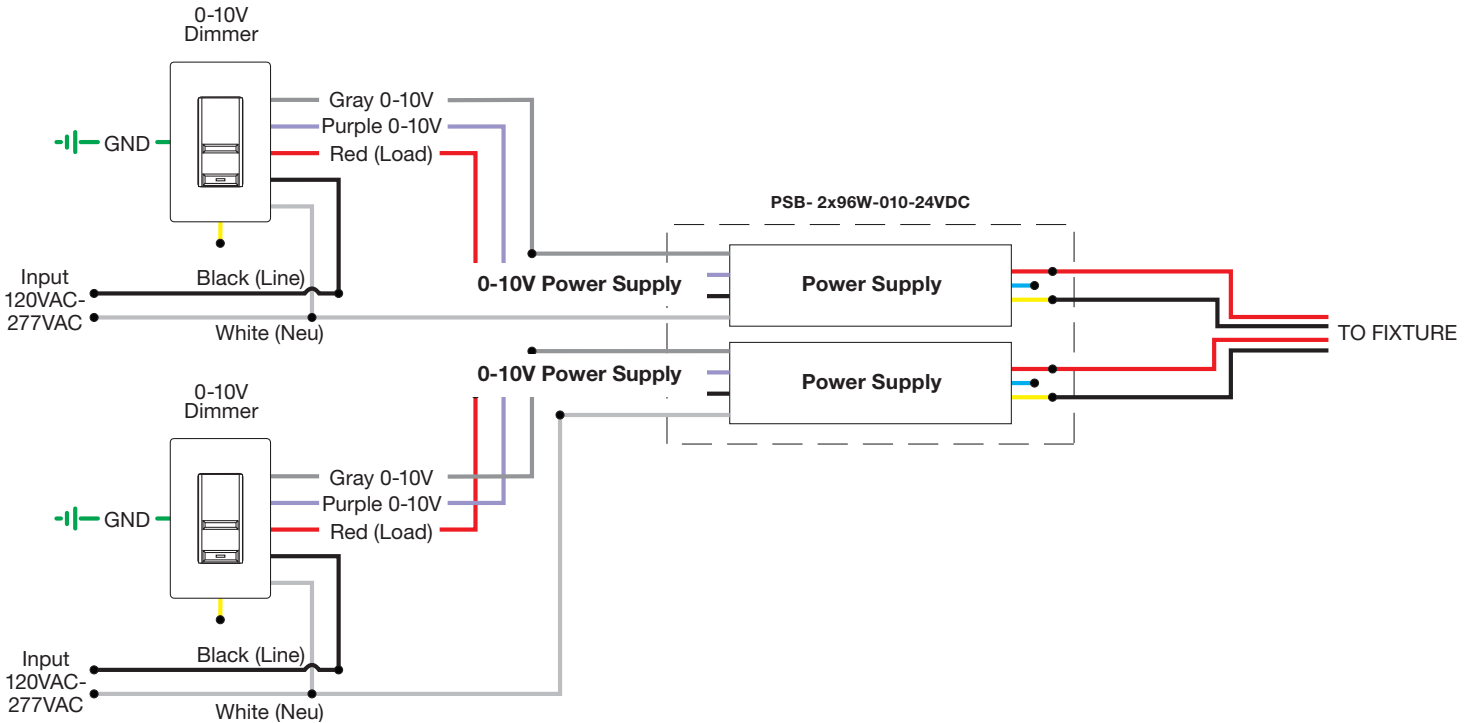

**Application:** Dual 0-10V dimming for Dynamic/Tunable White 2000K-4000K

**Dimming:** Dimmable with Dual 0-10V dimmers: Signify (Phillips) Sunrise: SR1200ZTUNV, Leviton Dimmers: LEV40050, IP710-LFZ, \*IP710-DLZ \*(Built in LED locator light), Legrand Dimmer: ADPD4FBL3P2W4, Lutron Systems: Lutron GRAFIX Eye QS Main Unit (with DRX-TVI) Radio Ra2 (with GRX-TVI)



PROJECT	FIXTURE TYPE	DATE
---------	--------------	------

LUTRON HI-LUME® PREMIER .1% ECOSYSTEM®†			
ORDERING CODES	L3D0-96W24V-U 	2-WIRE ECOSYSTEM LTEA4U1UKL-CV240 	3-WIRE ECOSYSTEM L3DA4U1UKL-CV240 
	<b>SPECIFICATIONS</b>		
MAXIMUM LOAD	96W	5W-40W	5W-40W
INPUT VOLTAGE	120-277VAC	120-277VAC	120-277VAC
OUTPUT VOLTAGE	24VDC	24VDC	24VDC
DIMENSIONS	10.5" X 5.5" X 2"	4" X 4.89" X 2.62"	4" X 4.89" X 2.62"
CLASSIFICATION	CLASS 2	CLASS 2	CLASS 2
<b>DIMMING AND CONTROLS</b>			
RADIO RA2	•	•	•
HOMEWORKS QS	•	•	•
PHPM-3F-120	•	•	•
PHPM-3F-DV	•	•	•
BCI-0-10	•	•	•

†24K - 57K color temperatures are compatible with 0-10V, ELV, and Lutron Hi-lume® Power Supplies. Warm Dim (27D, 30D) color temperatures are only compatible with ELV power supplies.

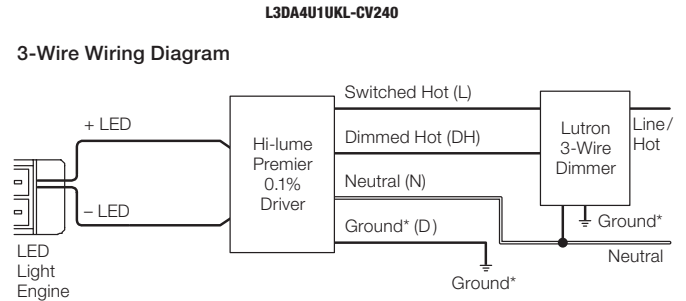
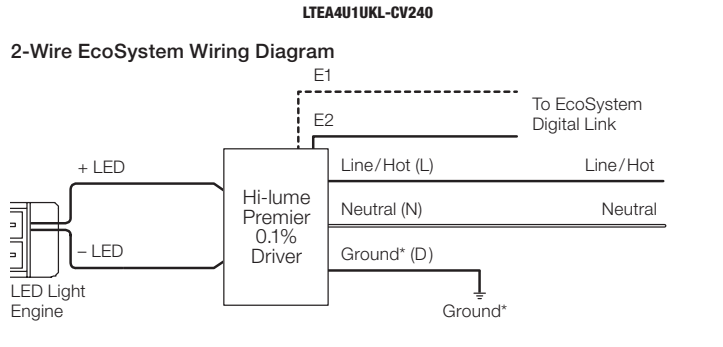

PROJECT	FIXTURE TYPE	DATE
---------	--------------	------

### TM-30-15 DATA

The data below is for SS2C, SS5C, SS7C and SS10C bare LED Soft Strips. Consistent color temperatures throughout a single strip and among multiple strips is possible through a 3 phase binning process in which each order is inspected with a color meter to ensure uniformity.

**2200K** | Rf: 83.9 | Rg: 94.9

Color Vector Graphic

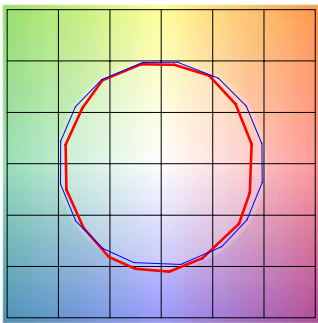

■ Test ■ Reference

		GRAPHIC SHIFTS %	
HUE BIN	Rf	CHROMA	HUE
1	77.6	-10.0%	1.8%
2	80.7	-7.5%	7.0%
3	79.5	-2.9%	8.9%
4	90.5	-3.1%	2.4%
5	93.9	-1.3%	1.9%
6	91.9	-0.9%	-0.2%
7	87.6	-6.3%	-2.7%
8	90.5	-5.4%	2.7%
9	83.8	-4.7%	6.5%
10	81.2	-2.5%	10.0%
11	83.3	3.9%	9.4%
12	86.4	5.6%	2.6%
13	86.2	4.5%	-12.4%
14	64.3	-1.0%	-21.9%
15	85.1	-4.4%	-7.5%
16	75.0	-9.9%	-12.0%

**2400K** | Rf: 84.5 | Rg: 94.4

Color Vector Graphic

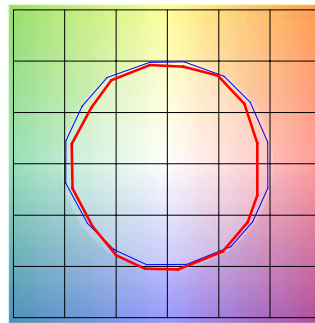

■ Test ■ Reference

		GRAPHIC SHIFTS %	
HUE BIN	Rf	CHROMA	HUE
1	81.1	-7.7%	3.0%
2	84.9	-5.7%	4.9%
3	85.3	-2.3%	6.1%
4	87.7	-5.5%	-0.5%
5	92.5	-3.9%	0.5%
6	91.1	-3.4%	0.1%
7	86.0	-7.7%	0.5%
8	87.1	-6.0%	4.3%
9	80.1	-3.9%	9.8%
10	79.0	-0.9%	11.8%
11	82.3	5.5%	10.1%
12	87.6	5.4%	-0.5%
13	84.7	3.3%	-12.0%
14	78.0	0.8%	-13.7%
15	86.9	-5.5%	-4.3%
16	78.1	-7.5%	-10.8%

**2700K** | Rf: 87.7 | Rg: 96.1

Color Vector Graphic

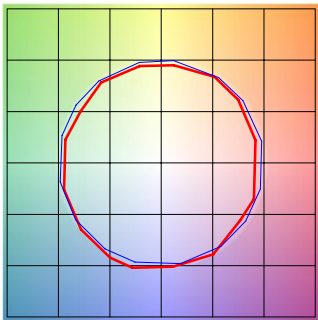

■ Test ■ Reference

		GRAPHIC SHIFTS %	
HUE BIN	Rf	CHROMA	HUE
1	86.4	-5.6%	2.3%
2	89.7	-3.3%	3.1%
3	90.5	-1.5%	3.8%
4	90.0	-4.3%	1.1%
5	92.9	-3.7%	0.2%
6	93.5	-2.5%	-0.8%
7	86.3	-7.2%	2.5%
8	90.7	-4.0%	3.2%
9	85.2	-2.4%	8.1%
10	81.7	0.9%	10.8%
11	85.4	4.5%	8.9%
12	88.7	5.7%	-1.4%
13	88.3	1.3%	-7.9%
14	85.1	2.4%	-10.4%
15	88.1	-4.8%	-2.7%
16	81.7	-4.3%	-10.9%

**3000K** | Rf: 88.1 | Rg: 99.7

Color Vector Graphic

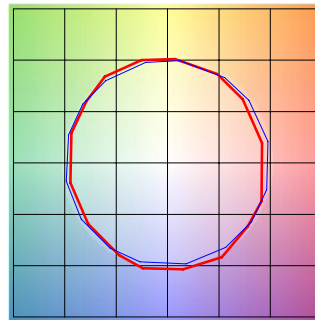

■ Test ■ Reference

		GRAPHIC SHIFTS %	
HUE BIN	Rf	CHROMA	HUE
1	87.7	-5.9%	-0.3%
2	87.9	-4.4%	4.3%
3	82.9	-1.2%	7.9%
4	89.9	0.6%	4.7%
5	92.7	3.0%	3.5%
6	92.7	3.6%	-1.7%
7	90.8	-1.3%	-4.4%
8	93.7	-2.5%	-2.2%
9	91.7	-3.7%	2.3%
10	85.5	-2.8%	7.8%
11	83.3	0.7%	11.0%
12	86.4	5.5%	3.8%
13	90.6	4.6%	-3.6%
14	85.6	5.9%	-8.4%
15	89.5	-0.6%	-5.7%
16	82.6	-2.7%	-12.0%

**3500K** | Rf: 86.1 | Rg: 95.5

Color Vector Graphic

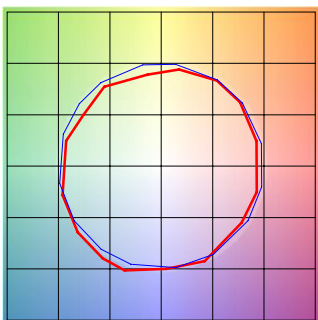

■ Test ■ Reference

		GRAPHIC SHIFTS %	
HUE BIN	Rf	CHROMA	HUE
1	86.6	-4.2%	3.4%
2	91.7	-1.4%	1.8%
3	94.9	-0.7%	0.4%
4	87.9	-4.5%	-4.1%
5	85.9	-10.3%	-2.7%
6	89.8	-5.2%	-0.4%
7	79.6	-9.5%	6.5%
8	87.6	-4.0%	5.7%
9	81.4	-0.5%	11.8%
10	78.3	3.3%	11.4%
11	85.7	6.3%	6.1%
12	86.3	7.1%	-4.6%
13	86.1	-0.7%	-9.6%
14	85.1	0.8%	-10.4%
15	83.4	-4.1%	-5.3%
16	82.5	-3.6%	-5.7%

**4000K** | Rf: 87.6 | Rg: 96.8

Color Vector Graphic

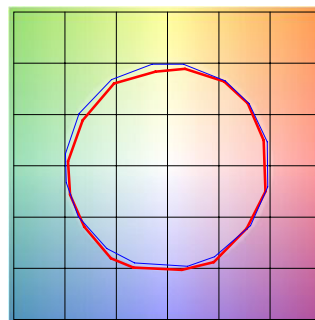

■ Test ■ Reference

		GRAPHIC SHIFTS %	
HUE BIN	Rf	CHROMA	HUE
1	89.0	-3.1%	2.1%
2	93.2	-0.9%	1.3%
3	94.3	-1.1%	0.7%
4	89.5	-4.0%	-2.3%
5	87.6	-7.8%	-1.8%
6	92.2	-4.6%	0.1%
7	87.4	-6.6%	3.6%
8	85.7	-3.8%	7.0%
9	81.5	-1.3%	12.4%
10	80.0	0.9%	11.4%
11	83.3	5.9%	8.7%
12	89.7	4.8%	-0.3%
13	88.5	2.4%	-6.3%
14	92.7	4.0%	-3.8%
15	86.1	-1.6%	-4.5%
16	85.0	-1.4%	-5.0%

PROJECT	FIXTURE TYPE	DATE
---------	--------------	------

### TM-30-15 DATA

The data below is for SS2C, SS5C, SS7C and SS10C bare LED Soft Strips. Consistent color temperatures throughout a single strip and among multiple strips is possible through a 3 phase binning process in which each order is inspected with a color meter to ensure uniformity.

**5700K** | Rf: 80.3 | Rg: 91.5

Color Vector Graphic

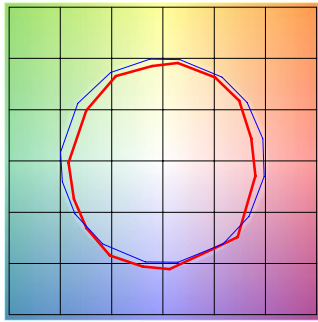

■ Test ■ Reference

		GRAPHIC SHIFTS %	
HUE BIN	Rf	CHROMA	HUE
1	73.8	-11.2%	2.6%
2	83.7	-5.5%	5.8%
3	84.2	-4.0%	5.5%
4	85.8	-3.5%	1.3%
5	85.3	-7.1%	0.6%
6	89.2	-5.8%	-2.2%
7	81.5	-10.7%	1.2%
8	75.7	-9.7%	8.5%
9	74.9	-7.8%	18.8%
10	67.8	-1.6%	18.0%
11	76.1	5.5%	12.0%
12	90.8	4.9%	-1.6%
13	83.6	5.0%	-9.5%
14	81.7	-1.2%	-10.0%
15	69.0	2.0%	-22.8%
16	83.2	-8.5%	-1.0%

**2K4K (3000K)** | Rf: 90.2 | Rg: 101.4

Color Vector Graphic

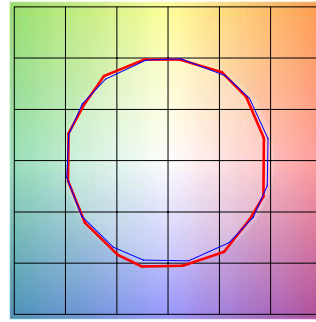

■ Test ■ Reference

		GRAPHIC SHIFTS %	
HUE BIN	Rf	CHROMA	HUE
1	90.9	-3.8%	1.3%
2	91.7	-1.9%	3.3%
3	88.7	0.7%	5.1%
4	92.4	-1.0%	0.7%
5	92.9	0.9%	1.7%
6	93.1	3.3%	-0.6%
7	91.0	-1.8%	-0.4%
8	97.0	0.2%	-1.1%
9	92.8	-0.5%	3.6%
10	88.3	1.0%	7.0%
11	87.1	3.8%	7.8%
12	87.6	6.5%	-0.3%
13	89.3	3.6%	-6.3%
14	86.1	4.5%	-9.1%
15	91.6	-1.9%	-3.1%
16	83.8	-1.5%	-11.2%

**2000K ONLY (2K4K)** | Rf: 84.3 | Rg: 96.9

Color Vector Graphic

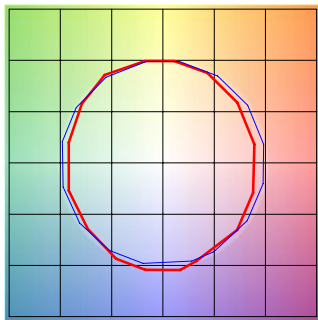

■ Test ■ Reference

		GRAPHIC SHIFTS %	
HUE BIN	Rf	CHROMA	HUE
1	80.3	-8.9%	1.7%
2	79.7	-7.0%	7.8%
3	78.9	-2.9%	10.0%
4	89.5	-0.5%	5.1%
5	94.4	0.7%	1.7%
6	92.1	2.4%	-0.3%
7	89.4	-2.4%	-5.9%
8	89.7	-6.4%	-0.2%
9	86.0	-4.9%	4.6%
10	81.8	-3.4%	9.3%
11	83.1	3.3%	9.7%
12	85.8	5.6%	3.3%
13	85.6	6.2%	-12.8%
14	61.7	-1.9%	-19.0%
15	79.7	-3.3%	-12.9%
16	78.1	-7.9%	-10.6%

**4000K ONLY (2K4K)** | Rf: 89.6 | Rg: 99.1

Color Vector Graphic

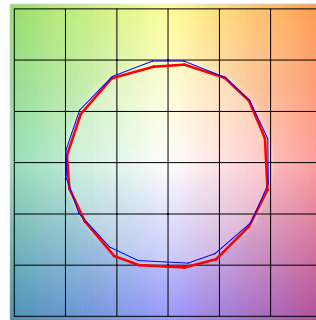

■ Test ■ Reference

		GRAPHIC SHIFTS %	
HUE BIN	Rf	CHROMA	HUE
1	91.3	-2.5%	1.0%
2	95.3	-0.5%	0.5%
3	94.3	-0.7%	1.1%
4	91.1	-3.4%	-1.1%
5	89.5	-5.6%	0.0%
6	94.6	-1.4%	1.3%
7	93.2	-3.0%	2.6%
8	91.3	-1.8%	4.6%
9	86.5	-0.9%	9.1%
10	83.3	-0.5%	9.5%
11	83.3	4.9%	9.0%
12	89.7	4.1%	1.7%
13	90.1	3.6%	-4.3%
14	93.4	5.2%	-2.1%
15	87.4	0.4%	-4.3%
16	86.6	0.4%	-6.1%

**2700D** | Rf: 89.5 | Rg: 100.8

Color Vector Graphic

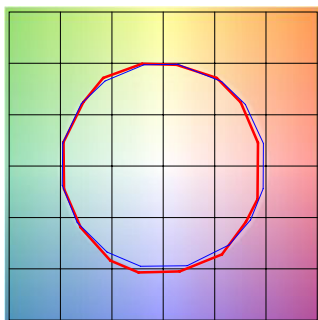

■ Test ■ Reference

		GRAPHIC SHIFTS %	
HUE BIN	Rf	CHROMA	HUE
1	88.8	-5.1%	1.4%
2	89.8	-2.7%	4.1%
3	87.2	0.3%	5.9%
4	92.3	-0.9%	1.0%
5	93.3	1.5%	1.7%
6	92.4	3.6%	-0.2%
7	92.2	-0.9%	-2.4%
8	96.7	-0.4%	-1.1%
9	92.3	-1.2%	3.7%
10	88.9	-0.0%	6.1%
11	86.4	5.1%	7.4%
12	88.2	6.3%	-0.9%
13	87.2	3.8%	-8.1%
14	84.2	3.8%	-11.0%
15	89.8	-2.6%	-4.3%
16	82.7	-3.4%	-11.1%

**3000D** | Rf: 89.8 | Rg: 101.4

Color Vector Graphic

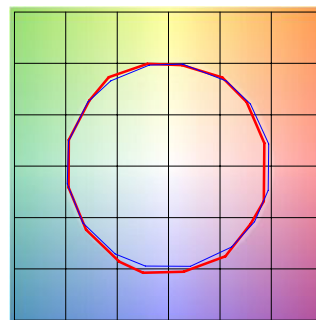

■ Test ■ Reference

		GRAPHIC SHIFTS %	
HUE BIN	Rf	CHROMA	HUE
1	90.2	-4.2%	1.5%
2	90.9	-2.0%	3.7%
3	87.9	0.8%	5.5%
4	92.1	-0.9%	0.6%
5	93.0	1.5%	1.6%
6	92.2	3.9%	-0.2%
7	92.1	-0.3%	-2.0%
8	96.7	0.0%	-1.2%
9	92.5	-0.6%	3.7%
10	88.3	1.1%	7.0%
11	87.2	4.1%	7.4%
12	87.2	6.7%	-1.0%
13	88.2	3.8%	-7.2%
14	85.3	4.3%	-9.9%
15	90.9	-2.2%	-3.6%
16	83.4	-2.2%	-11.2%