

# LIGHT CHANNEL TRIM 1.6

DESIGNED BY GREGORY KAY | ASSEMBLED IN AMERICA

REV 06.12.20



## DESCRIPTION

Light Channel Trim 1.6 provides a clean line of glare-free general illumination. The fixture is recessed within the thickness of 5/8" drywall or wood (wall, ceiling, or millwork). Available in 4 standard metal finishes for the border trim. The 24VDC linear LED system houses two rows of High CRI, commercial-grade White 85+ or 95+ CRI LED Soft Strip. The 1.6" wide Diffuser Lens projects a clean line of light without LED dots. System mounts to studs without joist modification. The system is ordered from 12" up to 120" (in increments of 3", 5", 8", or 10" after every foot). Coordinate installation with electrical and drywall contractors. Fixture includes a 5-year pro-rated warranty.

## FINISHES



Satin Black **BK**    Antique Bronze **BZ**    Chrome **CH**    Satin Nickel **SN**

## APPLICATIONS

Designed for Indoor use, damp location. Ideal applications include Vanity Lighting, General Illumination and Architectural Lighting for Offices, Hospitality, Retail and Residential environments.

## LAMP

The average LED Life is 50,000 hours.

DESCRIPTION	5WDC					
WATTS PER FOOT	5w (2 x 2.5 watts)					
COLOR TEMPERATURE	22K	27K	30K	35K	40K	57K
LUMENS PER FOOT (lm/ft)	237	288	316	362	393	418
LUMENS PER WATT (lm/w)	52	52	52	52	52	52
CRI	85+	95+	95+	85+	85+	85+

DESCRIPTION	10WDC								
WATTS PER FOOT	10w (2 x 5 watts)								
COLOR TEMPERATURE	22K	24K	27K	27D*	30K	30D*	35K	40K	57K
LUMENS PER FOOT (lm/ft)	468		571	775	624	847	714	777	827
LUMENS PER WATT (lm/w)	71	71	71	71	71	71	71	71	71
CRI	85+	90+	95+	92+	95+	92+	85+	85+	85+

## REMOTE POWER SUPPLIES\*, DIMMERS & CONTROLS (SOLD SEPARATELY)

- Universal Power Supplies (UNI)
- Lutron Hi-Lume®
- Electronic Low Voltage Dimming (ELV)
- 0-10 Volt Dimming (0-10V)

\*In-Wall Mounting Kits available for select power supplies

† With N-Lite Dimming Do Not use ELV power supplies, use only 0-10 volt or Uni drivers power supplies

## APPROVALS

Damp Location, ETL Listed

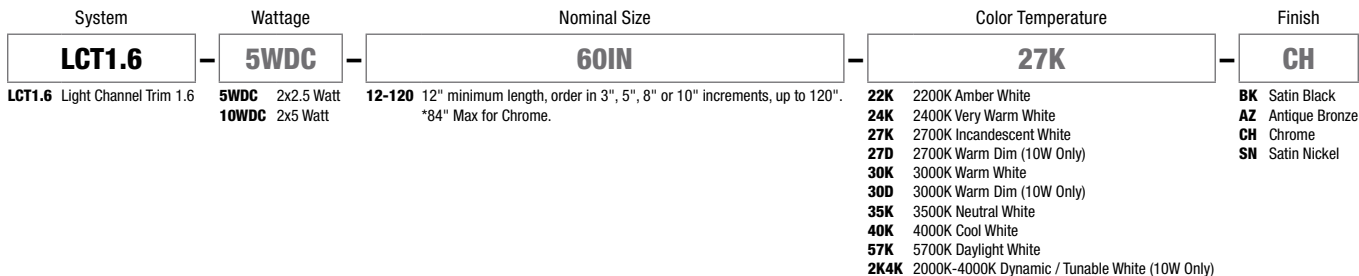

PROJECT	FIXTURE TYPE	DATE
---------	--------------	------

# LIGHT CHANNEL TRIM 1.6

REV 06.12.20

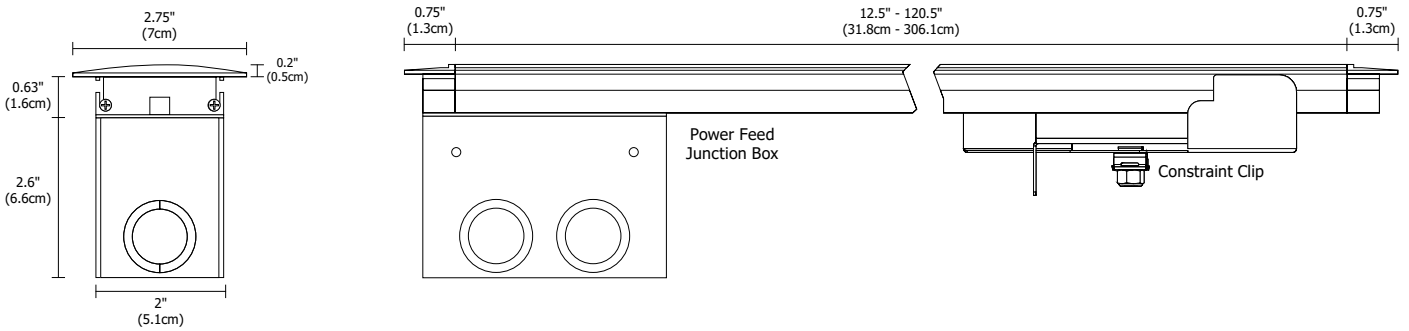

**APPLICATION** 0-10V dimming for Light Channel Trim 1.6  
**POWER SUPPLY** Class 2, 120-277VAC input | PSB-96W-010-24VDC: 24VDC 96W output | PSB-2x96W-010-24VDC: 24VDC 192W output  
**DIMMING** Dimmable with 0-10V dimmer using Power Supply above: Philips Sunrise SR1200ZTUNV

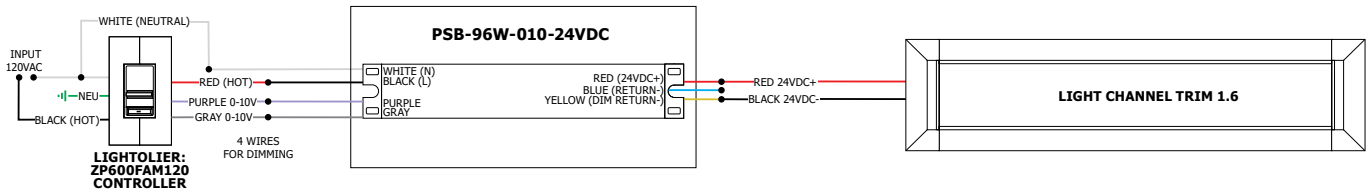

96W, 24VDC LOW VOLTAGE WIRE SIZE CHART: 3% VOLTAGE DROP

WIRE LENGTH (FT)	UP TO 33FT	34FT-52FT	53FT-86FT	87FT-130FT
WIRE SIZE	14 AWG	12 AWG	10 AWG	8 AWG
VOLTAGE AT END OF WIRE	23.28VDC	23.29VDC	23.28VDC	23.28VDC

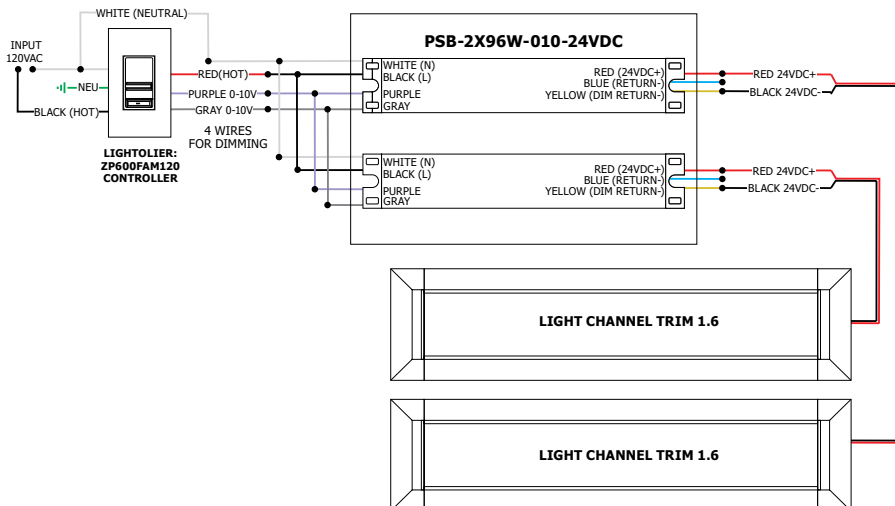

5 WATTS - ACTUAL WATTAGE PER FOOT		10 WATTS - ACTUAL WATTAGE PER FOOT	
LENGTH IN FEET	WATTS	LENGTH IN FEET	WATTS
1	5	1	10
2	10	2	20
3	15	3	30
4	20	4	40
5	25	5	50
6	30	6	60
7	35	7	70
8	40	8	80
9	45	9	90
10	50	10	100

PROJECT		FIXTURE TYPE		DATE	
---------	--	--------------	--	------	--

# LIGHT CHANNEL TRIM 1.6

REV 06.12.20

**ACCESSORIES** Order based on lighting design or as replacement parts

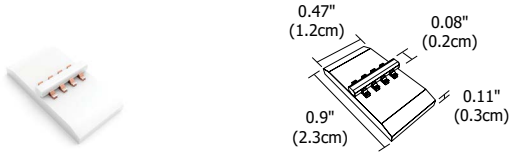

### SOFT STRIP SOLDERLESS SNAP & LIGHT STRAIGHT JOINER

Joins two sections of LED Soft Strip in the Channel. Used when replacing a section of LED Soft Strip.

System	Product
<b>CH</b>	<b>SLC</b>
CH Channel	SLC Snap & Light Straight Joiner

## LIGHT CHANNEL TRIM 1.6 VERTICAL INSTALLATION OPTION

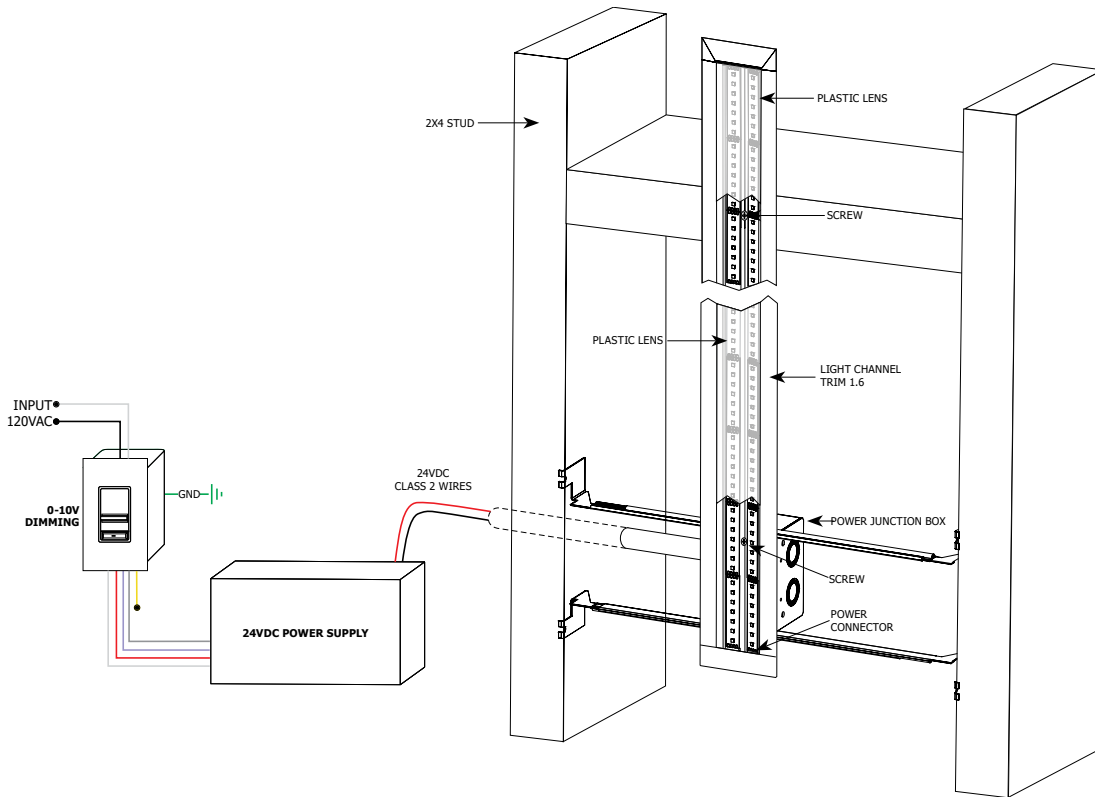

## LIGHT CHANNEL TRIM 1.6 HORIZONTAL INSTALLATION OPTION

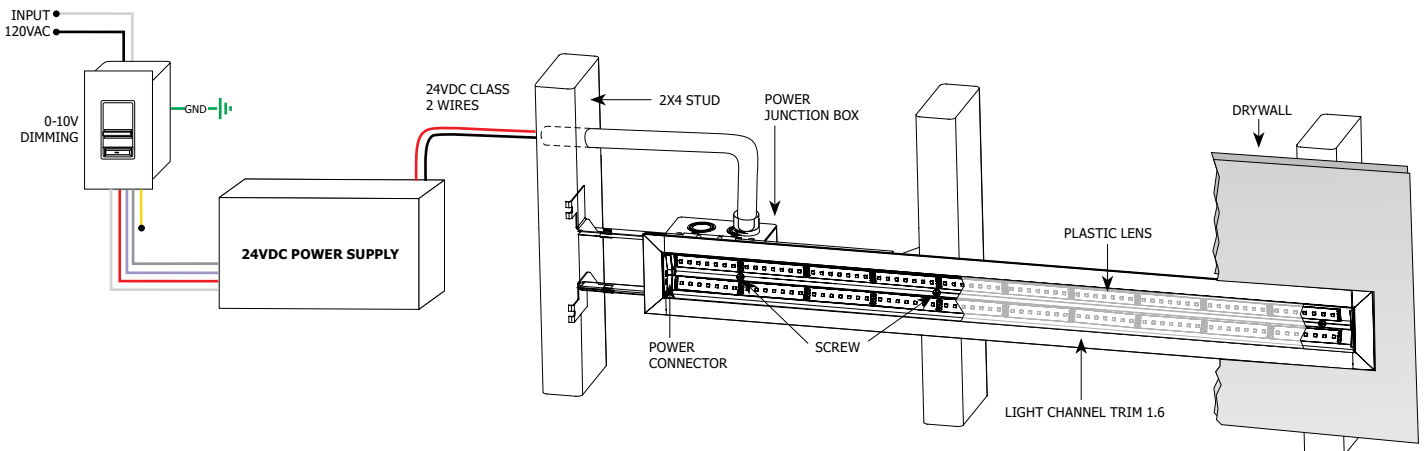

PROJECT	FIXTURE TYPE	DATE
---------	--------------	------

# LIGHT CHANNEL TRIM 1.6

REV 06.12.20

## LENGTH CHART Actual lengths for Light Channel Trim 1.6

22K, 24K, 27K, 30K, 35K, 40K, 57K, 2K4K & RGB							
Ordering Code (Nominal Size)	Illuminated Length (Inches)	Overall Bottom Recessed Length (Inches)	Overall Top Exposed Length Including End Caps (Inches)	Ordering Code (Nominal Size)	Illuminated Length (Inches)	Overall Bottom Recessed Length (Inches)	Overall Top Exposed Length Including End Caps (Inches)
12IN	12.5	13.5	14.25	68IN	67.7	68.7	69.45
15IN	14.9	15.9	16.65	70IN	70.1	71.1	71.85
17IN	17.3	18.3	19.05	72IN	72.5	73.5	74.25
20IN	19.7	20.7	21.45	75IN	74.9	75.9	76.65
22IN	22.1	23.1	23.85	77IN	77.3	78.3	79.05
24IN	24.5	25.5	26.25	80IN	79.7	80.7	81.45
27IN	26.9	27.9	28.65	82IN	82.1	83.1	83.85
29IN	29.3	30.3	31.05	84IN	84.5	85.5	86.25
32IN	31.7	32.7	33.45	87IN	86.9	87.9	88.65
34IN	34.1	35.1	35.85	89IN	89.3	90.3	91.05
36IN	36.5	37.5	38.25	92IN	91.7	92.7	93.45
39IN	38.9	39.9	40.65	94IN	94.1	95.1	95.85
41IN	41.3	42.3	43.05	96IN	96.5	97.5	98.25
44IN	43.7	44.7	45.45	99IN	98.9	99.9	100.65
46IN	46.1	47.1	47.85	101IN	101.3	102.3	103.05
48IN	48.5	49.5	50.25	104IN	103.7	104.7	105.45
51IN	50.9	51.9	52.65	106IN	106.1	107.1	107.85
53IN	53.3	54.3	55.05	108IN	108.5	109.5	110.25
56IN	55.7	56.7	57.45	111IN	110.9	111.9	112.65
58IN	58.1	59.1	59.85	113IN	113.3	114.3	115.05
60IN	60.5	61.5	62.25	116IN	115.7	116.7	117.45
63IN	62.9	63.9	64.65	118IN	118.1	119.1	119.85
65IN	65.3	66.3	67.05	120IN	120.5	121.5	122.25

27D & 30D WARM DIM							
Ordering Code (Nominal Size)	Illuminated Length (Inches)	Overall Bottom Recessed Length (Inches)	Overall Top Exposed Length Including End Caps (Inches)	Ordering Code (Nominal Size)	Illuminated Length (Inches)	Overall Bottom Recessed Length (Inches)	Overall Top Exposed Length Including End Caps (Inches)
12IN	12.5	13.5	14.25	69IN	69.5	70.5	71.25
15IN	15.5	16.5	17.25	72IN	72.5	73.5	74.25
18IN	18.5	19.5	20.25	75IN	75.5	76.5	77.25
21IN	21.5	22.5	23.25	78IN	78.5	79.5	80.25
24IN	24.5	25.5	26.25	81IN	81.5	82.5	83.25
27IN	27.5	28.5	29.25	84IN	84.5	85.5	86.25
30IN	30.5	31.5	32.25	87IN	87.5	88.5	89.25
33IN	33.5	34.5	35.25	90IN	90.5	91.5	92.25
36IN	36.5	37.5	38.25	93IN	93.5	94.5	95.25
39IN	39.5	40.5	41.25	96IN	96.5	97.5	98.25
42IN	42.5	43.5	44.25	99IN	99.5	100.5	101.25
45IN	45.5	46.5	47.25	102IN	102.5	103.5	104.25
48IN	48.5	49.5	50.25	105IN	105.5	106.5	107.25
51IN	51.5	52.5	53.25	108IN	108.5	109.5	110.25
54IN	54.5	55.5	56.25	111IN	111.5	112.5	113.25
57IN	57.5	58.5	59.25	114IN	114.5	115.5	116.25
60IN	60.5	61.5	62.25	117IN	117.5	118.5	119.25
63IN	63.5	64.5	65.25	120IN	120.5	121.5	122.25
66IN	66.5	67.5	68.25				

PROJECT		FIXTURE TYPE		DATE	
---------	--	--------------	--	------	--



**IN WALL MOUNTING OPTIONS**

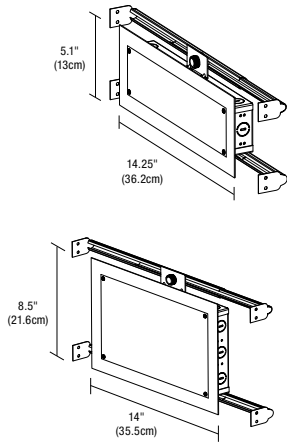

**In-Wall Mounting Kit:** Includes power supply, box cover and stud hangers for installing Junction Box in wall. Select "IW" in the options section of compatible power supply ordering codes if an In-Wall Mounting Kit is needed.

**Ordering Codes 5.1 x 14.25 inch:** PSB-40W-UNI-24VDC-IW  
PSB-60W-UNI-24VDC-IW  
PSB-96W-UNI-24VDC-IW

**Ordering Codes 8.5 x 14.25 inch:** PSB-2X40W-UNI-24VDC-IW  
PSB-2X60W-UNI-24VDC-IW  
PSB-2X96W-UNI-24VDC-IW

**WIRING DIAGRAMS UNIVERSAL POWER SUPPLY**

**Application:** Triac dimming for two power supplies, use for Static White, Dynamic/Tunable White 2000K-4000K

**Dimming:** Dimmable with Triac dimmer: Lutron: Skylark S2-L

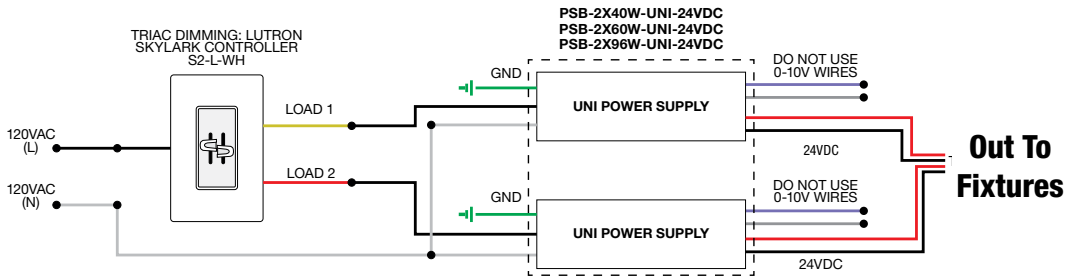

**Application:** ELV dimming for Static White and Warm Dim

**Dimming:** Dimmable with ELV dimmer: Legrand, Adorne ADTP703TU; Lutron: Diva DVELV-300P, Skylark SELV-300P, Maestro MAELV-600 and Radio Ra 2

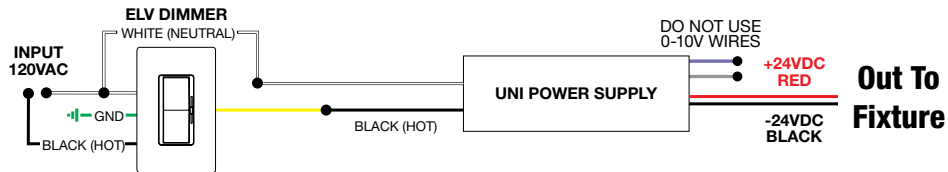

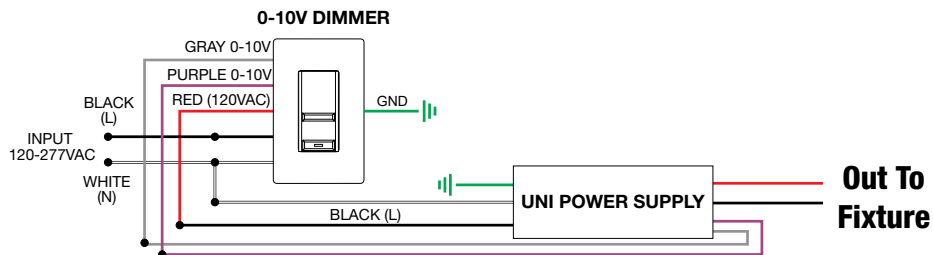

**Application:** 0-10V dimming for Static White

**Dimming:** Dimmable with 0-10V dimmer: Philips Sunrise: SR1200ZTUNV; Lutron Diva: DVTV-WH, DVSTV-WH; Lutron Nova T: NTSTV-DV-XX; Lutron Grafix EYE QS: QSGRJ-XP; Lutron Radio Ra2: RRD-10ND; Leviton: LEV40050; Leviton IP710-LFZ; Legrand: ADPD4FBL3P2W4



PROJECT		FIXTURE TYPE		DATE	
---------	--	--------------	--	------	--

<b>LUTRON HI-LUME® PREMIER .1% ECOSYSTEM®†</b>			
<b>ORDERING CODES</b>	<b>L3D0-96W24V-U</b>	<b>2-WIRE ECOSYSTEM LTEA4U1UKL-CV240</b>	<b>3-WIRE ECOSYSTEM L3DA4U1UKL-CV240</b>
			
<b>SPECIFICATIONS</b>			
<b>MAXIMUM LOAD</b>	96W	5W-40W	5W-40W
<b>INPUT VOLTAGE</b>	120-277VAC	120-277VAC	120-277VAC
<b>OUTPUT VOLTAGE</b>	24VDC	24VDC	24VDC
<b>DIMENSIONS</b>	10.5" X 5.5" X 2"	4" X 4.89" X 2.62"	4" X 4.89" X 2.62"
<b>CLASSIFICATION</b>	CLASS 2	CLASS 2	CLASS 2
<b>DIMMING AND CONTROLS</b>			
<b>RADIO RA2</b>	•	•	•
<b>HOMEWORKS QS</b>	•	•	•
<b>PHPM-3F-120</b>	•	•	•
<b>PHPM-3F-DV</b>	•	•	•
<b>BCI-0-10</b>	•	•	•

†24K - 57K color temperatures are compatible with 0-10V, ELV, and Lutron Hi-lume® Power Supplies. Warm Dim (27D, 30D) color temperatures are only compatible with ELV power supplies.

**2-Wire EcoSystem Wiring Diagram**

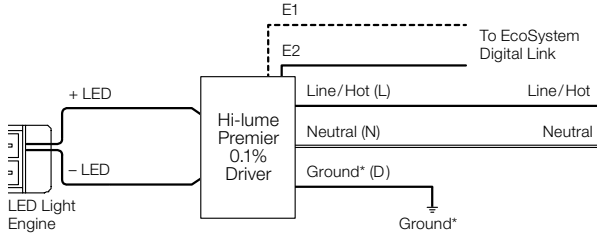

**LTEA4U1UKL-CV240**

**3-Wire Wiring Diagram**

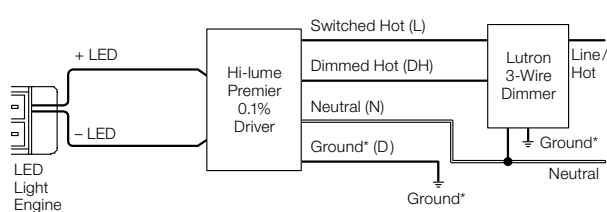

**L3DA4U1UKL-CV240**

PROJECT	FIXTURE TYPE	DATE
---------	--------------	------

LUTRON HI-LUME® PREMIER .1% ECOSYSTEM®†			
ORDERING CODES	L3D0-96W24V-U	2-WIRE ECOSYSTEM LTEA4U1UKL-CV240	3-WIRE ECOSYSTEM L3DA4U1UKL-CV240
<b>SPECIFICATIONS</b>			
<b>MAXIMUM LOAD</b>	96W	5W-40W	5W-40W
<b>INPUT VOLTAGE</b>	120-277VAC	120-277VAC	120-277VAC
<b>OUTPUT VOLTAGE</b>	24VDC	24VDC	24VDC
<b>DIMENSIONS</b>	10.5" X 5.5" X 2"	4" X 4.89" X 2.62"	4" X 4.89" X 2.62"
<b>CLASSIFICATION</b>	CLASS 2	CLASS 2	CLASS 2
<b>DIMMING AND CONTROLS</b>			
<b>RADIO RA2</b>	•	•	•
<b>HOMEWORKS QS</b>	•	•	•
<b>PHPM-3F-120</b>	•	•	•
<b>PHPM-3F-DV</b>	•	•	•
<b>BCI-0-10</b>	•	•	•

†24K - 57K color temperatures are compatible with 0-10V, ELV, and Lutron Hi-Lume® Power Supplies. Warm Dim (27D, 30D) color temperatures are only compatible with ELV power supplies.

\*Tunable White (2K4K) Color Temperature is compatible with 0-10V, ELV, DMX, and Lutron Hi-Lume® Power Supplies. Dynamic Color (RGB, RGB+W) and Static Color (Amber, Blue, Green, or Red) are compatible with DMX Power Supplies.

\*\*Tunable White (2K4K) uses one or two power supplies, dependent on the controller or dimmer(s) used.

Lutron Hi-Lume® can be used in both single or dual power formats, dependent on the controller or dimmer(s). Specify amount of Power Supplies based on this.

### WIRING DIAGRAM: DMX Control with Lutron Grafik Eye Control Unit

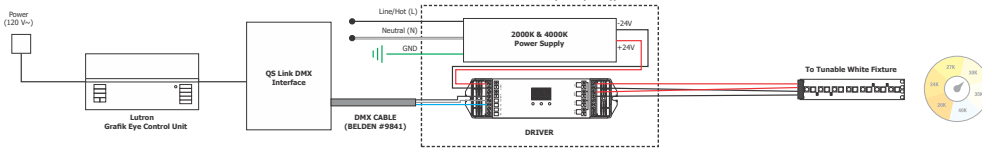

### WIRING DIAGRAM: Line Voltage Dimming with Lutron Grafik Eye Control Unit

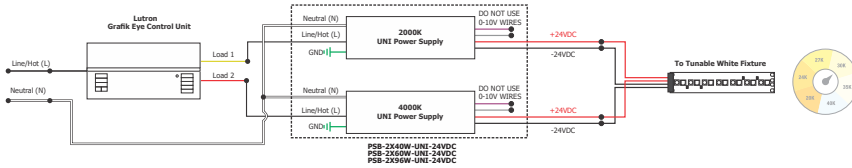

### WIRING DIAGRAM: 0-10V Dimming with Lutron Grafik Eye Control Unit or Wall box controller

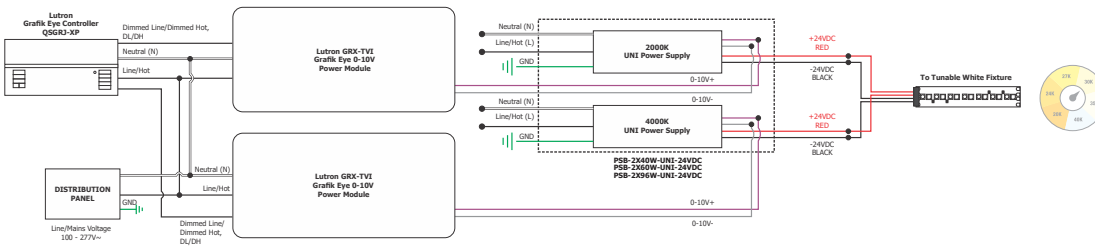

### WIRING DIAGRAM: 2-Wire EcoSystem Panel

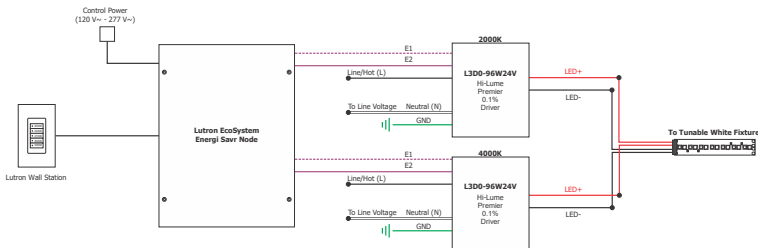

### WIRING DIAGRAM: 3-Wire EcoSystem Wall Box

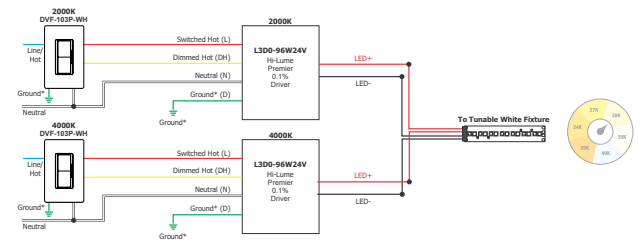

PROJECT	FIXTURE TYPE	DATE
---------	--------------	------



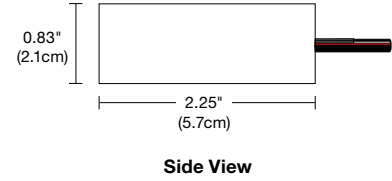
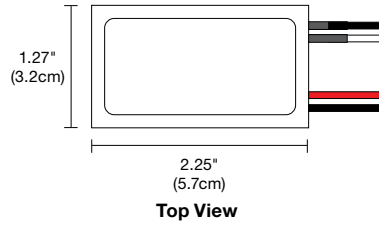
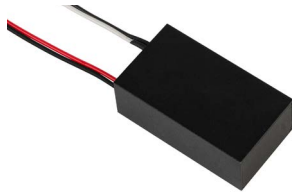

**DESCRIPTION**

Compact, lightweight remote electronic 60W/24V LED Power Supply\* converts standard 120VAC voltage to 24VDC and features built-in short-circuit protection. The low voltage output may be dimmed using an electronic low voltage dimmer. The Power Supply is certified to be used inside a standard Junction Box enclosure. Power Supply features short circuit and overload protection. Indoor applications only.

*\*Electrical Panels using Siemens/Murray AFCI breakers are not compatible with this ELV transformer. Use 0-10 Volt power supplies with this breaker.*

**POWER INPUT**

120 volts AC, 60Hz

**POWER OUTPUT**

Class 2; 24 volts DC 2.5A 60 watt maximum

**DIMENSIONS**

2.25" x 1.25" x 0.83"

**DIMMER TYPE**

Electronic Low Voltage Dimmer Lutron: Diva #DVELV-300P; Skylark #SELV-300P; Maestro #MAELV-600

**APPLICATIONS**

Indoor\*

To avoid overheating the power supply, install it in a ventilated remote location where air flows. Maintain proper spacing among power supplies when multiple power supplies are installed in the same remote location.

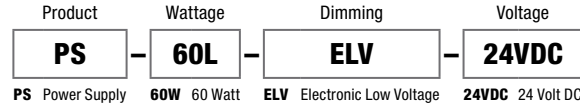
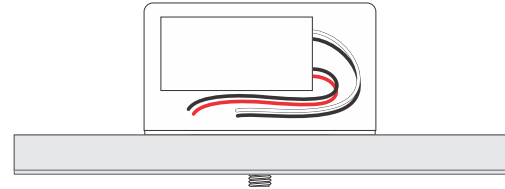

**SAMPLE WIRING DIAGRAMS 24VDC ELV**

**Application:** ELV dimming for Static White

**Dimming:** Dimmable with ELV dimmer: Legrand, Adorne ADTP703TU; Lutron: Diva DVELV-300P, Skylark SELV-300P, Maestro MAELV-600 and Radio Ra 2

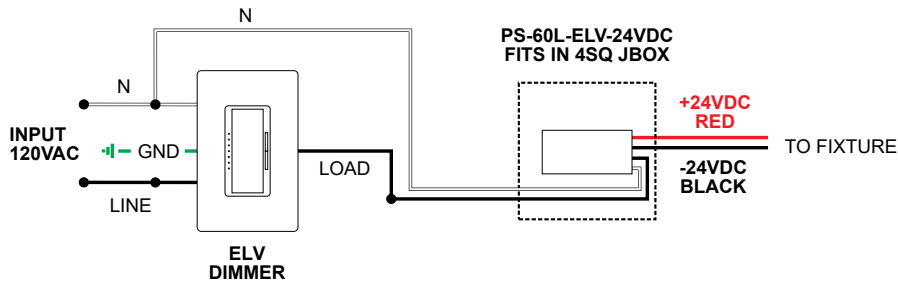

**Application:** Dual ELV dimming for Dynamic/Tunable White 2000K-4000K

**Dimming:** Dimmable with ELV dimmer: Legrand, Adorne ADTP703TU; Lutron: Diva DVELV-300P, Skylark SELV-300P, Maestro MAELV-600 and Radio Ra 2

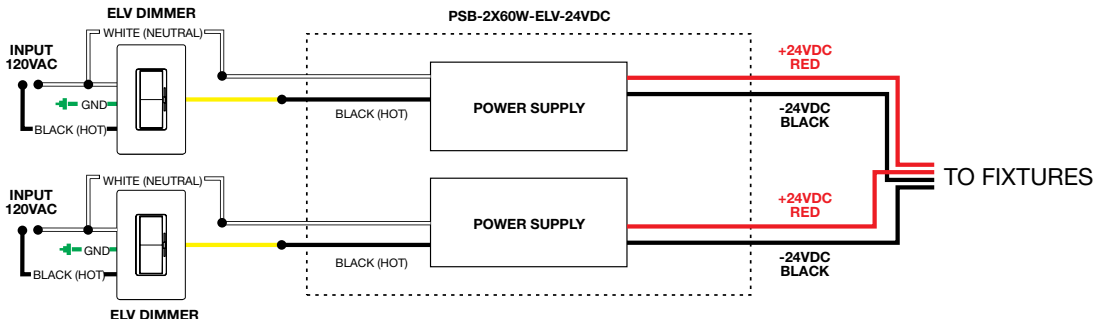

PROJECT	FIXTURE TYPE	DATE
---------	--------------	------

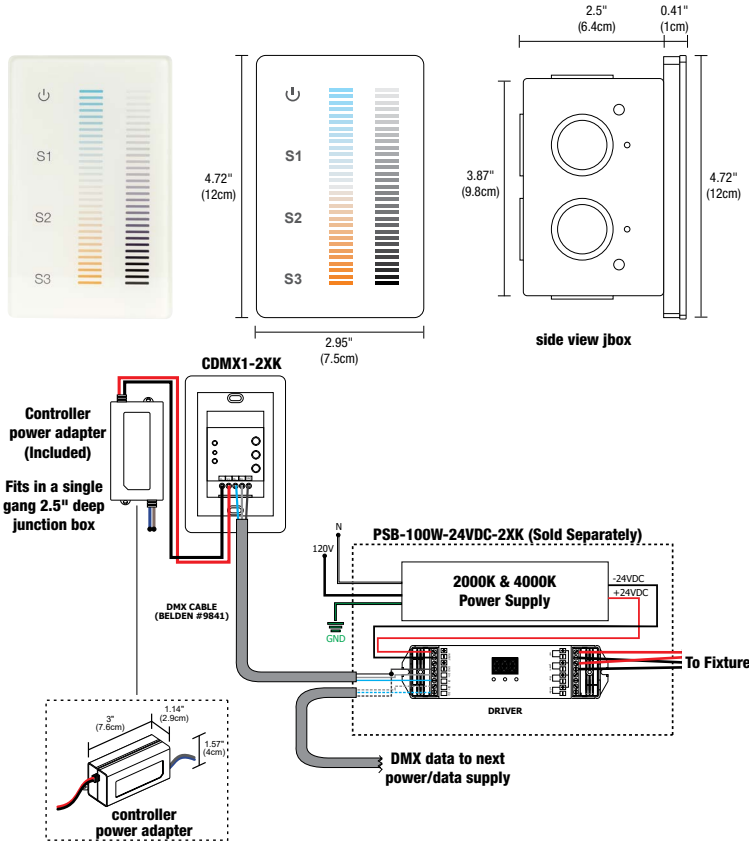

**DESCRIPTION:**

The Dynamic/Tunable White (**2K4K**) Touch Controller offers fast and accurate Color Temperature adjustment and the ability to regulate the Brightness Independently. The modern Glass faceplate features illuminated indicators, and a back-lit night light that softly illuminates the controller when powered off. Designed for Dynamic/Tunable White, and dual-color LED installations within a single zone. The two Vertical Touch sliders are precise and sensitive, allowing you to fine-tune your perfect Color Temperature at any point between **2000K (Sunset) to 4000K (Cool White)** while selecting over **250 levels** of Brightness in a smooth, uninterrupted transition. Create Thousands of Dynamic White Color Combinations while maintaining even Brightness and overall saturation. Easily save three pre-set scenes for different times of the day. Support health, performance, and general well-being using Human-Centric lighting by fine-tuning the biological effects that light has on the circadian cycle using the latest in LED technology. Includes a power adapter that fits behind the controller within a standard junction box and fits inside a standard single-gang receptacle (not for use in a multi-gang box). Use with an insulated, 24 AWG stranded, tinned copper wire (Belden #9841). Power Supplies are Sold Separately. Includes a 5 year pro-rated warranty.

**APPLICATIONS:**

Indoor

**OUTPUT SIGNAL:**

USITT DMX 512 (1990)

**INSTALLATION:**

Fits in a single gang 2.5 inch deep junction box. Not compatible with multi-gang boxes.

**LABELS:**

ROHS, FCC, Damp Location, ETL/UL

**POWER INPUT:**

120-240VAC

Product	Type	Finish
<b>CDMX1</b>	<b>2XK</b>	<b>WH</b>
CDMX1 DMX Single Zone Touch Controller	2XK 2 X Kelvin	WH White

**DYNAMIC COLOR CHANGING (DMX) POWER SUPPLIES & RECOMMENDED CONTROLLERS\***

ORDERING CODE	PSB-100W-24VDC-2XK	PSB-2X100W-24VDC-2XK	PSB-3X100W-24VDC-2XK	PSB-4X100W-24VDC-2XK
<b>MAXIMUM LOAD OF LED STRIP LENGTH</b>	100W 5 WATTS - 20FT MAX. 10 WATTS - 10FT MAX.	2X100W 5 WATTS 2 X 20FT MAX. 10 WATTS - 2 X 10FT MAX.	3X100W 5 WATTS 3 X 20FT MAX. 10 WATTS - 3 X 10FT MAX.	4X100W 5 WATTS 4 X 20FT MAX. 10 WATTS - 4 X 10FT MAX.
<b>INPUT VOLTAGE</b>	120-277VAC	120-277VAC	120-277VAC	120-277VAC
<b>OUTPUT VOLTAGE</b>	24VDC	24VDC	24VDC	24VDC
<b>DIMENSIONS</b>	12.4" X 6.48" X 2.18"	14" X 10" X 3"	17" X 10" X 3"	17" X 10" X 3"
<b>CLASSIFICATION</b>	CLASS 2	CLASS 2	CLASS 2	CLASS 2
<b>IN-WALL MOUNTING</b>	PSB-100W-24VDC-2XK-IW	NA	NA	NA
<b>DMX DYNAMIC/TUNABLE WHITE DIMMING &amp; CONTROLS</b>				
<b>TUNABLE WHITE TOUCH CONTROLLER (CDMX1-2XK)</b>	•	•	•	•

- Flicker free dimming
- Aluminum casing for optimal heat dissipation
- Isolated output power per NEC and UL safety requirements
- UL & ETL recognized/ listed, meets UL 8750, 1310 requirements

- Auto-reset; short circuit, overload and thermal protection
- Class 2 power supply
- Efficient, High power factor > 0.90

**IN WALL MOUNTING OPTIONS**

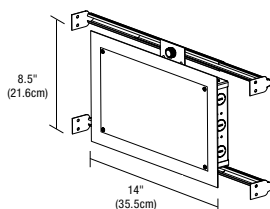

**8.5 x 14 inch In-Wall Mounting Kit:** Includes power supply, box cover and stud hangers for installing Junction Box in wall. Select "IW" in the options section of compatible power supply ordering codes if an In-Wall Mounting Kit is needed.

**Ordering Codes:** PSB-100W-24VDC-2XK-IW

PROJECT		FIXTURE TYPE		DATE	
---------	--	--------------	--	------	--

# LIGHT CHANNEL TRIM TM30 DATA

**TM-30-15 DATA:** The data below is for SS5C and SS10C bare LED Soft Strips. Consistent color temperatures throughout a single strip and among multiple strips is possible through a 3 phase binning process in which each order is inspected with a color meter to ensure uniformity.

**2200K** | Rf: 83.9 | Rg: 94.9

Color Vector Graphic

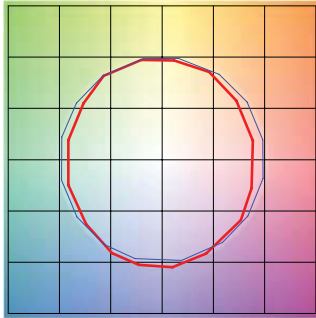

■ Test ■ Reference

HUE BIN	Rf	GRAPHIC SHIFTS %	
		CHROMA	HUE
1	78.8	-9.5%	1.3%
2	80.7	-7.8%	6.7%
3	78.2	-3.3%	9.4%
4	89.7	-2.8%	3.6%
5	93.2	-0.8%	2.6%
6	93.0	-0.6%	-0.7%
7	87.7	-5.9%	-3.5%
8	89.2	-6.8%	1.9%
9	83.4	-5.6%	6.0%
10	79.3	-3.7%	10.8%
11	81.4	2.9%	11.1%
12	84.9	5.3%	4.9%
13	88.1	4.9%	-10.1%
14	68.1	0.1%	-19.5%
15	86.0	-3.3%	-7.3%
16	76.4	-8.9%	-11.7%

**2400K** | Rf: 91.2 | Rg: 96.8

Color Vector Graphic

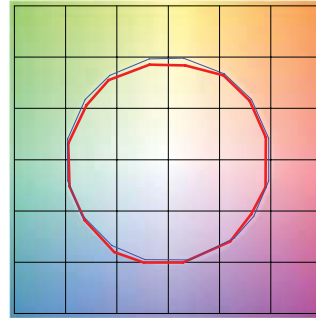

■ Test ■ Reference

HUE BIN	Rf	GRAPHIC SHIFTS %	
		CHROMA	HUE
1	92.0	-2.4%	1.5%
2	94.7	-2.1%	0.0%
3	95.4	-1.9%	-0.1%
4	88.7	-6.7%	-3.1%
5	92.8	-5.6%	1.0%
6	92.7	-3.4%	3.4%
7	89.9	-4.3%	4.1%
8	92.4	-1.4%	4.4%
9	89.0	-0.6%	5.8%
10	88.9	0.4%	6.2%
11	89.7	4.0%	5.4%
12	92.6	3.0%	-0.7%
13	90.9	1.1%	-7.0%
14	89.9	0.5%	-5.8%
15	92.1	-3.2%	0.1%
16	88.9	-1.7%	-6.3%

**2700K** | Rf: 87.7 | Rg: 96.1

Color Vector Graphic

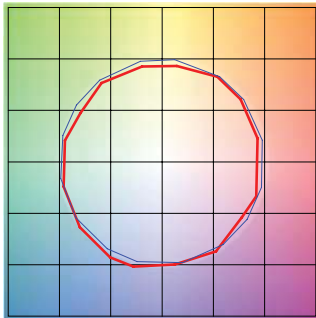

■ Test ■ Reference

HUE BIN	Rf	GRAPHIC SHIFTS %	
		CHROMA	HUE
1	88.0	-4.3%	2.6%
2	91.6	-2.4%	2.0%
3	93.7	-1.4%	1.9%
4	88.9	-5.6%	-3.1%
5	92.3	-5.5%	-0.5%
6	92.9	-3.5%	0.1%
7	84.5	-7.5%	4.6%
8	90.8	-3.0%	4.4%
9	84.5	-1.3%	8.3%
10	83.9	2.0%	9.8%
11	87.2	5.3%	7.1%
12	89.2	5.4%	-2.6%
13	88.7	0.3%	-7.8%
14	86.8	1.7%	-9.3%
15	87.6	-5.4%	-1.3%
16	83.6	-3.3%	-9.5%

**3000K** | Rf: 88.1 | Rg: 99.7

Color Vector Graphic

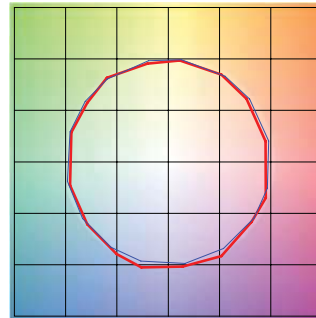

■ Test ■ Reference

HUE BIN	Rf	GRAPHIC SHIFTS %	
		CHROMA	HUE
1	92.5	-3.1%	0.3%
2	93.3	-2.3%	1.9%
3	90.9	-0.8%	3.9%
4	94.3	-1.1%	1.4%
5	92.5	-2.6%	1.5%
6	96.4	1.2%	-0.3%
7	92.6	-2.5%	-0.0%
8	96.9	-1.4%	0.2%
9	92.3	-1.8%	4.3%
10	86.6	-0.7%	7.0%
11	86.5	2.4%	8.2%
12	89.8	5.9%	1.7%
13	93.9	2.6%	-2.7%
14	89.4	5.1%	-5.8%
15	90.1	-0.1%	-4.7%
16	86.5	0.3%	-9.7%

**3500K** | Rf: 86.1 | Rg: 95.5

Color Vector Graphic

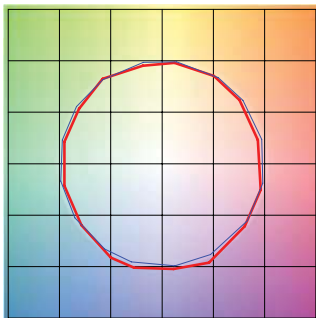

■ Test ■ Reference

HUE BIN	Rf	GRAPHIC SHIFTS %	
		CHROMA	HUE
1	90.8	-3.8%	0.3%
2	92.3	-2.8%	2.1%
3	89.7	-1.0%	4.3%
4	92.6	-1.4%	1.7%
5	91.8	-3.1%	1.3%
6	96.2	0.8%	-0.4%
7	92.9	-3.2%	0.2%
8	94.3	-2.5%	1.5%
9	90.4	-2.5%	5.2%
10	84.3	-1.4%	9.5%
11	83.1	3.5%	9.8%
12	88.2	4.8%	3.4%
13	94.0	2.7%	-2.0%
14	88.7	5.9%	-5.8%
15	88.7	0.7%	-5.9%
16	86.8	-0.7%	-6.7%

**4000K** | Rf: 87.6 | Rg: 96.8

Color Vector Graphic

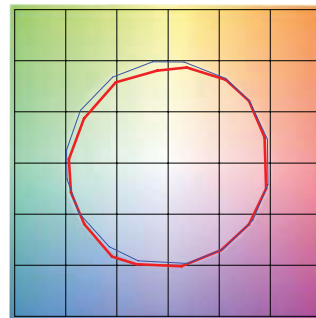

■ Test ■ Reference

HUE BIN	Rf	GRAPHIC SHIFTS %	
		CHROMA	HUE
1	88.9	-2.4%	2.5%
2	93.3	-0.4%	0.8%
3	94.8	-1.0%	-0.6%
4	87.9	-4.9%	-3.6%
5	85.3	-9.4%	-2.6%
6	90.2	-6.0%	0.2%
7	85.3	-7.6%	4.6%
8	83.7	-4.1%	8.2%
9	79.5	-1.1%	13.8%
10	78.6	1.5%	12.1%
11	83.5	6.4%	7.8%
12	90.9	3.6%	-1.1%
13	88.3	1.7%	-6.3%
14	91.9	-0.4%	-2.2%
15	84.5	-0.9%	-5.5%
16	84.7	-1.1%	-4.4%

PROJECT	FIXTURE TYPE	DATE
---------	--------------	------

# LIGHT CHANNEL TRIM TM30 DATA

**TM-30-15 DATA:** The data below is for SS5C and SS10C bare LED Soft Strips. Consistent color temperatures throughout a single strip and among multiple strips is possible through a 3 phase binning process in which each order is inspected with a color meter to ensure uniformity.

**5700K** | Rf: 80.3 | Rg: 91.5

Color Vector Graphic

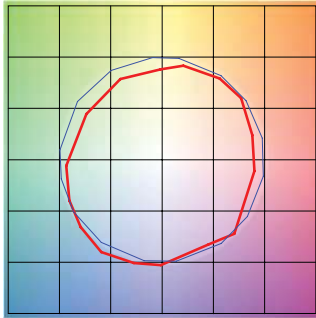

■ Test ■ Reference

HUE BIN	Rf	GRAPHIC SHIFTS %	
		CHROMA	HUE
1	75.4	-8.9%	4.7%
2	87.5	-2.6%	4.6%
3	90.7	-3.0%	-0.5%
4	83.2	-6.0%	-5.7%
5	76.2	-12.9%	-5.3%
6	81.4	-11.9%	-2.6%
7	74.8	-14.0%	5.1%
8	69.0	-9.0%	14.1%
9	72.6	-3.6%	22.2%
10	71.4	2.7%	16.1%
11	81.3	7.9%	5.3%
12	83.6	4.1%	-9.4%
13	78.4	0.7%	-15.3%
14	77.7	-6.2%	-11.0%
15	68.8	-1.3%	-21.2%
16	80.8	-9.6%	3.3%

**2700D** | Rf: 89.5 | Rg: 100.8

Color Vector Graphic

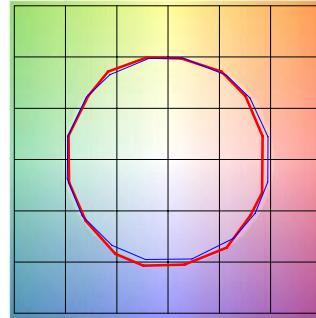

■ Test ■ Reference

HUE BIN	Rf	GRAPHIC SHIFTS %	
		CHROMA	HUE
1	88.8	-5.1%	1.4%
2	89.8	-2.7%	4.1%
3	87.2	0.3%	5.9%
4	92.3	-0.9%	1.0%
5	93.3	1.5%	1.7%
6	92.4	3.6%	-0.2%
7	92.2	-0.9%	-2.4%
8	96.7	-0.4%	-1.1%
9	92.3	-1.2%	3.7%
10	88.9	-0.0%	6.1%
11	86.4	5.1%	7.4%
12	88.2	6.3%	-0.9%
13	87.2	3.8%	-8.1%
14	84.2	3.8%	-11.0%
15	89.8	-2.6%	-4.3%
16	82.7	-3.4%	-11.1%

**3000D** | Rf: 89.8 | Rg: 101.4

Color Vector Graphic

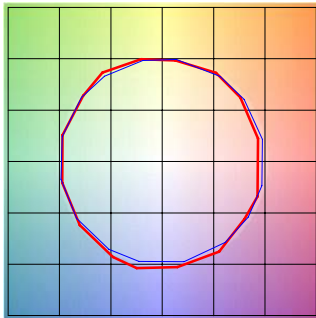

■ Test ■ Reference

HUE BIN	Rf	GRAPHIC SHIFTS %	
		CHROMA	HUE
1	90.2	-4.2%	1.5%
2	90.9	-2.0%	3.7%
3	87.9	0.8%	5.5%
4	92.1	-0.9%	0.6%
5	93.0	1.5%	1.6%
6	92.2	3.9%	-0.2%
7	92.1	-0.3%	-2.0%
8	96.7	0.0%	-1.2%
9	92.5	-0.6%	3.7%
10	88.3	1.1%	7.0%
11	87.2	4.1%	7.4%
12	87.2	6.7%	-1.0%
13	88.2	3.8%	-7.2%
14	85.3	4.3%	-9.9%
15	90.9	-2.2%	-3.6%
16	83.4	-2.2%	-11.2%

**2000K ONLY (2K4K)** | Rf: 84.3 | Rg: 96.9

Color Vector Graphic

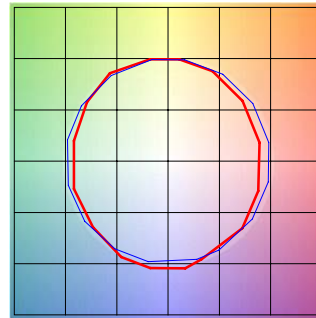

■ Test ■ Reference

HUE BIN	Rf	GRAPHIC SHIFTS %	
		CHROMA	HUE
1	80.3	-8.9%	1.7%
2	79.7	-7.0%	7.8%
3	78.9	-2.9%	10.0%
4	89.5	-0.5%	5.1%
5	94.4	0.7%	1.7%
6	92.1	2.4%	-0.3%
7	89.4	-2.4%	-5.9%
8	89.7	-6.4%	-0.2%
9	86.0	-4.9%	4.6%
10	81.8	-3.4%	9.3%
11	83.1	3.3%	9.7%
12	85.8	5.6%	3.3%
13	85.6	6.2%	-12.8%
14	61.7	-1.9%	-19.0%
15	79.7	-3.3%	-12.9%
16	78.1	-7.9%	-10.6%

**3000K (2K4K)** | Rf: 90.2 | Rg: 101.4

Color Vector Graphic

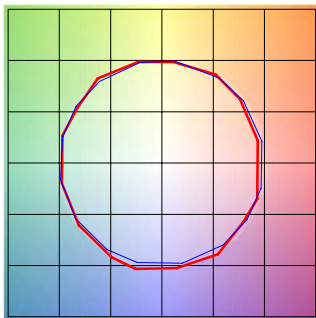

■ Test ■ Reference

HUE BIN	Rf	GRAPHIC SHIFTS %	
		CHROMA	HUE
1	90.9	-3.8%	1.3%
2	91.7	-1.9%	3.3%
3	88.7	0.7%	5.1%
4	92.4	-1.0%	0.7%
5	92.9	0.9%	1.7%
6	93.1	3.3%	-0.6%
7	91.0	-1.8%	-0.4%
8	97.0	0.2%	-1.1%
9	92.8	-0.5%	3.6%
10	88.3	1.0%	7.0%
11	87.1	3.8%	7.8%
12	87.6	6.5%	-0.3%
13	89.3	3.6%	-6.3%
14	86.1	4.5%	-9.1%
15	91.6	-1.9%	-3.1%
16	83.8	-1.5%	-11.2%

**4000K ONLY (2K4K)** | Rf: 89.6 | Rg: 99.1

Color Vector Graphic

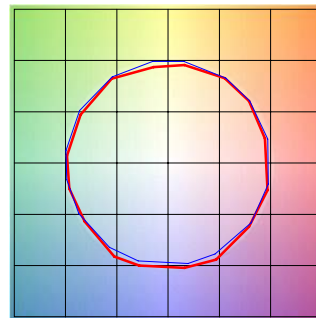

■ Test ■ Reference

HUE BIN	Rf	GRAPHIC SHIFTS %	
		CHROMA	HUE
1	91.3	-2.5%	1.0%
2	95.3	-0.5%	0.5%
3	94.3	-0.7%	1.1%
4	91.1	-3.4%	-1.1%
5	89.5	-5.6%	0.0%
6	94.6	-1.4%	1.3%
7	93.2	-3.0%	2.6%
8	91.3	-1.8%	4.6%
9	86.5	-0.9%	9.1%
10	83.3	-0.5%	9.5%
11	83.3	4.9%	9.0%
12	89.7	4.1%	1.7%
13	90.1	3.6%	-4.3%
14	93.4	5.2%	-2.1%
15	87.4	0.4%	-4.3%
16	86.6	0.4%	-6.1%

PROJECT	FIXTURE TYPE	DATE
---------	--------------	------