



1718 W. Fullerton Chicago, IL 60614  
 Ph: 773.770.1195 • Fax: 773.935.5613  
 www.PureEdgeLighting.com • info@PureEdgeLighting.com  
 © 2016 PureEdge Lighting. All Rights Reserved.

## Installation Instructions for Pipeline 2 Wall/ Vanity with 4" Round Canopy - Center Feed and End Feed

P2WD\_-\_4R\_\_



### IMPORTANT INFORMATION

- This product is ETL listed.
- This instruction shows a typical installation.
- This product is wall mount only.
- This product dimmable with a low voltage electronic dimmer.
- This product mounts to a standard junction box with plaster ring or octagon box.

**SAVE THESE INSTRUCTIONS!**

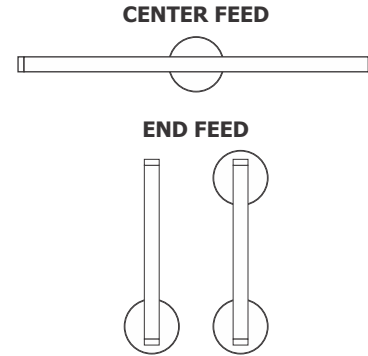

### Section One: Install the Crossbar for Power Canopy

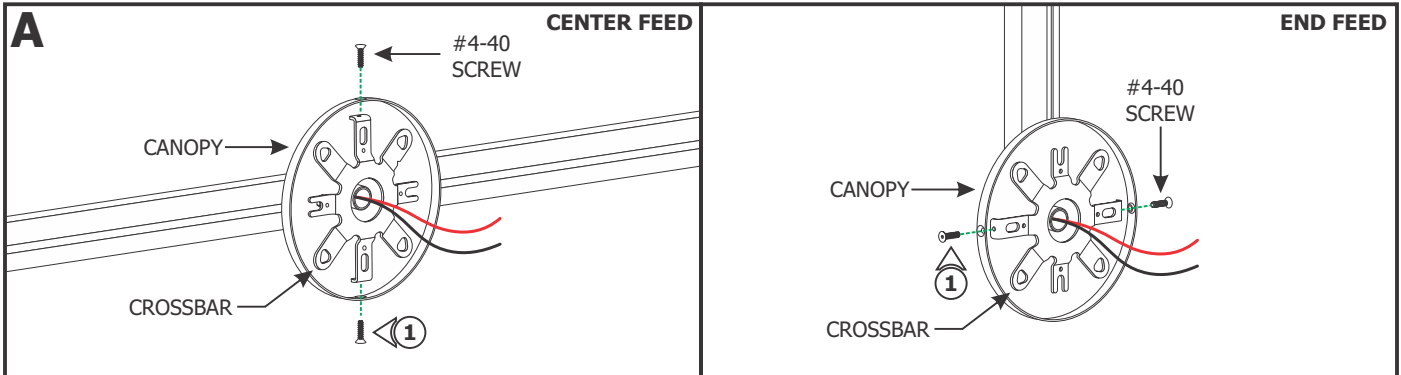

**NOTE:** Before beginning any electrical work, ensure that the power to the junction box is off.

- 1:** Remove the two #4-40 screws on the powered canopy using a 1/16" Allen wrench to remove the crossbar.

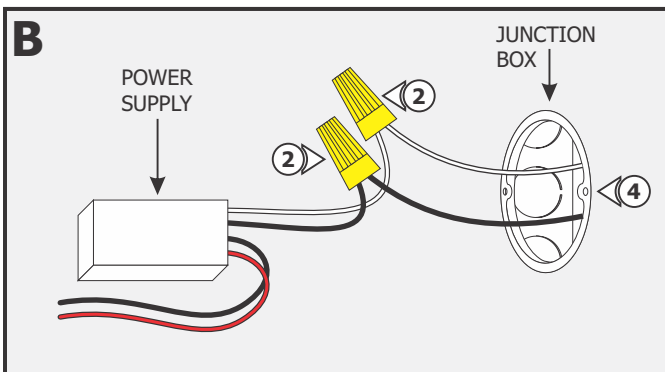

**NOTE:** Omit steps 2 through 4 if using a remote power supply.

- 2:** Connect the neutral wire from the 120VAC circuit to the white wire of the power supply with a wire nut.
- 3:** Connect the hot wire from the 120VAC circuit to the black wire of the power supply using a wire nut.
- 4:** Place the power supply and wires inside the junction box.

- 5:** If using remote power supply, then run the low-voltage 24V wires coming from the remote power supply to the junction box.
- 6:** Feed the low voltage wires from the power supply through the crossbar center hole.

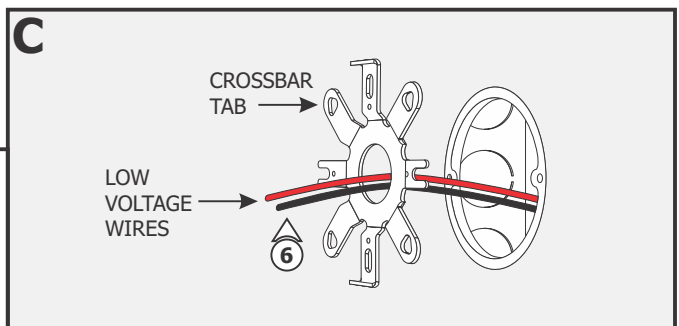

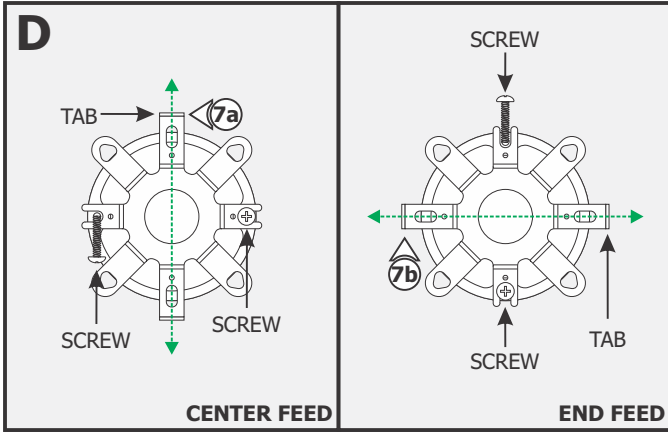

**7a: Center Feed:** Align the crossbar tabs vertically and mount the crossbar to the junction box holes with the two #8-32 screws provided.

**7b: End Feed:** Align the crossbar tabs horizontally and mount the crossbar to the junction box holes using the two #8-32 screws provided.

**NOTE:** Make sure the crossbar is grounded in accordance to local electrical codes.

## Section Two: Install the Center Feed Fixture

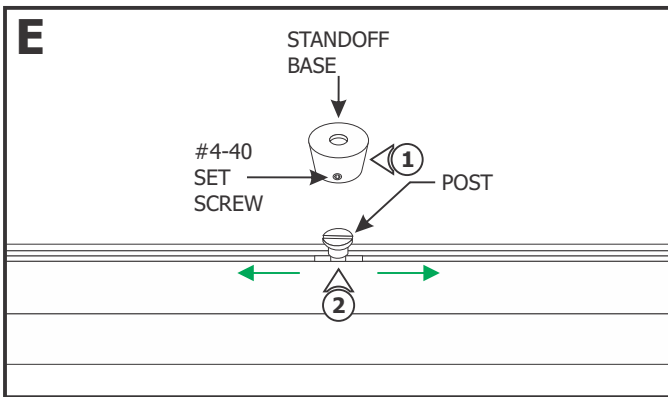

**NOTE:** Omit this section if installing End Feed fixtures. Refer to Section Three.

**1:** Loosen (**Do Not Remove**) the #4-40 set screw on the standoff base using a 0.05" Allen wrench to remove it from the fixture.

**2:** It is recommended to have the posts near the end of the fixture to keep the fixture aligned. Adjust the standoff positions by loosening the post and sliding it across the channel. Tighten the post to secure it in place.

**3:** Repeat steps 1 and 2 for the other standoff post.

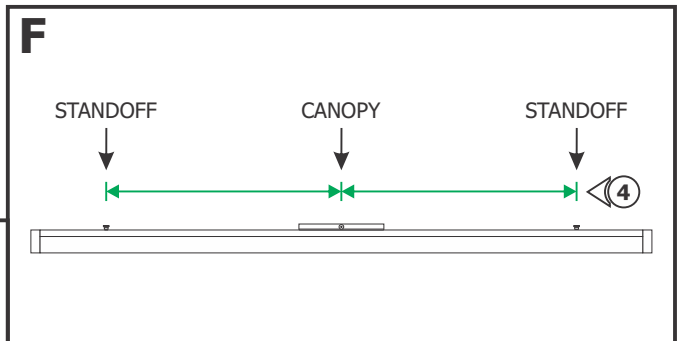

**4:** Measure the distance between the center of the canopy and each standoff post. Mark the locations of the standoff posts on the wall from the center of the junction box.

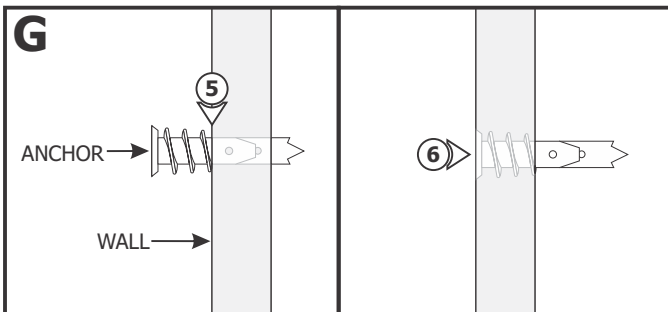

**NOTE:** Omit steps 5 and 6 if mounting directly to a wood surface.

**5:** Tap the anchor onto the marked standoff location up to the threaded portion with a hammer.

**6:** Screw in the threaded portion of the anchor with a Phillips screwdriver.

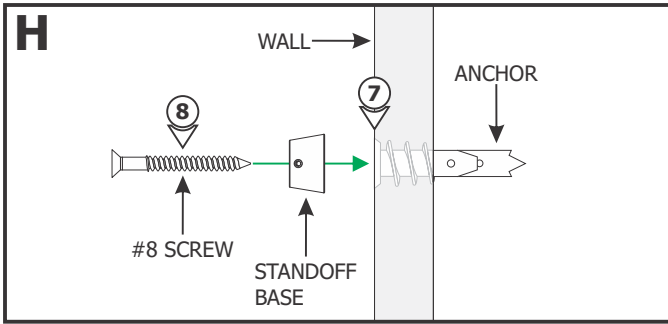

- 7:** Feed the #8 screw through the standoff base into the anchor.
- 8:** Tighten the #8 screw completely into the anchor.
- 9:** Repeat steps 5 through 8 for the other standoff.

- 10:** Connect the low voltage -24VDC black power supply wire to the -24VDC black fixture wire using a wire nut.
- 11:** Connect the low voltage +24VDC red power supply wire to the +24VDC red fixture wire using a wire nut.
- 12:** Place all the wires and wire nut connections inside the junction box.

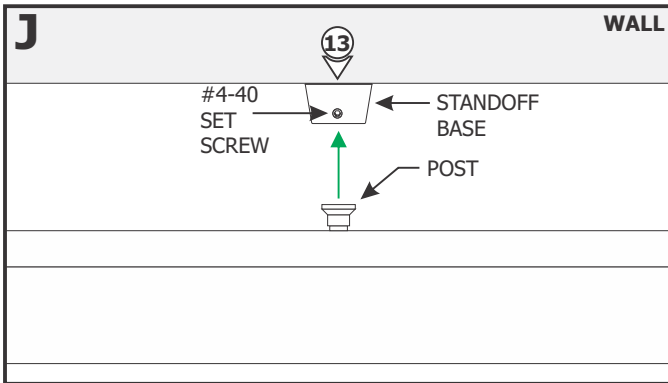
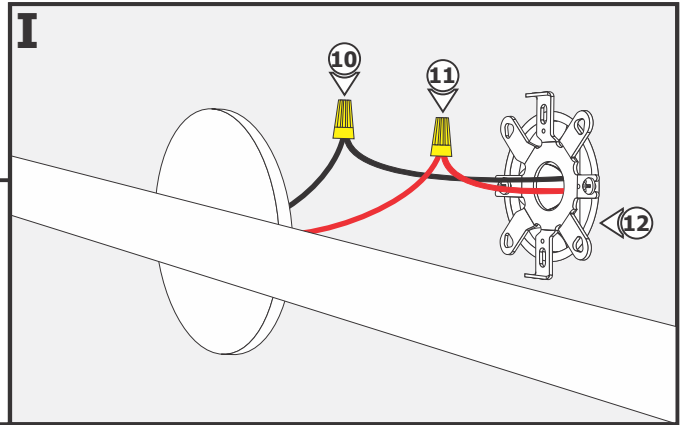

- 13:** Align the posts on the fixture with the standoff bases and secure with the #4-40 set screws.

- 14:** Align the canopy holes with the crossbar holes and secure the fixture to the crossbar with the provided #4-40 screws using a 1/16" Allen wrench.

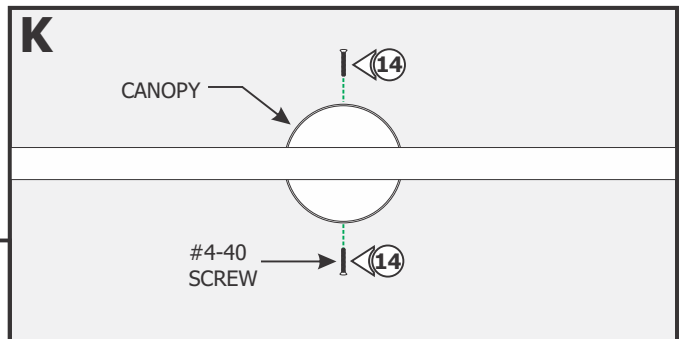

### Section Three: Install the End Feed Fixture

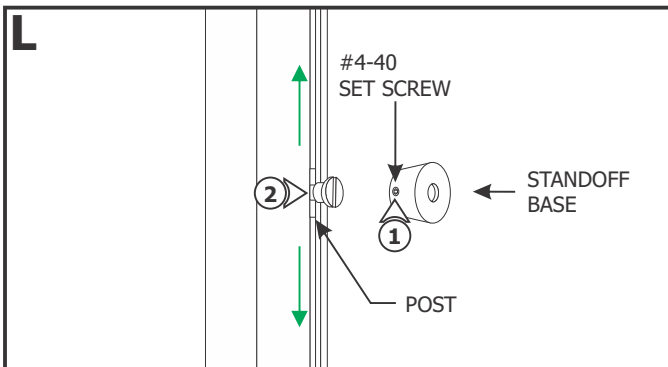

- 1:** Loosen (**Do Not Remove**) the #4-40 set screw on the standoff base using a 0.05" Allen wrench to remove it from the fixture.
- 2:** If necessary, adjust the position of the standoff post by loosening the post and sliding it across the channel. Tighten the post to secure in place.

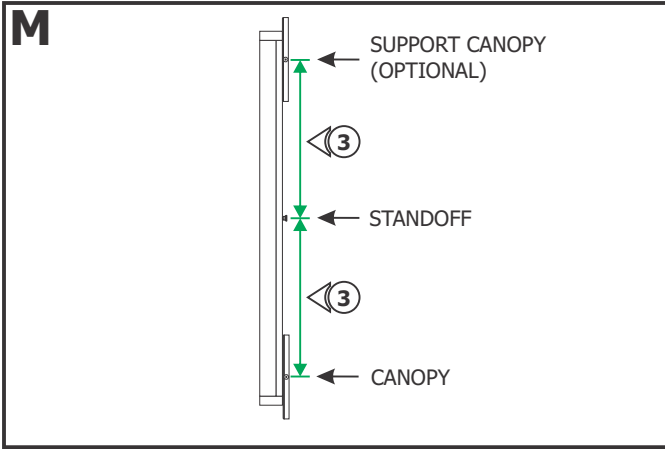

- 3:** Measure the distance between the center of each canopy and the standoff post.
- 4:** Mark the location of the standoff post and optional support canopy on the wall from the center of the junction box. Ensure markings are leveled.

**NOTE:** Omit steps 5 and 6 if mounting directly to a wood surface.

- 5:** Tap the anchor onto the marked standoff location up to the threaded portion with a hammer.
- 6:** Screw in the threaded portion of the anchor with a Phillips screwdriver.

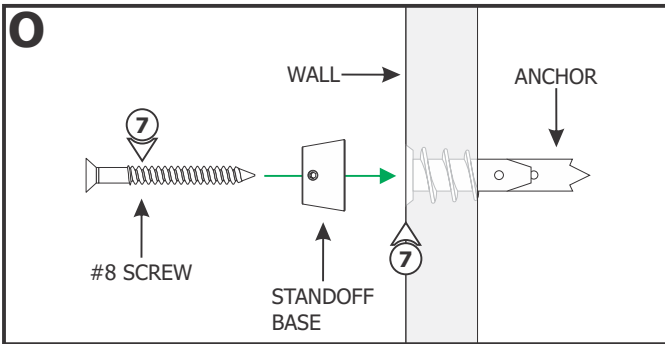
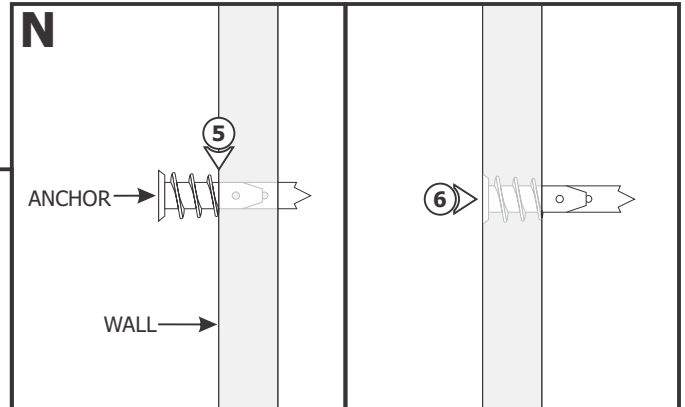

- 7:** Feed the #8 screw through the standoff base into the anchor. Tighten the #8 screw completely into the anchor.
- 8:** Repeat steps 5 through 7 for additional standoffs.

**NOTE:** Omit steps 9 through 13 if the End Feed fixture does not come with a support canopy.

- 9:** Remove the two #4-40 screws on the canopy using a 1/16" Allen wrench to remove the crossbar.
- 10:** Align the crossbar tabs horizontally and center it with the marked canopy location. Mark two additional points through the crossbar.

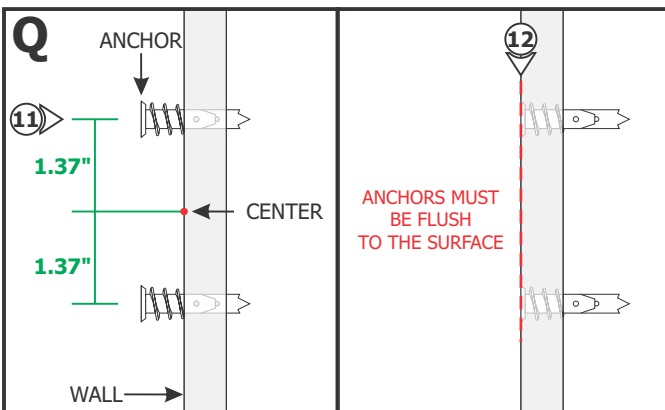
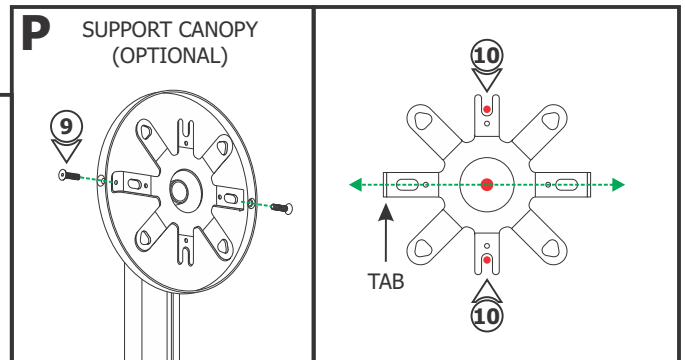

**NOTE:** Omit steps 11 and 12 if mounting directly to a wood surface.

- 11:** Tap the anchors onto the new marked points up to the threaded portion with a hammer.
- 12:** Screw in the threaded portion of the anchors with a Phillips screwdriver.

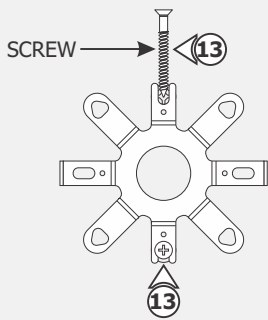
**R**

**13:** Secure the crossbar to the anchors with the two screws provided.

**14:** Connect the low voltage -24VDC black wire from the power supply to the -24VDC black wire from the fixture using a wire nut.

**15:** Connect the low voltage +24VDC red wire from the power supply to the +24VDC red wire from the fixture using a wire nut.

**16:** Place all the wires and wire nut connections inside the junction box.

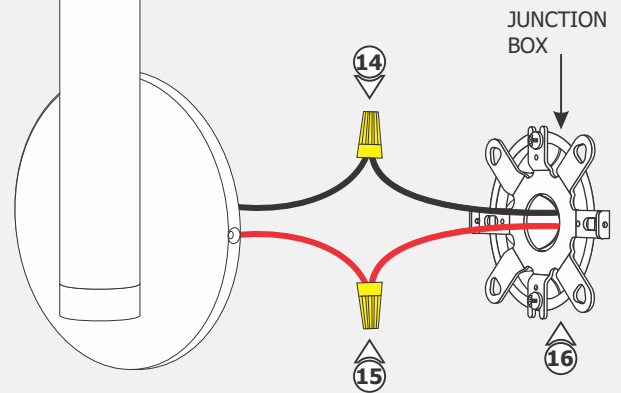
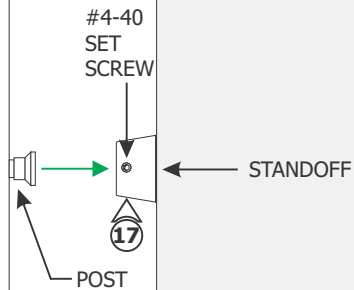
**S****T****WALL**

**17:** Align the post on the fixture with the standoff base and secure with the #4-40 set screw.

**18:** Align the canopies with the crossbars and secure the fixture to the crossbars with the provided #4-40 screws using a 1/16" Allen wrench.

**U**