

# PIPELINE® 2 WALL/VANITY

## 24VDC CENTER FEED STATIC WHITE & WARM DIM

DESIGNED BY GREGORY KAY | MADE IN AMERICA

REV 09.24.20



### DESCRIPTION

The Pipeline 2 Vanity with Floating Canopy is a slender yet powerful linear LED with multiple finish and hardware options making it the perfect fixture for almost any environment, including minimal and transitional spaces. Choose from nine standard Color Temperatures from 2200K-5700K, including two Warm Dim options of 2700K (27D) or 3000K (30D) that dim down to 2000K. The 280° diffused white lens provides clean, uninterrupted illumination in all directions and is available in many standard incremental lengths up to 120". Available in four fine metal finishes with multiple mounting and hardware options. The Pipeline 2 vanity is offered with two types of power options; P2WDP has an electronic low voltage (ELV) power supply that fits inside junction box and is included, P2WDR has a Remote Universal Power Supply (Sold Separately).

### SPECIFICATIONS

**P2WDP** - 24VDC Includes an electronic low voltage power supply that fits within the junction box. 7W up to 72" maximum length.

**P2WDR** - 24VDC Remote, Class 2 power supply (Sold Separately)

**Power Consumed** - 5 or 7 Watts per Foot

**Performance** - Up to 986 Lumens per foot

### MOUNTING OPTIONS

Fixture mounts horizontally or vertically. Floating Canopy can mount anywhere along the length of the channel to accommodate off-center junction boxes.

**C1R** - Reveals only the slightest outline of the canopy that mounts to a Slim Profile junction box (included) recommended for new construction application

**C4R** - Round 4.6" Canopy mounts to a standard 4" junction box

### FINISHES



Satin Black **BK**    Chrome **CH**    Satin Nickel **SN**    White **WH**

### ORDERING

- Standard Length Options from 9"-120"
- Ordering Code refers to Lens Lengths - see page 2 for Overall Fixture Dimensions
- Custom Lengths Available

### LENS

- Diffused White 280° Lens, 174° beam angle

### LAMPING

- Static White color temperatures from 2200K-5700K
- Warm Dim: 2700K (27D) and 3000K (30D) that dim down to 2000K (5W Only)
- Designer-grade Color Rendering 95+CRI
- 50,000 Hour Lamp Life

### REMOTE POWER SUPPLIES\*, DIMMERS & CONTROLS (SOLD SEPARATELY)

- Uni-Driver: Universal Dimming (**TRIAC, ELV, 0-10V**)
- Electronic Low Voltage (**ELV**)
- Lutron Hi-Lume®

\*In-Wall Mounting Kits available for select power supplies

### APPLICATIONS

Designed for Indoor and Damp Locations - Ideal applications in Residential, Commercial, and Hospitality Environments, including Bathroom Vanities, Resort Spas, Hotels, Health, and Wellness Clubs.

### COMPLIANCE / WARRANTY

5-year pro-rated warranty. Damp Location, ETL listed, ADA Title 24 Remote power supply only, Class 2 wiring, Made in America

### CONFIGURATOR

Use our Configurator to see List Price, Complete Ordering Code and Overall Length. [Pipeline 2 Wall Vanity Configurator](#)

System	Wattage	Canopy Type	Lens Length (Inches)	Color Temperature	Finish
<b>P2WDP</b>	<b>5W</b>	<b>C4R</b>	<b>72</b>	<b>30K</b>	<b>SN</b>
<b>P2WDP</b> Pipeline 2 Wall Vanity with ELV Power Supply in Junction Box (7 watt, Max Length 72")* <b>P2WDR</b> Pipeline 2 Wall Vanity with Remote Power Supply, 24VDC Class 2, Title 24**	<b>5W</b> 5 Watts <b>7W</b> 7.5 Watts	<b>C1R</b> Center Feed 1" Rectangular JBox and Canopy <b>C4R</b> Center Feed, 4.6" Round Canopy	<b>STATIC WHITE</b> 10, 12, 15, 17, 20, 22, 24, 27, 29, 32, 34, 36, 39, 41, 44, 46, 48, 51, 53, 56, 58, 60, 63, 65, 68, 70, 72, 75, 77, 80, 82, 84*, 87, 89, 92, 94, 96, 99, 101, 104, 106, 108, 111, 113, 116, 118, 120  <b>WARM DIM</b> 9, 12, 15, 18, 21, 24, 27, 30, 33, 36, 39, 42, 45, 48, 51, 54, 57, 60, 63, 66, 69, 72, 75, 78, 81, 84, 87, 90, 93, 96, 99, 102, 105, 108, 111, 114, 117, 120	<b>22K</b> 2200K Amber White <b>24K</b> 2400K Very Warm White <b>27K</b> 2700K Incandescent White <b>27D</b> 2700K Warm Dim to 2000K (5W Only) <b>30K</b> 3000K Warm White <b>30D</b> 3000K Warm Dim to 2000K (5W Only) <b>35K</b> 3500K Neutral White <b>40K</b> 4000K Cool White <b>57K</b> 5700K Daylight White	<b>BK</b> Satin Black <b>CH</b> Chrome <b>SN</b> Satin Nickel <b>WH</b> White

\*7W Maximum Length is 72" for P2WDP

\*\*Refer to pages 4-6 for Remote Power Supply options. Universal Power Supplies are Title 24 Compliant.

\*84" Maximum length for Chrome.

\*\*Ordering code refers to Lens Length Only. See actual dimensions on page 2.

PROJECT	FIXTURE TYPE	DATE
---------	--------------	------

## OVERALL DIMENSIONS (INCHES)

STATIC WHITE (22K, 24K, 27K, 30K, 35K, 40K & 57K)						
Ordering Code Example	Lens Length	Overall Length Dimension 'A'	Total Wattage (5W)	Total Lumens 3000K (5W)	Total Wattage (7W)	Total Lumens 3000K (7W)
12	12	13	5	557.0	7.5	911
20	19.2	20.2	8	892	12.0	1443
24	24	25	10	1103	15.0	1803
32	31.2	32.2	13	1434	19.5	2344
36	36	37	15	1654	22.5	2705
48	48	49	20	2206	30.0	3607
60	60	61	25	2757	37.5	4509
72*	72	73	30	3309	45.0	5411
80	79.2	80.2	33	3639	49.5	5952
84**	84	85	35	3860	52.5	6313
87	86.4	87.4	36	3970		
99	97	98	41	4522		
108	108	109	45	4963		
120	120	121	50	5514		

WARM DIM (27D & 30D)				
Ordering Code Example	Lens Length	Overall Length Dimension 'A'	Total Wattage (5W)	Total Lumens 3000K (5W)
12	12	13	5	618
15	15	16	6.5	764
18	18	19	7.5	917
24	24	25	10	1223
36	36	37	15	1835
48	48	49	20	2447
60	60	61	25	3059
72	72	73	30	3670
96	96	97	40	4894
120	120	121	50	6118

\*7W Max Length \*\*Maximum length for Chrome is 84"

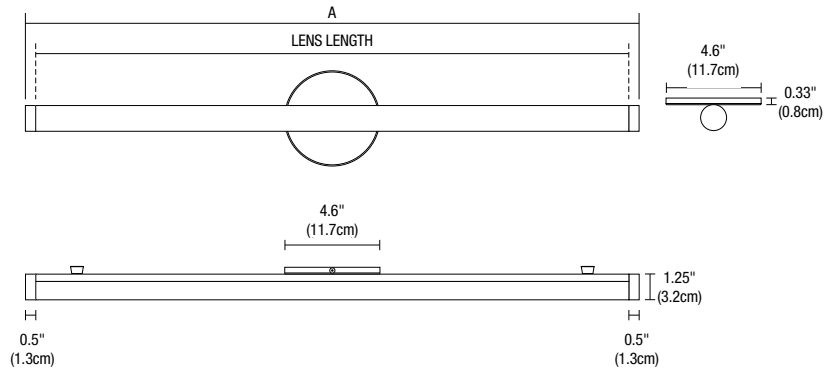
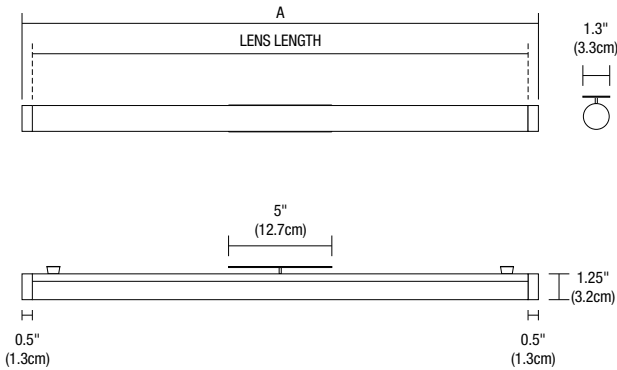

PROJECT		FIXTURE TYPE		DATE	
---------	--	--------------	--	------	--

## FINISHES



P2WDP-5W-C4R-32-30K-BK



P2WDP-5W-C4R-32-30K-CH



P2WDP-5W-C4R-32-30K-SN



P2WDP-5W-C1RE-32-30K-WH



CHROME



SATIN BLACK



SATIN NICKEL



WHITE

## LAMP DATA Lamp Data for Pipeline 2 Wall Vanity - Center Feed

PIPELINE VANITY																
STATIC WHITE & WARM DIM																
DESCRIPTION	5w (4.4 watts)						7w (7.3 watts)									
	22K	24K	27K	27D*	30K	30D*	35K	40K	57K	22K	24K	27K	30K	35K	40K	57K
WATTS PER FOOT																
COLOR TEMPERATURE	386	429	471	389	515	425	590	641	682	558	620	681	744	852	926	986
LUMENS PER FOOT (lm/ft)	88	97	107	81	117	89	134	146	155	77	85	93	102	117	127	135
LUMENS PER WATT (lm/w)	85+	90+	95+	95+	95+	95+	85+	84	84	85+	90+	95+	95+	85+	84	84
CRI																

\*27D, 30D - Warm Dim (4.8 Watts)

### 8' CHANNEL | 174° BEAM SPREAD | 3000K

5 Watts 174°	
Distance	Foot Candles
1'	201
1.5'	134
2'	102
3'	68
4'	49
5'	37
6'	29
7'	23
8'	18

7 Watts 174°	
Distance	Foot Candles
1'	303
1.5'	203
2'	148
3'	99
4'	71
5'	46
6'	35
7'	24
8'	25

### CANDLE POWER DISTRIBUTION 174°

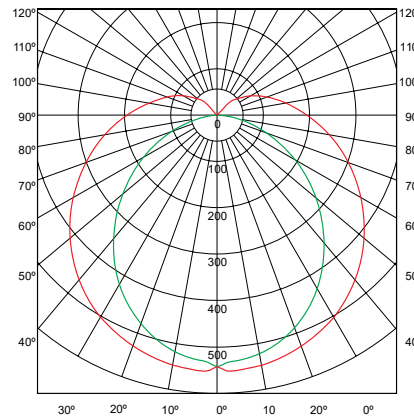

### PIPELINE 2 - 174° Beam Spread

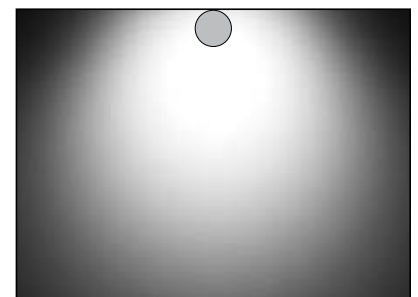

PROJECT	FIXTURE TYPE	DATE
---------	--------------	------



**IN WALL MOUNTING OPTIONS**

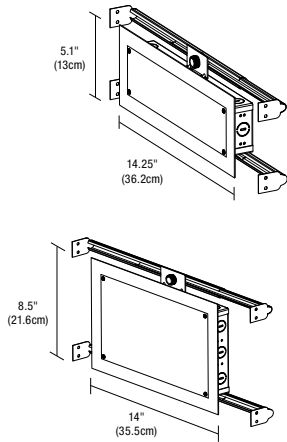

**In-Wall Mounting Kit:** Includes power supply, box cover and stud hangers for installing Junction Box in wall. Select "IW" in the options section of compatible power supply ordering codes if an In-Wall Mounting Kit is needed.

**Ordering Codes 5.1 x 14.25 inch:** PSB-40W-UNI-24VDC-IW  
PSB-60W-UNI-24VDC-IW  
PSB-96W-UNI-24VDC-IW

**Ordering Codes 8.5 x 14.25 inch:** PSB-2X40W-UNI-24VDC-IW  
PSB-2X60W-UNI-24VDC-IW  
PSB-2X96W-UNI-24VDC-IW

**WIRING DIAGRAMS UNIVERSAL POWER SUPPLY**

**Application:** ELV dimming for Static White and Warm Dim

**Dimming:** Dimmable with ELV dimmer: Legrand, Adorne ADTP703TU; Lutron: Diva DVELV-300P, Skylark SELV-300P, Maestro MAELV-600 and Radio Ra 2

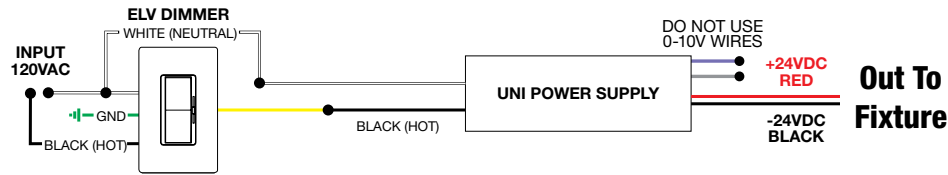

**Application:** 0-10V dimming for Static White

**Dimming:** Dimmable with 0-10V dimmer: Philips Sunrise: SR1200ZTUNV; Lutron Diva: DVTV-WH, DVSTV-WH; Lutron Nova T: NTSTV-DV-XX; Lutron Grafix EYE QS: QSGRJ-XP; Lutron Radio Ra2: RRD-10ND; Leviton: LEV40050; Leviton IP710-LFZ; Legrand: ADPD4FBL3P2W4

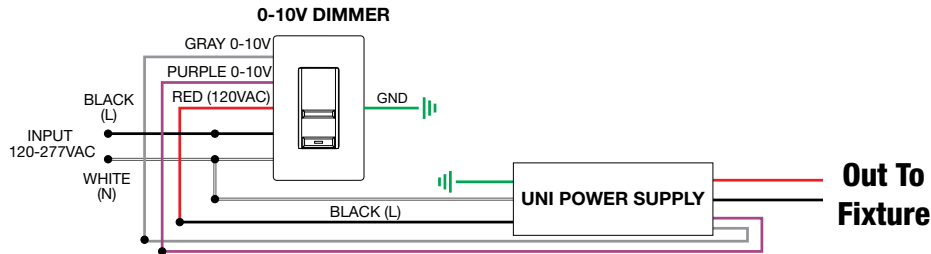

PROJECT		FIXTURE TYPE		DATE	
---------	--	--------------	--	------	--

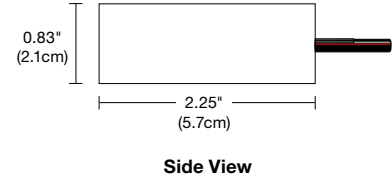
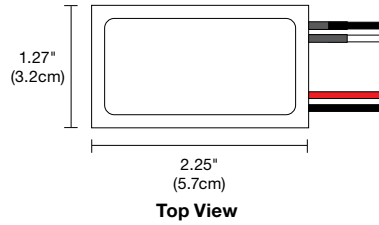
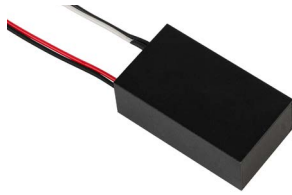

**DESCRIPTION**

Compact, lightweight remote electronic 60W/24V LED Power Supply\* converts standard 120VAC voltage to 24VDC and features built-in short-circuit protection. The low voltage output may be dimmed using an electronic low voltage dimmer. The Power Supply is certified to be used inside a standard Junction Box enclosure. Power Supply features short circuit and overload protection. Indoor applications only.

*\*Electrical Panels using Siemens/Murray AFCI breakers are not compatible with this ELV transformer. Use 0-10 Volt power supplies with this breaker.*

**APPLICATIONS**

Indoor\*  
 To avoid overheating the power supply, install it in a ventilated remote location where air flows. Maintain proper spacing among power supplies when multiple power supplies are installed in the same remote location.

- POWER INPUT** 120 volts AC, 60Hz
- POWER OUTPUT** Class 2; 24 volts DC 2.5A 60 watt maximum
- DIMENSIONS** 2.25" x 1.25" x 0.83"
- DIMMER TYPE** Electronic Low Voltage Dimmer Lutron: Diva #DVELV-300P; Skylark #SELV-300P; Maestro #MAELV-600

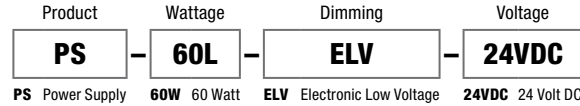
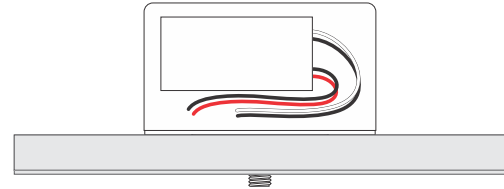

**SAMPLE WIRING DIAGRAMS 24VDC ELV**

- Application:** ELV dimming for Static White
- Dimming:** Dimmable with ELV dimmer: Legrand, Adorne ADTP703TU; Lutron: Diva DVELV-300P, Skylark SELV-300P, Maestro MAELV-600 and Radio Ra 2

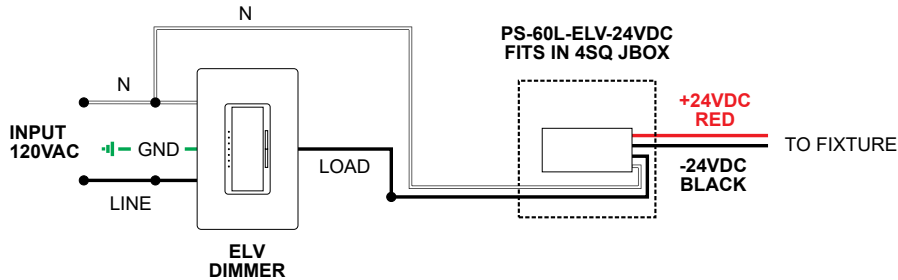

PROJECT		FIXTURE TYPE		DATE	
---------	--	--------------	--	------	--

# WALL/VANITY TM30 DATA

## 24VDC CENTER FEED STATIC WHITE & WARM DIM

**TM-30-15 DATA:** The data below is for SS5C and SS7C bare LED Soft Strips. Consistent color temperatures throughout a single strip and among multiple strips is possible through a 3 phase binning process in which each order is inspected with a color meter to ensure uniformity.

**2200K** | Rf: 83.9 | Rg: 94.9  
Color Vector Graphic

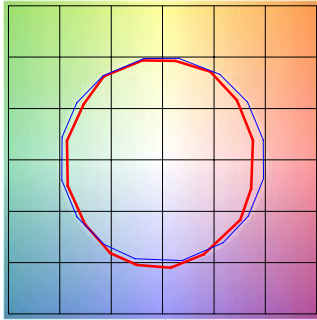

■ Test ■ Reference

GRAPHIC SHIFTS %			
HUE BIN	Rf	CHROMA	HUE
1	77.6	-10.0%	1.8%
2	80.7	-7.5%	7.0%
3	79.5	-2.9%	8.9%
4	90.5	-3.1%	2.4%
5	93.9	-1.3%	1.9%
6	91.9	-0.9%	-0.2%
7	87.6	-6.3%	-2.7%
8	90.5	-5.4%	2.7%
9	83.8	-4.7%	6.5%
10	81.2	-2.5%	10.0%
11	83.3	3.9%	9.4%
12	86.4	5.6%	2.6%
13	86.2	4.5%	-12.4%
14	64.3	-1.0%	-21.9%
15	85.1	-4.4%	-7.5%
16	75.0	-9.9%	-12.0%

**2400K** | Rf: 91.2 | Rg: 96.8  
Color Vector Graphic

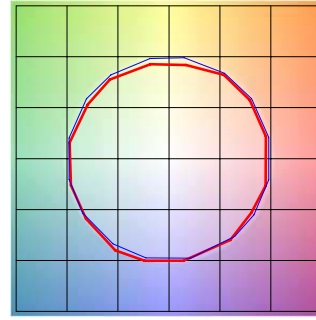

■ Test ■ Reference

GRAPHIC SHIFTS %			
HUE BIN	Rf	CHROMA	HUE
1	92.0	-2.4%	1.5%
2	94.7	-2.1%	0.0%
3	95.4	-1.9%	-0.1%
4	88.7	-6.7%	-3.1%
5	92.8	-5.6%	1.0%
6	92.7	-3.4%	3.4%
7	89.9	-4.3%	4.1%
8	92.4	-1.4%	4.4%
9	89.0	-0.6%	5.8%
10	88.9	0.4%	6.2%
11	89.7	4.0%	5.4%
12	92.6	3.0%	-0.7%
13	90.9	1.1%	-7.0%
14	89.9	0.5%	-5.8%
15	92.1	-3.2%	0.1%
16	88.9	-1.7%	-6.3%

**2700K** | Rf: 87.7 | Rg: 96.1  
Color Vector Graphic

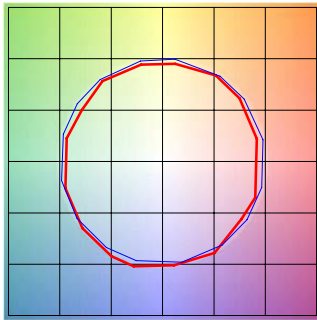

■ Test ■ Reference

GRAPHIC SHIFTS %			
HUE BIN	Rf	CHROMA	HUE
1	86.4	-5.6%	2.3%
2	89.7	-3.3%	3.1%
3	90.5	-1.5%	3.8%
4	90.0	-4.3%	1.1%
5	92.9	-3.7%	0.2%
6	93.5	-2.5%	-0.8%
7	86.3	-7.2%	2.5%
8	90.7	-4.0%	3.2%
9	85.2	-2.4%	8.1%
10	81.7	0.9%	10.8%
11	85.4	4.5%	8.9%
12	88.7	5.7%	-1.4%
13	88.3	1.3%	-7.9%
14	85.1	2.4%	-10.4%
15	88.1	-4.8%	-2.7%
16	81.7	-4.3%	-10.9%

**3000K** | Rf: 88.1 | Rg: 99.7  
Color Vector Graphic

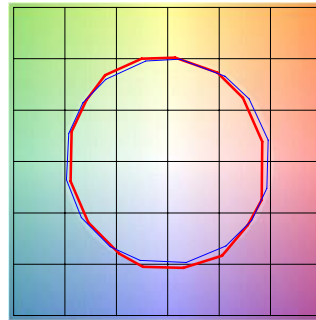

■ Test ■ Reference

GRAPHIC SHIFTS %			
HUE BIN	Rf	CHROMA	HUE
1	87.7	-5.9%	-0.3%
2	87.9	-4.4%	4.3%
3	82.9	-1.2%	7.9%
4	89.9	0.6%	4.7%
5	92.7	3.0%	3.5%
6	92.7	3.6%	-1.7%
7	90.8	-1.3%	-4.4%
8	93.7	-2.5%	-2.2%
9	91.7	-3.7%	2.3%
10	85.5	-2.8%	7.8%
11	83.3	0.7%	11.0%
12	86.4	5.5%	3.8%
13	90.6	4.6%	-3.6%
14	85.6	5.9%	-8.4%
15	89.5	-0.6%	-5.7%
16	82.6	-2.7%	-12.0%

**3500K** | Rf: 86.1 | Rg: 95.5  
Color Vector Graphic

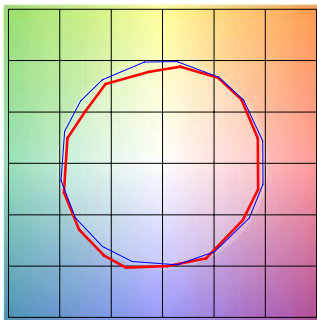

■ Test ■ Reference

GRAPHIC SHIFTS %			
HUE BIN	Rf	CHROMA	HUE
1	86.6	-4.2%	3.4%
2	91.7	-1.4%	1.8%
3	94.9	-0.7%	0.4%
4	87.9	-4.5%	-4.1%
5	85.9	-10.3%	-2.7%
6	89.8	-5.2%	-0.4%
7	79.6	-9.5%	6.5%
8	87.6	-4.0%	5.7%
9	81.4	-0.5%	11.8%
10	78.3	3.3%	11.4%
11	85.7	6.3%	6.1%
12	86.3	7.1%	-4.6%
13	86.1	-0.7%	-9.6%
14	85.1	0.8%	-10.4%
15	83.4	-4.1%	-5.3%
16	82.5	-3.6%	-5.7%

**4000K** | Rf: 87.6 | Rg: 96.8  
Color Vector Graphic

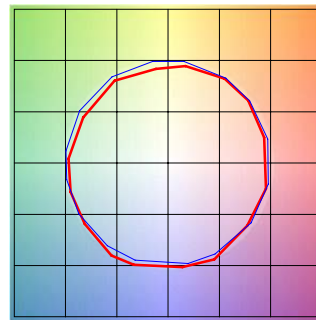

■ Test ■ Reference

GRAPHIC SHIFTS %			
HUE BIN	Rf	CHROMA	HUE
1	89.0	-3.1%	2.1%
2	93.2	-0.9%	1.3%
3	94.3	-1.1%	0.7%
4	89.5	-4.0%	-2.3%
5	87.6	-7.8%	-1.8%
6	92.2	-4.6%	0.1%
7	87.4	-6.6%	3.6%
8	85.7	-3.8%	7.0%
9	81.5	-1.3%	12.4%
10	80.0	0.9%	11.4%
11	83.3	5.9%	8.7%
12	89.7	4.8%	-0.3%
13	88.5	2.4%	-6.3%
14	92.7	4.0%	-3.8%
15	86.1	-1.6%	-4.5%
16	85.0	-1.4%	-5.0%

PROJECT	FIXTURE TYPE	DATE
---------	--------------	------



# WALL/VANITY TM30 DATA

## 24VDC CENTER FEED STATIC WHITE & WARM DIM

**TM-30-15 DATA:** The data below is for SS5C and SS7C bare LED Soft Strips. Consistent color temperatures throughout a single strip and among multiple strips is possible through a 3 phase binning process in which each order is inspected with a color meter to ensure uniformity.

**5700K** | Rf: 80.3 | Rg: 91.5

Color Vector Graphic

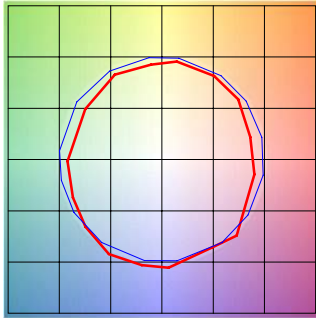

■ Test ■ Reference

HUE BIN	Rf	GRAPHIC SHIFTS %	
		CHROMA	HUE
1	73.8	-11.2%	2.6%
2	83.7	-5.5%	5.8%
3	84.2	-4.0%	5.5%
4	85.8	-3.5%	1.3%
5	85.3	-7.1%	0.6%
6	89.2	-5.8%	-2.2%
7	81.5	-10.7%	1.2%
8	75.7	-9.7%	8.5%
9	74.9	-7.8%	18.8%
10	67.8	-1.6%	18.0%
11	76.1	5.5%	12.0%
12	90.8	4.9%	-1.6%
13	83.6	5.0%	-9.5%
14	81.7	-1.2%	-10.0%
15	69.0	2.0%	-22.8%
16	83.2	-8.5%	-1.0%

**2700D** | Rf: 89.5 | Rg: 100.8

Color Vector Graphic

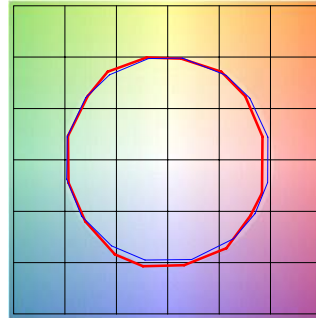

■ Test ■ Reference

HUE BIN	Rf	GRAPHIC SHIFTS %	
		CHROMA	HUE
1	88.8	-5.1%	1.4%
2	89.8	-2.7%	4.1%
3	87.2	0.3%	5.9%
4	92.3	-0.9%	1.0%
5	93.3	1.5%	1.7%
6	92.4	3.6%	-0.2%
7	92.2	-0.9%	-2.4%
8	96.7	-0.4%	-1.1%
9	92.3	-1.2%	3.7%
10	88.9	-0.0%	6.1%
11	86.4	5.1%	7.4%
12	88.2	6.3%	-0.9%
13	87.2	3.8%	-8.1%
14	84.2	3.8%	-11.0%
15	89.8	-2.6%	-4.3%
16	82.7	-3.4%	-11.1%

**3000D** | Rf: 89.8 | Rg: 101.4

Color Vector Graphic

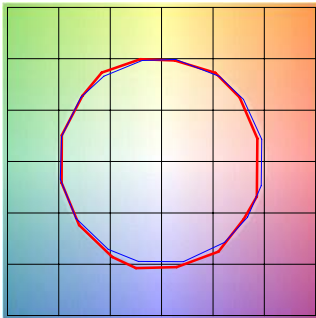

■ Test ■ Reference

HUE BIN	Rf	GRAPHIC SHIFTS %	
		CHROMA	HUE
1	90.2	-4.2%	1.5%
2	90.9	-2.0%	3.7%
3	87.9	0.8%	5.5%
4	92.1	-0.9%	0.6%
5	93.0	1.5%	1.6%
6	92.2	3.9%	-0.2%
7	92.1	-0.3%	-2.0%
8	96.7	0.0%	-1.2%
9	92.5	-0.6%	3.7%
10	88.3	1.1%	7.0%
11	87.2	4.1%	7.4%
12	87.2	6.7%	-1.0%
13	88.2	3.8%	-7.2%
14	85.3	4.3%	-9.9%
15	90.9	-2.2%	-3.6%
16	83.4	-2.2%	-11.2%

PROJECT	FIXTURE TYPE	DATE
---------	--------------	------