

PSB-3X100W-24VDC-2XK 3X100 WATT 24 VOLT DC TUNABLE WHITE POWER SUPPLY WITH DMX DRIVER

REV.07.31.18

DESIGNED BY GREGORY KAY | ASSEMBLED IN AMERICA

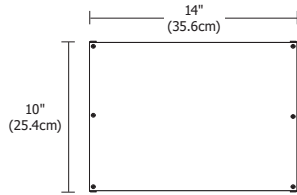

Top View

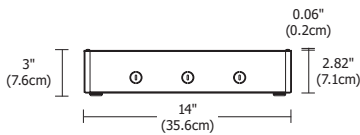

Side View

Description

Accepts input voltage in a range of 120-277VAC and outputs 24VDC power up to 3x100 watts. The integrated Tunable White Driver receives signals from CDMX1-2XK to control Tunable White color mixing and light intensity. Power Supply features short circuit and overload protection. Indoor applications only.

Applications

Indoor*

* To avoid overheating the power supply, install it in a ventilated remote location where air flows. Maintain proper spacing among power supplies when multiple power supplies are installed in the same remote location.

Power Input

120-277VAC, 50/60Hz

Power Output

Class 2; 24 volts DC 3x4.16A at 3x100 watts maximum

Dimensions

17" x 13" x 3"

Compatible Controllers

Tunable White Touch Controller (CDMX1-2XK)

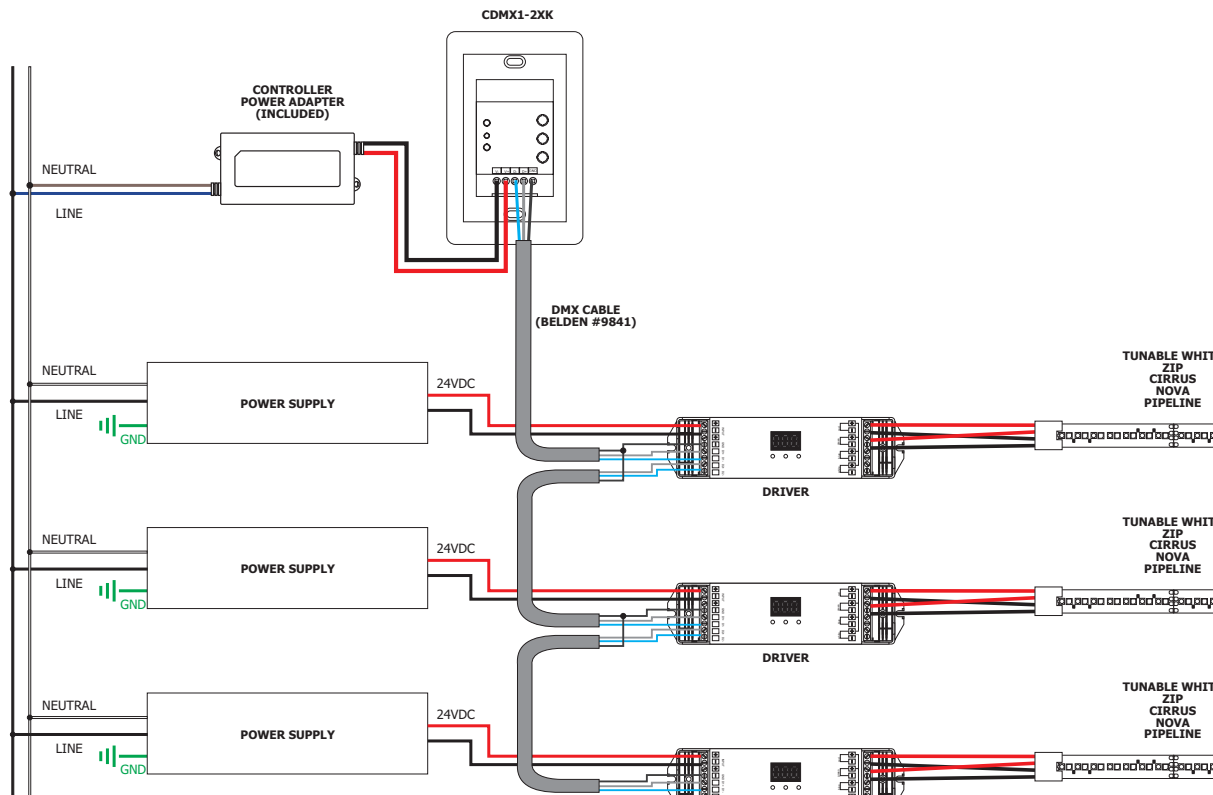
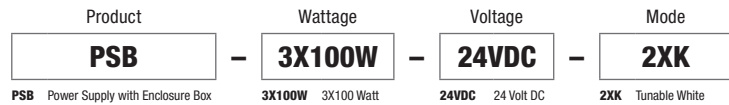

PROJECT		FIXTURE TYPE		DATE	
---------	--	--------------	--	------	--