

SOFT LINE INDIRECT LIGHTING SYSTEM

1.25" WIDE SUSPENDED LED LIGHTING SYSTEM, 24VDC REMOTE POWER SUPPLY

DESIGNED BY DEREK PORTER | MADE IN AMERICA | US PATENT ISSUED

REV 10.06.20



DESCRIPTION

Soft Line Indirect LED Lighting System provides soft ambient illumination for decorative and architectural applications. The suspended aluminum tape is available with commercial-grade Static White, RGB, RGB+W, Warm Dim or Dynamic Tunable White LED Strips, in single or double configurations. For compact shipment and storage, Soft Line coils like a retractable tape measure. When uncoiled, Soft Line becomes a 1.25 inch wide cupped, rigid channel that spans opposing walls, ceiling or floor surfaces. The field-cuttable channel allows custom lengths up to 40 feet. The cupped aluminum form contributes to the luminaire's structural rigidity, acts as a heat sink and shields system components from view. Adjustable turnbuckles support Soft Line, creating a 3-dimensional look that is as functional as it is visually interesting. Fixtures include a 5 year pro-rated warranty. For custom designs and quotes, send drawings to design@PureEdgeLighting.com.

APPLICATIONS

Wherever an indirect light source can be used, including: indoor, kitchens, homes, offices, retail, hotels, clubs, displays, media room and conference rooms

POWER FEED & NON-POWER FEED TURNBUCKLES (INCLUDED)

Turnbuckles support Soft Line on any angle from 0-60 degrees, feed power from one end and mount to standard 4 inch square electrical junction box with round plaster ring. Turnbuckles may be reversed and mounted (opposite the power feed) to a ceiling, wall or floor.

SOFT LINE STANDOFF (SOLD SEPARATELY)

The field-cuttable 24 inch long standoff provides additional mounting options on opposing wall, ceiling or floor surfaces. Stem may be cut down to 4 inches.

REMOTE POWER SUPPLIES*, DIMMERS & CONTROLS (SOLD SEPARATELY)

- UNI Driver: Universal Dimming (**TRIAC, ELV, 0-10V**) with corresponding dimmer
- Lutron Hi-Lume®

*In-Wall Mounting Kits available for select power supplies

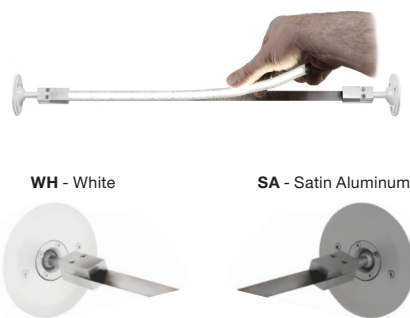

Soft Line Turnbuckles (included)



Soft Line Channel (included)

Product	Voltage	Length in Feet	Color Temperature	Turnbuckle Finish	
SL	24V	20	30K	SA	
SL SoftLine with Single Line of Soft Strip, 5 watts per foot, RGBW 6 watts per foot max length 16 ft before re-feeding at both ends	24V 24 Volt	10 10 Feet 30 30 Feet 15 15 Feet 35 35 Feet 20 20 Feet* 40 40 Feet 25 25 Feet	22K 2200K Amber White 24K 2400K Very Warm White 27K 2700K Incandescent White 27D 2700K Warm Dim 30K 3000K Warm White 30D 3000K Warm Dim 35K 3500K Neutral White 40K 4000K Cool White 57K 5700K Daylight White	40K 4000K Cool White 57K 5700K Daylight White 2K4K* Tunable/Dynamic White 2000K - 4000K (5W) 27K6 Tunable White 2700K-6500K** RGB Red, Green, Blue	SA Satin Aluminum WH White
*Lengths over 20 feet require power feed at both ends **5W **6W					

Product	Voltage	Length in Feet	Color Temperature	Turnbuckle Finish	
SLD	24V	20	57K	SA	
SLD SoftLine with Dual Line of Soft Strip, 2 x 2.5 Watts per foot	24V 24 Volt	10 10 Feet 30 30 Feet 15 15 Feet 35 35 Feet 20 20 Feet 40 40 Feet 25 25 Feet	22K 2200K Amber White 24K 2400K Very Warm White 27K 2700K Incandescent White 27D 2700K Warm Dim 30K 3000K Warm White 30D 3000K Warm Dim 35K 3500K Neutral White 40K 4000K Cool White 57K 5700K Daylight White	2K4K* Tunable/Dynamic White 2000K - 4000K RGB22K** Red, Green, Blue + 22K RGB24K** Red, Green, Blue + 24K RGB27K** Red, Green, Blue + 27K RGB30K** Red, Green, Blue + 30K RGB35K** Red, Green, Blue + 35K RGB40K** Red, Green, Blue + 40K RGB57K** Red, Green, Blue + 57K RGB Red, Green, Blue	SA Satin Aluminum WH White
*5W **6W					

PROJECT	FIXTURE TYPE	DATE
---------	--------------	------

SOFT LINE INDIRECT LIGHTING SYSTEM

1.25" WIDE SUSPENDED LED LIGHTING SYSTEM, 24VDC REMOTE POWER SUPPLY

REV 10.06.20

Lamp Data: Lamp data for Uplight Channel

DESCRIPTION	SLS								
	SoftLine Single Line								
	5w								
WATTS PER FOOT									
COLOR TEMPERATURE	22K	27K	27D*	30K	30D*	35K	40K	57K	
LUMENS PER FOOT (lm/ft)	418	510	384	557	365	638	694	738	
LUMENS PER WATT (lm/w)	95	115	77	126	73	145	157	167	
CRI	85+	95+	92+	95+	92+	85+	85+	85+	

*27D, 30D - Warm Dim (4.8 Watts)

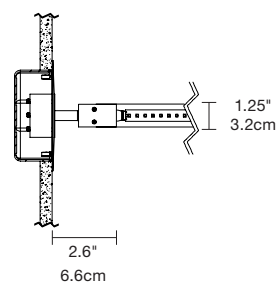

Power Feed Turnbuckle Included with SLT-SA

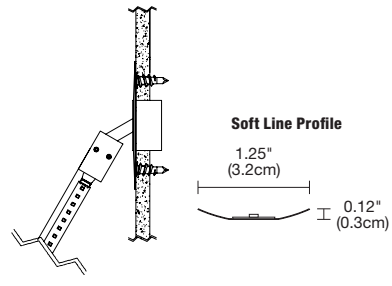

Non-Power Feed Turnbuckle Included with SLT-SA

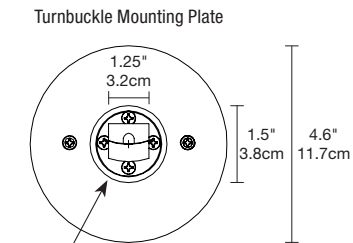
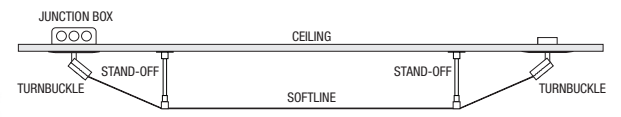
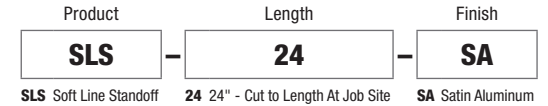

Plaster to inside lip of turnbuckle

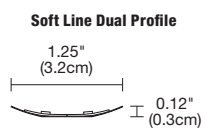

4.0 JBOX WITH 4" SQUARE OPENING COVER 2.75" OPENING

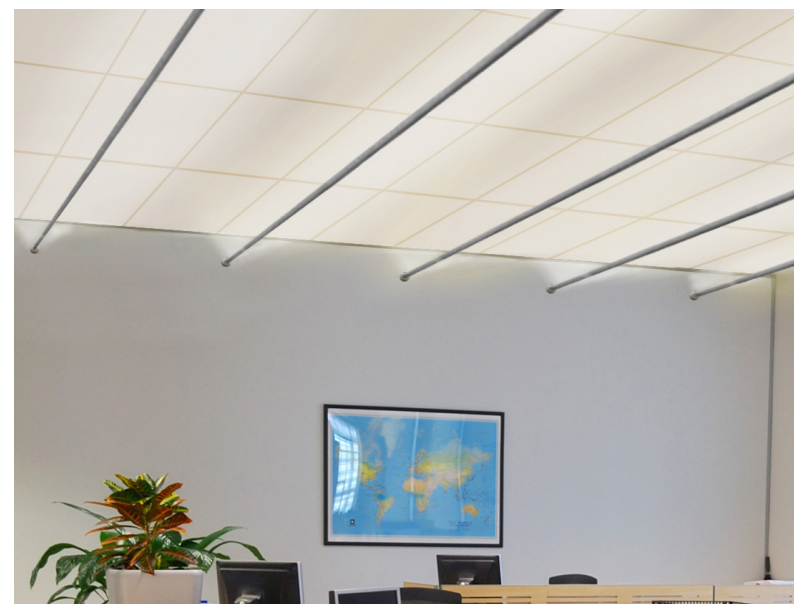
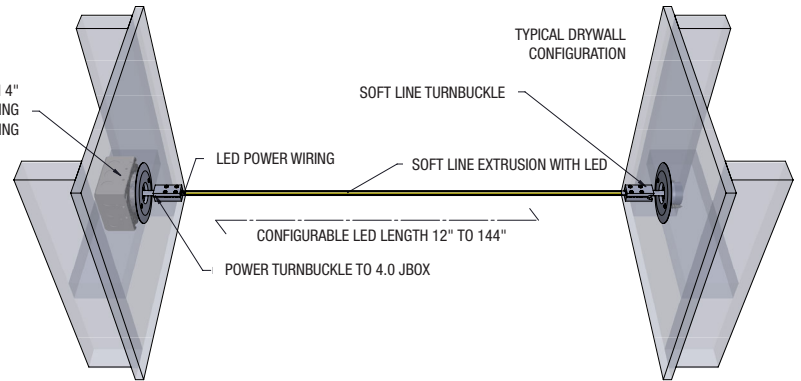

PROJECT	FIXTURE TYPE	DATE
---------	--------------	------

SOFT LINE INDIRECT LIGHTING SYSTEM

1.25" WIDE SUSPENDED LED LIGHTING SYSTEM, 24VDC REMOTE POWER SUPPLY

REV 10.06.20

Lamp Data: Lamp data for SLS Single Light

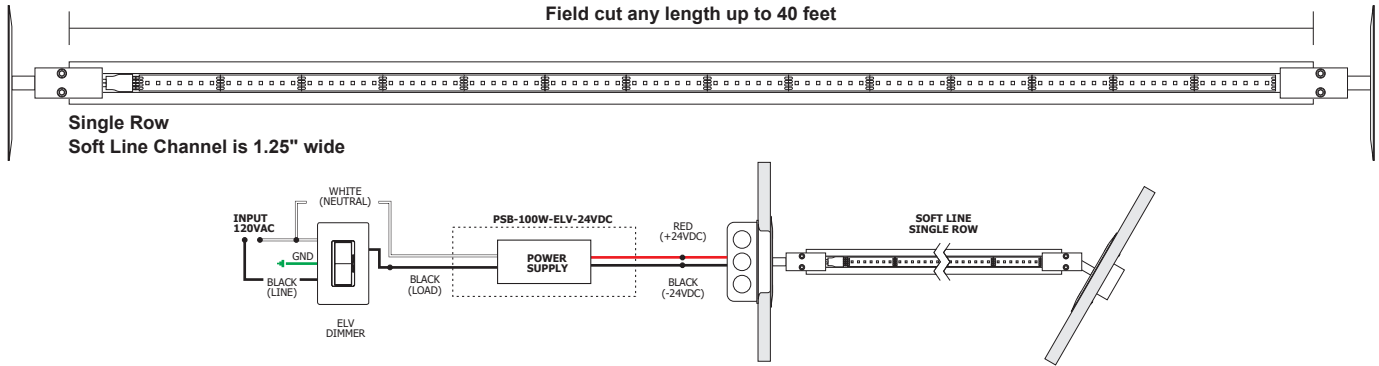

Lamp Data: Lamp data for SLD Dual Row Uplight (2.5 watt x 2 = 5 watts per ft)

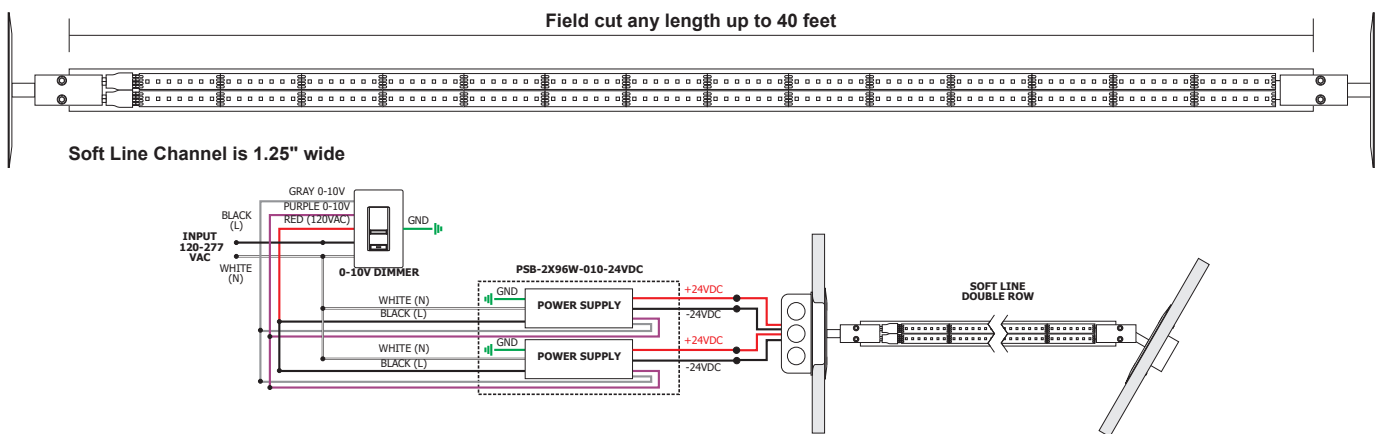

Lamp Data: Lamp data for SL Single Row Uplight

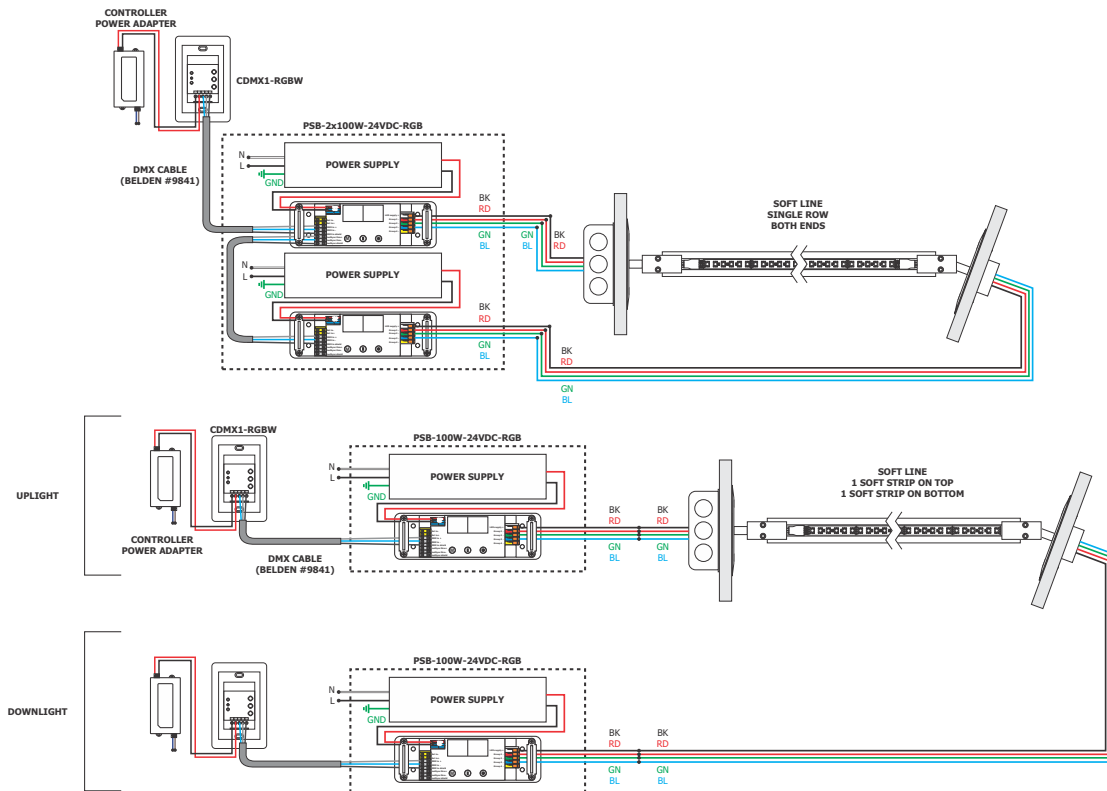

PROJECT	FIXTURE TYPE	DATE
---------	--------------	------

IN WALL MOUNTING OPTIONS

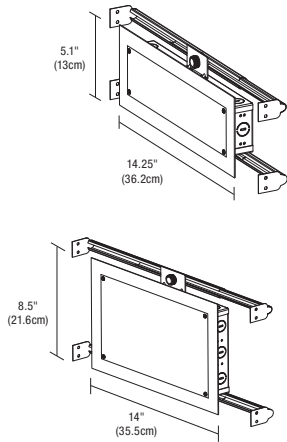

In-Wall Mounting Kit: Includes power supply, box cover and stud hangers for installing Junction Box in wall. Select "IW" in the options section of compatible power supply ordering codes if an In-Wall Mounting Kit is needed.

Ordering Codes 5.1 x 14.25 inch: PSB-40W-UNI-24VDC-IW
PSB-60W-UNI-24VDC-IW
PSB-96W-UNI-24VDC-IW

Ordering Codes 8.5 x 14.25 inch: PSB-2X40W-UNI-24VDC-IW
PSB-2X60W-UNI-24VDC-IW
PSB-2X96W-UNI-24VDC-IW

WIRING DIAGRAMS UNIVERSAL POWER SUPPLY

Application: Triac dimming for two power supplies, use for Static White, Dynamic/Tunable White 2000K-4000K

Dimming: Dimmable with Triac dimmer: Lutron: Skylark S2-L

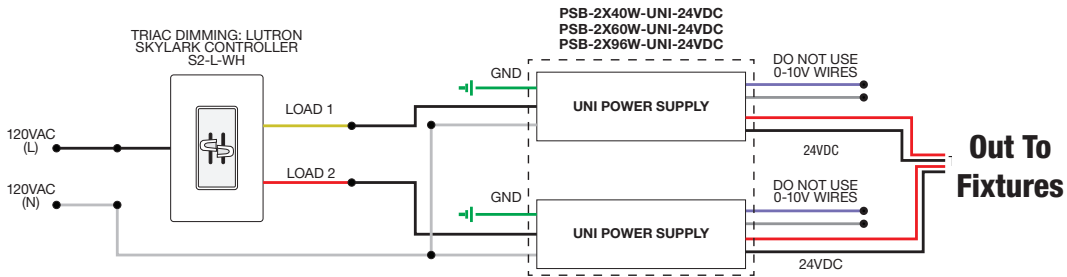

Application: ELV dimming for Static White and Warm Dim

Dimming: Dimmable with ELV dimmer: Legrand, Adorne ADTP703TU; Lutron: Diva DVELV-300P, Skylark SELV-300P, Maestro MAELV-600 and Radio Ra 2

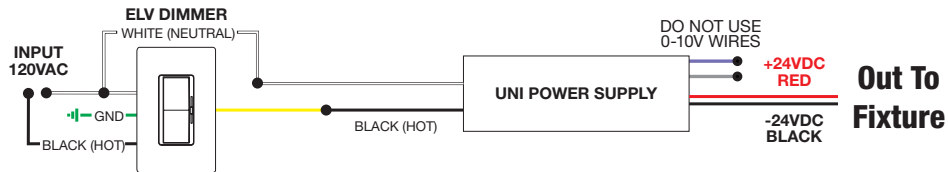

Application: 0-10V dimming for Static White

Dimming: Dimmable with 0-10V dimmer: Philips Sunrise: SR1200ZTUNV; Lutron Diva: DVTV-WH, DVSTV-WH; Lutron Nova T: NTSTV-DV-XX; Lutron Grafix EYE QS: QSGRJ-XP; Lutron Radio Ra2: RRD-10ND; Leviton: LEV40050; Leviton IP710-LFZ; Legrand: ADPD4FBL3P2W4

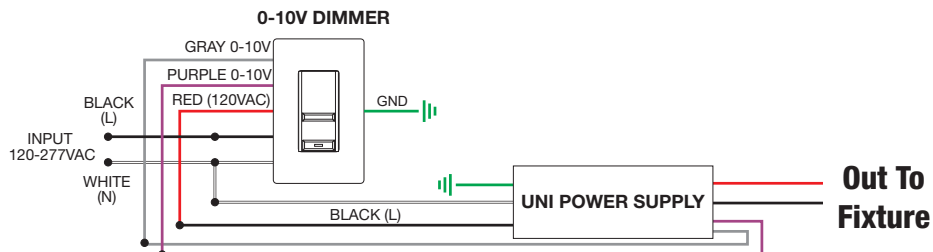

PROJECT	FIXTURE TYPE	DATE
---------	--------------	------

UNIVERSAL POWER SUPPLIES & RECOMMENDED DIMMERS†				
ORDERING CODE	PSB-2X40W-UNI-24VDC	PSB-2X60W-UNI-24VDC	PSB-2X96W-UNI-24VDC	PSB-4X96W-UNI-24VDC
SPECIFICATIONS				
MAXIMUM LOAD	2X40W	2X60W	2X96W	4X96W
INPUT VOLTAGE	120-277VAC	120-277VAC	120-277VAC	120-277VAC
OUTPUT VOLTAGE	24VDC	24VDC	24VDC	24VDC
DIMENSIONS	12.15" X 6.48" X 2.18"	12.15" X 6.48" X 2.18"	12.15" X 6.48" X 2.18"	17" X 13" X 3"
CLASSIFICATION	CLASS 2	CLASS 2	CLASS 2	CLASS 2
IN-WALL MOUNTING	PSB-2X40W-UNI-24VDC-IW	PSB-2X60W-UNI-24VDC-IW	PSB-2X96W-UNI-24VDC-IW	NA
ELV DIMMING & CONTROLS				
LUTRON DIVA: DVELV-300P	•	•	•	•
LUTRON SKYLARK: SELV-300P	•	•	•	•
LUTRON RADIO RA2: RRD-6NA	•	•	•	•
LUTRON MAESTRO: MAELV-600	•	•	•	•
LEGRAND ADORNE: ADTP-703TUM4	•	•	•	•
0-10 DIMMING & CONTROLS				
PHILIPS SUNRISE: SR1200ZTUNV	•	•	•	•
LUTRON DIVA: DVTW-WH, DVSTV-WH	•	•	•	•
LUTRON NOVA T: NTSTV-DV-XX	•	•	•	•
LUTRON GRAFIK EYE QS: QSGRJ-XP	•	•	•	•
LUTRON RADIO RA2: RRD-10ND	•	•	•	•
LEVITON: LEV40050	•	•	•	•
LEVITON IP710-LFZ	•	•	•	•
LEGRAND: ADPD4FBL3P2W4	•	•	•	•
TRIAC DIMMING & CONTROLS				
LUTRON SKYLARK: S2-L-WH	•	•	•	•
LUTRON DVLV-600P-WH	•	•	•	•
LUTRON DVLV-603P-WH	•	•	•	•
LUTRON MALV-600-WH	•	•	•	•
LUTRON MALV-1000-WH	•	•	•	•
LUTRON MA-R-XX	•	•	•	•

- Flicker free dimming
- Aluminum casing for optimal heat dissipation
- Isolated output power per NEC and UL safety requirements
- UL & ETL recognized/ listed, meets UL 8750, 1310 requirements
- Auto-reset; short circuit, overload and thermal protection
- Class 2 power supply
- Efficient, High power factor > 0.90

- The Solid State Constant Voltage Uni-Power Supply is compatible with most commercially available Dimmers:
 - Triac Dimmer: (Forward Phase) Typically used for the dimming of Incandescent and Low Voltage Magnetic Transformers
 - ELV Dimmer: (Reverse Phase) Dimming of Electronic Low Voltage Transformers and Power Supply's used for LED lighting
 - 0-10 Dimmer: Dims the Low Voltage side of a 0-10 volt power supply commonly used in large scale lighting or commercial applications.
- The Uni-Power Supply is recommended with any Siemens/Murray brand of arc fault breaker to overcome the issues with tripping the breakers with an ELV LED Low Voltage Drivers.

MAXIMUM LENGTH

POWER SUPPLY	5 WATTS	10 WATTS
PSB-2X40W-UNI-24VDC	8 FEET	4 FEET
PSB-2X60W-UNI-24VDC	12 FEET	6 FEET
PSB-2X96W-UNI-24VDC	20 FEET	10 FEET

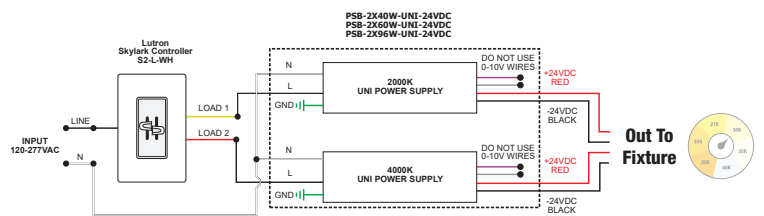

Configuration 1
S2-L-WH (TRIAC) Single Pole Dimming with Dual Universal Power Supplies

IN WALL MOUNTING OPTIONS

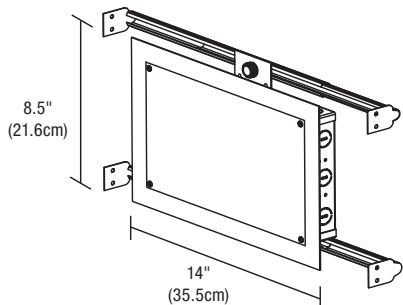

In-Wall Mounting Kit: Includes power supply, box cover and stud hangers for installing Junction Box in wall. Select "IW" in the options section of compatible power supply ordering codes if an In-Wall Mounting Kit is needed.

Ordering Codes 8.5 x 14.25 inch: PSB-2X40W-UNI-24VDC-IW, PSB-2X60W-UNI-24VDC-IW, PSB-2X96W-UNI-24VDC-IW

PROJECT	FIXTURE TYPE	DATE
---------	--------------	------

DYNAMIC/TUNABLE WHITE CONTROLLER AND POWER SUPPLIES

24VDC INDOOR CONSTANT VOLTAGE POWER SUPPLIES WITH DMX DRIVERS

REV 10.06.20

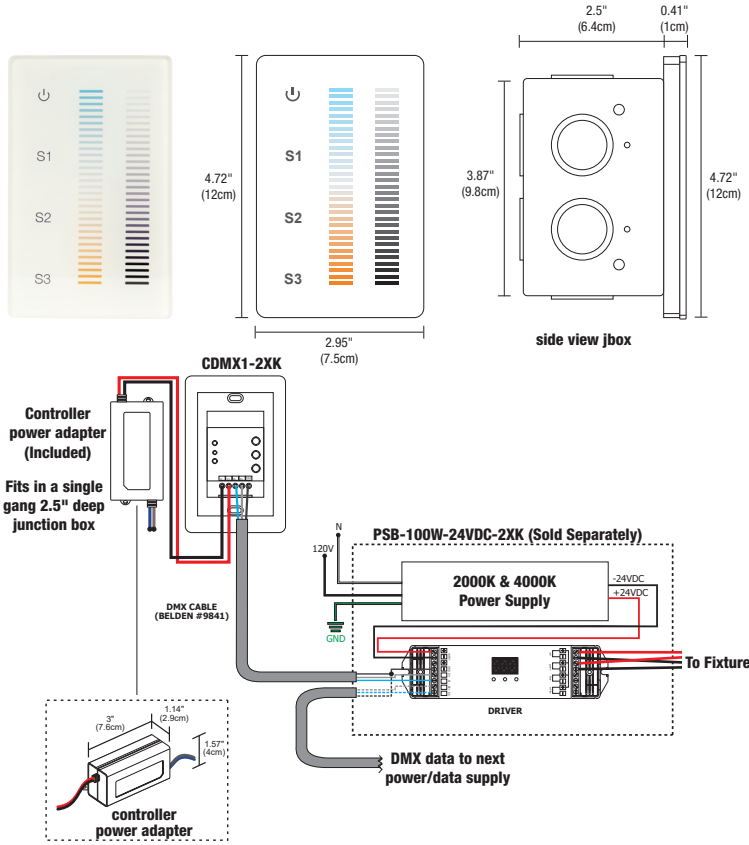

DESCRIPTION:

The Dynamic/Tunable White (**2K4K**) Touch Controller offers fast and accurate Color Temperature adjustment and the ability to regulate the Brightness Independently. The modern Glass faceplate features illuminated indicators, and a back-lit night light that softly illuminates the controller when powered off. Designed for Dynamic/Tunable White, and dual-color LED installations within a single zone. The two Vertical Touch sliders are precise and sensitive, allowing you to fine-tune your perfect Color Temperature at any point between **2000K (Sunset) to 4000K (Cool White)** while selecting over **250 levels** of Brightness in a smooth, uninterrupted transition. Create Thousands of Dynamic White Color Combinations while maintaining even Brightness and overall saturation. Easily save three pre-set scenes for different times of the day. Support health, performance, and general well-being using Human-Centric lighting by fine-tuning the biological effects that light has on the circadian cycle using the latest in LED technology. Includes a power adapter that fits behind the controller within a standard junction box and fits inside a standard single-gang receptacle (not for use in a multi-gang box). Use with an insulated, 24 AWG stranded, tinned copper wire (Belden #9841). Power Supplies are Sold Separately. Includes a 5 year pro-rated warranty.

APPLICATIONS:

Indoor

OUTPUT SIGNAL:

USITT DMX 512 (1990)

INSTALLATION:

Fits in a single gang 2.5 inch deep junction box. Not compatible with multi-gang boxes.

LABELS:

ROHS, FCC, Damp Location, ETL/UL

POWER INPUT:

120-240VAC

Product	Type	Finish
CDMX1	2XK	WH
CDMX1 DMX Single Zone Touch Controller	2XK 2 X Kelvin	WH White

DYNAMIC COLOR CHANGING (DMX) POWER SUPPLIES & RECOMMENDED CONTROLLERS*

ORDERING CODE	PSB-100W-24VDC-2XK	PSB-2X100W-24VDC-2XK	PSB-3X100W-24VDC-2XK	PSB-4X100W-24VDC-2XK
SPECIFICATIONS				
MAXIMUM LOAD OF LED STRIP LENGTH	100W 5 WATTS - 20FT MAX. 10 WATTS - 10FT MAX.	2X100W 5 WATTS 2 X 20FT MAX. 10 WATTS - 2 X 10FT MAX.	3X100W 5 WATTS 3 X 20FT MAX. 10 WATTS - 3 X 10FT MAX.	4X100W 5 WATTS 4 X 20FT MAX. 10 WATTS - 4 X 10FT MAX.
INPUT VOLTAGE	120-277VAC	120-277VAC	120-277VAC	120-277VAC
OUTPUT VOLTAGE	24VDC	24VDC	24VDC	24VDC
DIMENSIONS	12.4" X 6.48" X 2.18"	14" X 10" X 3"	17" X 10" X 3"	17" X 10" X 3"
CLASSIFICATION	CLASS 2	CLASS 2	CLASS 2	CLASS 2
IN-WALL MOUNTING	PSB-100W-24VDC-2XK-IW	NA	NA	NA
DMX DYNAMIC/TUNABLE WHITE DIMMING & CONTROLS				
TUNABLE WHITE TOUCH CONTROLLER (CDMX1-2XK)	•	•	•	•

- Flicker free dimming
- Aluminum casing for optimal heat dissipation
- Isolated output power per NEC and UL safety requirements
- UL & ETL recognized/ listed, meets UL 8750, 1310 requirements

- Auto-reset; short circuit, overload and thermal protection
- Class 2 power supply
- Efficient, High power factor > 0.90

IN WALL MOUNTING OPTIONS

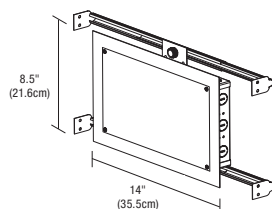

8.5 x 14 inch In-Wall Mounting Kit: Includes power supply, box cover and stud hangers for installing Junction Box in wall. Select "IW" in the options section of compatible power supply ordering codes if an In-Wall Mounting Kit is needed.

Ordering Codes: PSB-100W-24VDC-2XK-IW

PROJECT	FIXTURE TYPE	DATE
---------	--------------	------

LUTRON HI-LUME® PREMIER .1% ECOSYSTEM®†			
ORDERING CODES	L3D0-96W24V-U	2-WIRE ECOSYSTEM LTEA4U1UKL-CV240	3-WIRE ECOSYSTEM L3DA4U1UKL-CV240
SPECIFICATIONS			
MAXIMUM LOAD	96W	5W-40W	5W-40W
INPUT VOLTAGE	120-277VAC	120-277VAC	120-277VAC
OUTPUT VOLTAGE	24VDC	24VDC	24VDC
DIMENSIONS	10.5" X 5.5" X 2"	4" X 4.89" X 2.62"	4" X 4.89" X 2.62"
CLASSIFICATION	CLASS 2	CLASS 2	CLASS 2
DIMMING AND CONTROLS			
RADIO RA2	•	•	•
HOMEWORKS QS	•	•	•
PHPM-3F-120	•	•	•
PHPM-3F-DV	•	•	•
BCI-0-10	•	•	•

†24K - 57K color temperatures are compatible with 0-10V, ELV, and Lutron Hi-lume® Power Supplies. Warm Dim (27D, 30D) color temperatures are only compatible with ELV power supplies.

2-Wire EcoSystem Wiring Diagram

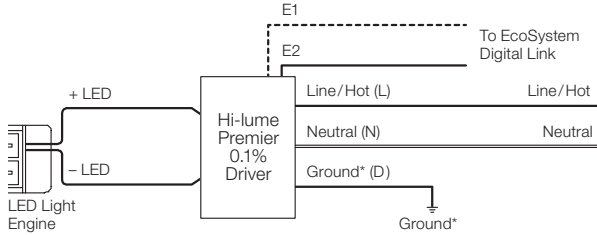

LTEA4U1UKL-CV240

3-Wire Wiring Diagram

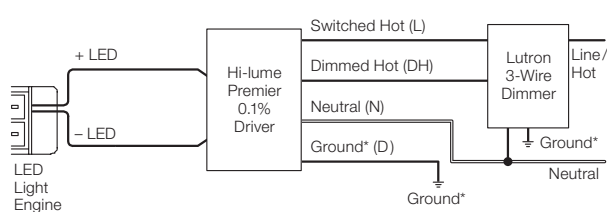

L3DA4U1UKL-CV240

PROJECT		FIXTURE TYPE		DATE	
---------	--	--------------	--	------	--

LUTRON HI-LUME® PREMIER .1% ECOSYSTEM®†			
ORDERING CODES	L3D0-96W24V-U	2-WIRE ECOSYSTEM LTEA4U1UKL-CV240	3-WIRE ECOSYSTEM L3DA4U1UKL-CV240
SPECIFICATIONS			
MAXIMUM LOAD	96W	5W-40W	5W-40W
INPUT VOLTAGE	120-277VAC	120-277VAC	120-277VAC
OUTPUT VOLTAGE	24VDC	24VDC	24VDC
DIMENSIONS	10.5" X 5.5" X 2"	4" X 4.89" X 2.62"	4" X 4.89" X 2.62"
CLASSIFICATION	CLASS 2	CLASS 2	CLASS 2
DIMMING AND CONTROLS			
RADIO RA2	•	•	•
HOMEWORKS QS	•	•	•
PHPM-3F-120	•	•	•
PHPM-3F-DV	•	•	•
BCI-0-10	•	•	•

†24K - 57K color temperatures are compatible with 0-10V, ELV, and Lutron Hi-Lume® Power Supplies. Warm Dim (27D, 30D) color temperatures are only compatible with ELV power supplies.

*Tunable White (2K4K) Color Temperature is compatible with 0-10V, ELV, DMX, and Lutron Hi-Lume® Power Supplies. Dynamic Color (RGB, RGB+W) and Static Color (Amber, Blue, Green, or Red) are compatible with DMX Power Supplies.

**Tunable White (2K4K) uses one or two power supplies, dependent on the controller or dimmer(s) used.

Lutron Hi-Lume® can be used in both single or dual power formats, dependent on the controller or dimmer(s). Specify amount of Power Supplies based on this.

WIRING DIAGRAM: DMX Control with Lutron Grafik Eye Control Unit

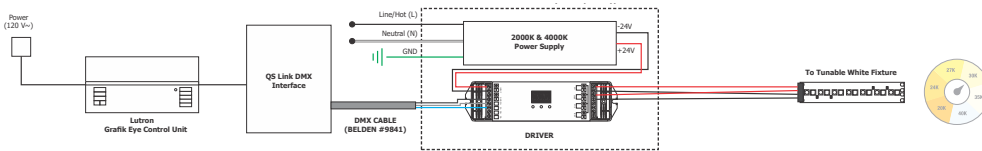

WIRING DIAGRAM: Line Voltage Dimming with Lutron Grafik Eye Control Unit

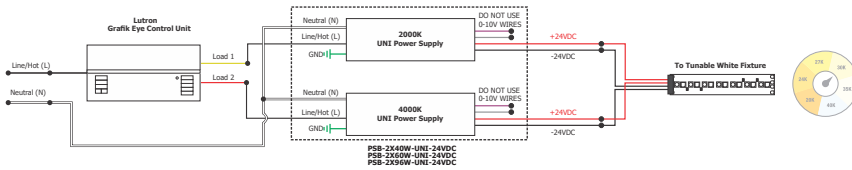

WIRING DIAGRAM: 0-10V Dimming with Lutron Grafik Eye Control Unit or Wall box controller

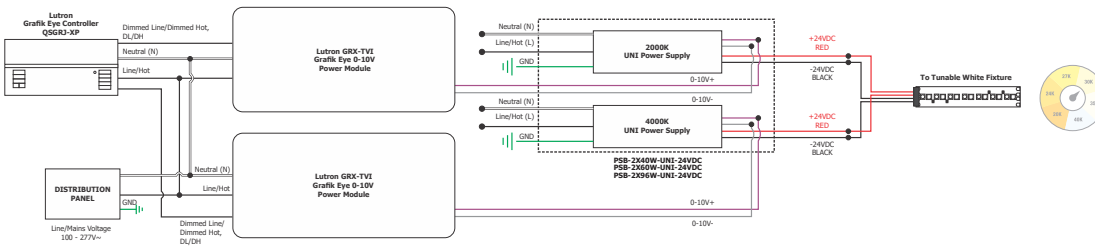

WIRING DIAGRAM: 2-Wire EcoSystem Panel

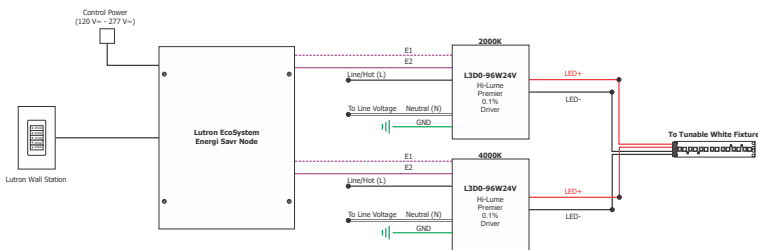

WIRING DIAGRAM: 3-Wire EcoSystem Wall Box

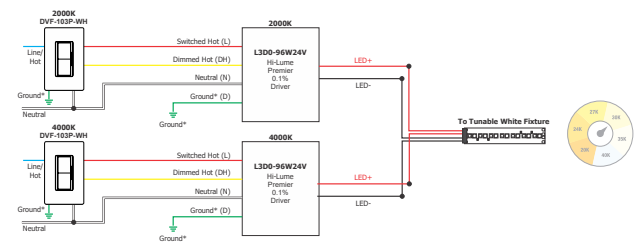

PROJECT	FIXTURE TYPE	DATE
---------	--------------	------

DMX SINGLE ZONE RGB & RGB+W

TOUCH CONTROLLER

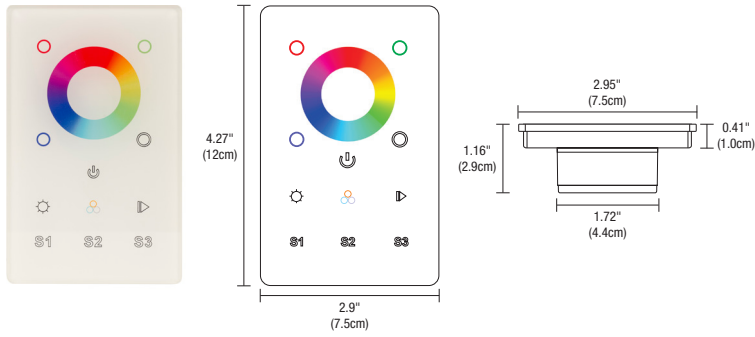

Description:

Full touch controller offers fast and accurate color tone adjustment and independent brightness control. The 1 zone controller can adjust RGB and RGBW LEDs smoothly and accurately. Independent smooth dimming of each channel enables the controller to achieve millions of colors. For indoor applications only, and includes a Power Adapter to operate the controller.

Applications:
Indoor

Power Input:
120-277VAC

Installation:
Fits in a single gang 2.5 inch deep junction box, not to be used with a multi gang box

Output Signal:
USITT DMX 512 (1990)

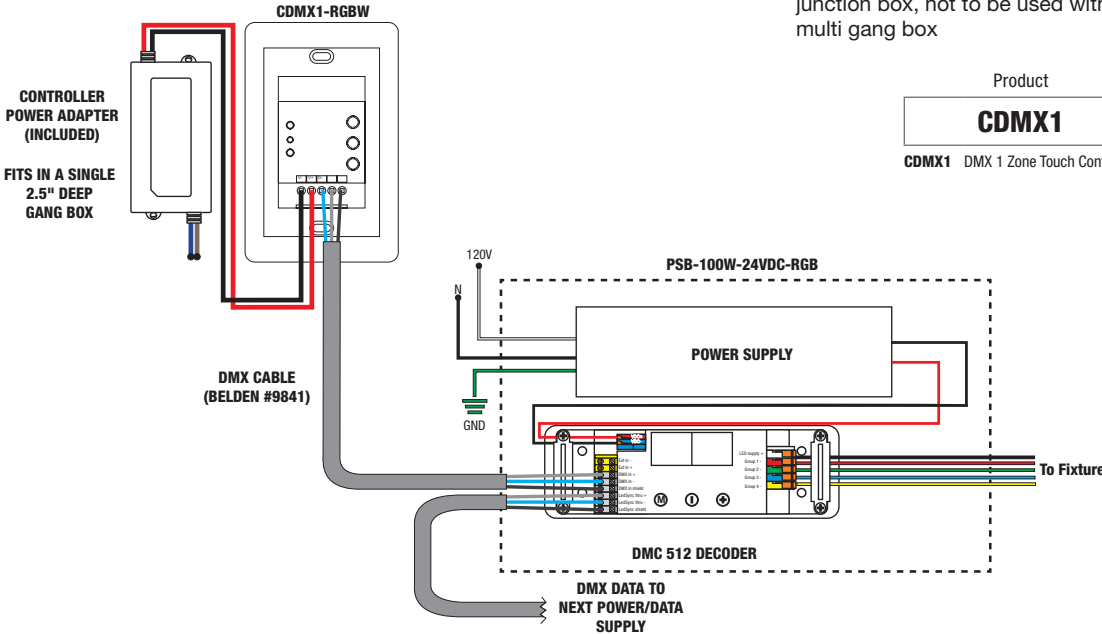

Product	Type	Finish
CDMX1	RGBW	WH
CDMX1 DMX 1 Zone Touch Controller	RGBW RGB & RGBW	WH White

DYNAMIC COLOR CHANGING (DMX) POWER SUPPLIES & RECOMMENDED CONTROLLERS				
ORDERING CODE	PSB-100W-24VDC-RGB	PSB-2X100W-24VDC-RGB	PSB-3X100W-24VDC-RGB	PSB-4X100W-24VDC-RGB
SPECIFICATIONS				
MAXIMUM LOAD	100W	2X100W	3X100W	4X100W
INPUT VOLTAGE	120-277VAC	120-277VAC	120-277VAC	120-277VAC
OUTPUT VOLTAGE	24VDC	24VDC	24VDC	24VDC
DIMENSIONS	12.14" X 6.48" X 2.18"	14" X 10" X 3"	17" X 13" X 3"	17" X 13" X 3"
CLASSIFICATION	CLASS 2	CLASS 2	CLASS 2	CLASS 2
IN-WALL MOUNTING	PSB-100W-24VDC-RGB-IW	N/A	N/A	N/A
DIMMING & CONTROLS				
TOUCH SCREEN CONTROLLER (CTP)	•	•	•	•
COLOR DIAL CONTROLLER (CDP)	•	•	•	•
DMX 1 ZONE RGBW TOUCH CONTROLLER (CDMX1-RGBW)	•	•	•	•

Classification: UL2108 - * 24VDC over 100 Watts, wires must be in conduit from Remote Power Supply to J-box.

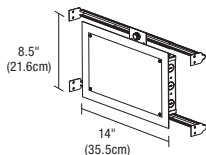

8.5" X 14" IN-WALL MOUNTING KIT

Includes Power Supply, Box Cover, and Stud Hangers for installing Junction Box in wall. Select "IW" in the options section of compatible Power Supply ordering codes if an In-Wall Mounting Kit is needed.

ORDERING CODES: PSB-100W-24VDC-RGB-IW

PROJECT	FIXTURE TYPE	DATE
---------	--------------	------



CTP

COLOR TOUCH SCREEN CONTROLLER WITH POWER ADAPTER



REV 10.06.20

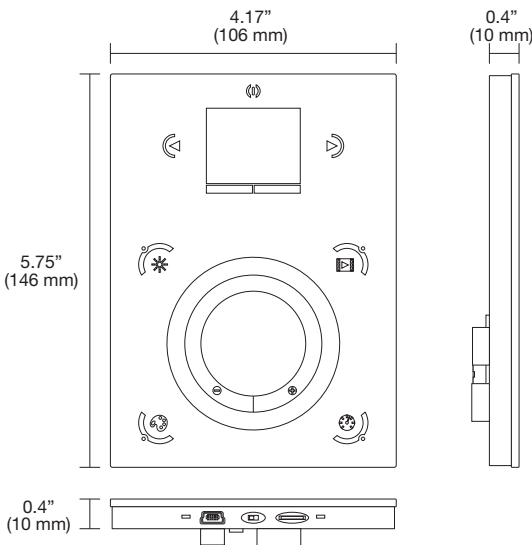
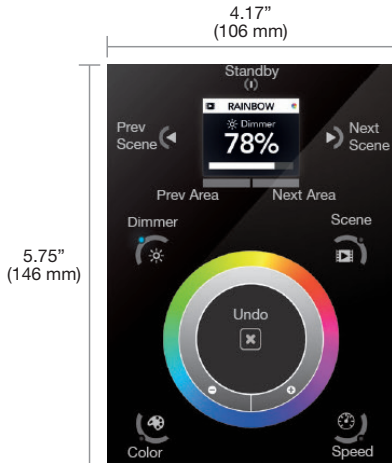

DESCRIPTION

Full touch controller offers fast and accurate color tone adjustment and independent brightness control. The 10 zone controller can adjust RGB and RGBW LEDs smoothly and accurately. Independent smooth dimming of each channel enables the controller to achieve millions of colors. For indoor applications only, and includes a Power Adapter to operate the controller.

FEATURES AND BENEFITS

KEY FEATURES:

- Sleek glass design which sits 11mm from the wall
- Graphical color display to show selected environment
- Color/dimmer/speed palette
- Color temperature mixing
- Touch sensitive buttons. No mechanical parts
- Touch sensitive wheel allows for accurate color selection
- Multi-zone microSD memory
- Multi-room control with 500 scenes, 10 zones
- 1024 DMX channels. Control 340 RGB fixtures
- USB & Ethernet connectivity for programming and control
- RS232, Dry Contact Ports and an Infra Red input port
- Clock and calendar with Sunrise/Sunset triggering
- Network communication. Control lighting remotely
- Catalog of designs including black and white glass
- OEM customization of the color palette and logo
- Windows/Mac software to set dynamic colors/effects
- iPhone/iPad/Android remote and programming apps

APPLICATIONS

Indoor

POWER ADAPTER

9VDC 0.65A (included)

POWER INPUT

7VDC 0.6A

OUTPUT SIGNAL

DMX512 1,024 channels total

INPUT SIGNAL

Universal IR receiver (Sold Separately), RS232, Contact Closure, Live Computer Link, DMX512, WiFi

CONNECTIONS

USB, Ethernet, RS232, Clock, 8 dry contact ports, open drain output

MEMORY

microSD (32GB Max)

COMPUTER AND MOBILE DEVICE REQUIREMENTS

IPHONE/IPAD/ANDROID:

The controller may be used with any of the following apps: DMX Lightpad 3, Easy Remote and Arcolis may be downloaded from App Store or Google Play.

ESA PRO SOFTWARE (WINDOWS ONLY, TIMELINE AND MULTI-ZONE):

Windows ME, XP, Vista, 7 or 8 (32 bits and US 2.0, computer connection required for initial setup only.)

ESA2 SOFTWARE (WINDOWS/MAC, SINGLE ZONE):

Windows ME, XP, Vista, 7 or 8

Mac OS X 10.7 (Lion), 10.8 (Mountain lion), 10.9 (Mavericks), 10.10 (Yosemite)

Product



CTP Color Touch Screen Controller with Power Adapter

PROJECT		FIXTURE TYPE		DATE	
---------	--	--------------	--	------	--



CTP

COLOR TOUCH SCREEN CONTROLLER WITH POWER ADAPTER

RGB Wiring Diagram

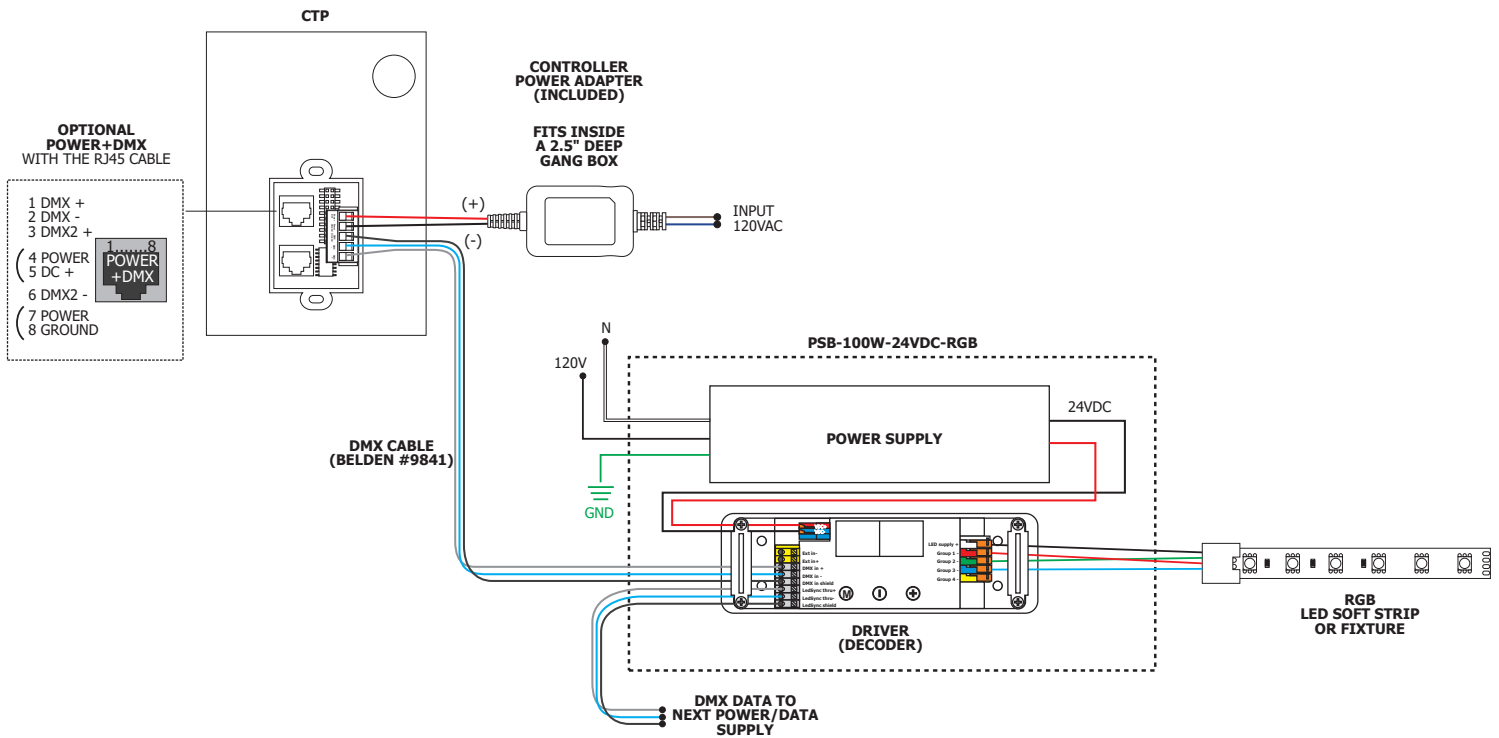

RGBW Wiring Diagram

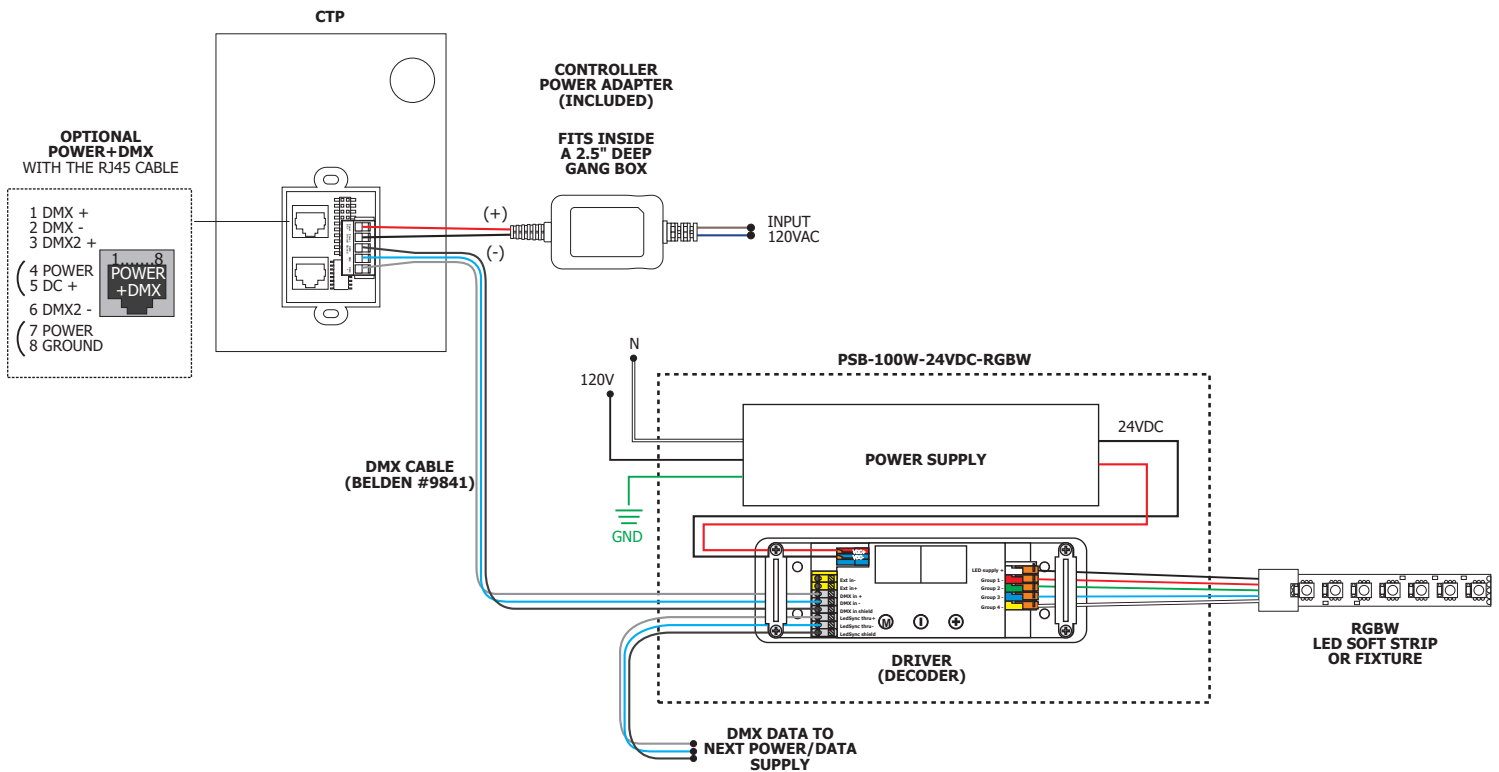

PROJECT	FIXTURE TYPE	DATE
---------	--------------	------



CTP

COLOR TOUCH SCREEN CONTROLLER WITH POWER ADAPTER

Tunable White Wiring Diagram

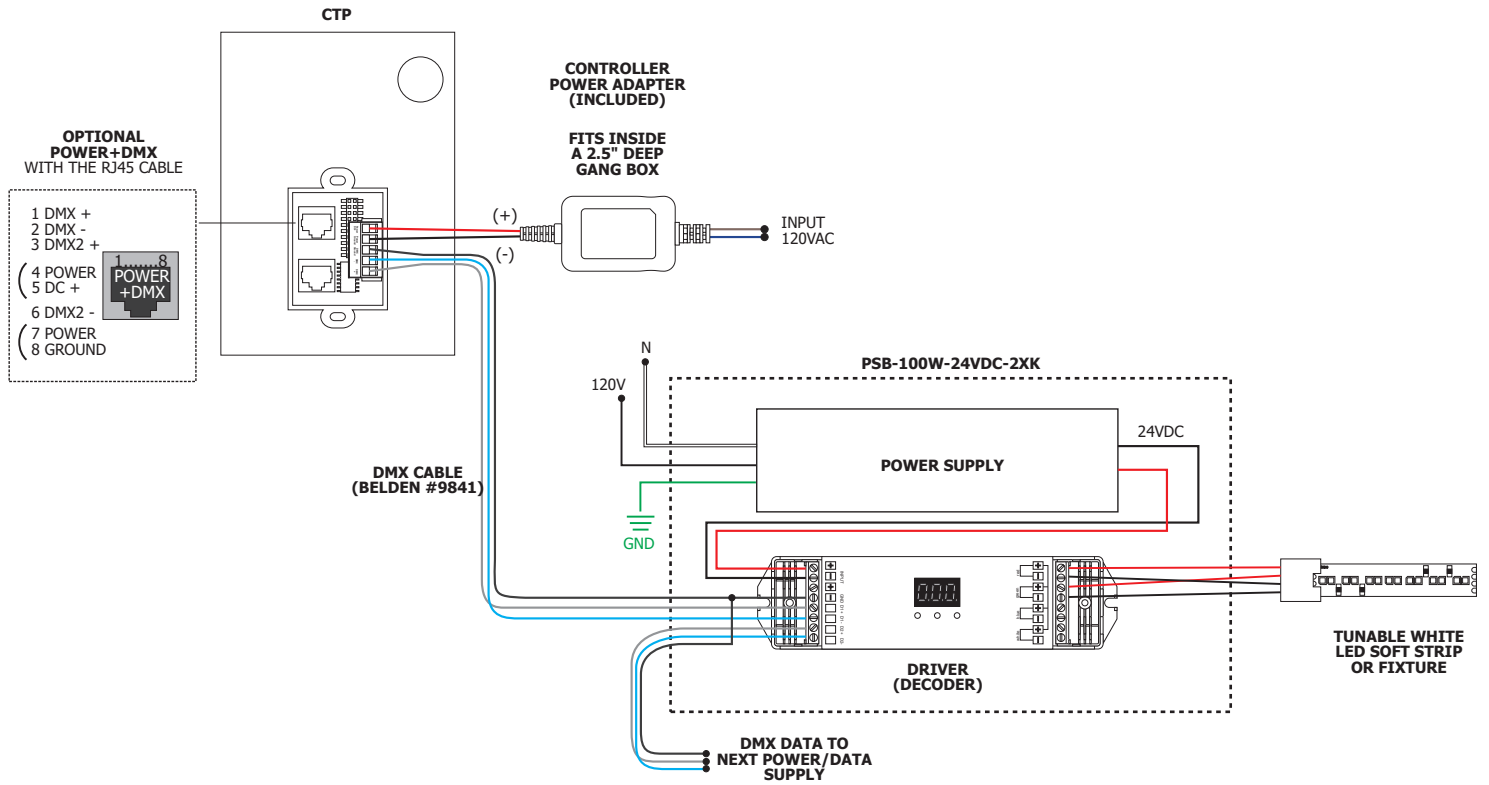

PROJECT		FIXTURE TYPE		DATE	
---------	--	--------------	--	------	--