



Description: TruLine .5A BIY (Build-It-Yourself) allows for creating more complex configurations using Pre-Formed Components for simplifying the installation process. The versatile 24VDC linear plaster-in LED system, creates glare-free, indoor architectural lighting. The system recesses into 5/8 inch thick drywall without joist modification. May be secured to studs that are spaced 13 – 24 inches apart, or between studs with mounting clips provided. TruLine 1A is sold in 1 foot increments up to 40 feet (2WDC, white LEDs only), 20 feet (5WDC, white, 2K4K or RGB LEDs) or 16 feet (6WDC, RGBW) and may be field-cut to any length. Several color temperature options are available, including 22K – 57K (ELV/010), Warm Dim (ELV), Tunable White (ELV/010/DMX), RGB and RGBW (DMX). High CRI commercial-grade white or dynamic color-changing LED Soft Strip projects a clean line of light. Coordinate installation with electrician and drywall contractors. Includes a 5-year pro-rated warranty.

Applications: Indoor damp or dry locations only. General illumination and architectural accent for kitchens, offices, hospitality, retail, residences, libraries, hallways, and bath/vanity.

Lamp: The average LED Life is 50,000 hours

Watts per Foot	Lumens		85+CRI 22K, 35K, 40K, 57K	90+CRI 2K4K	92+CRI 27D, 30D	95+CRI 27K, 30K	RGB	RGBW
	per Watt	per Foot						
2WDC (2.5WDC)	52	169	•			•		
5WDC	50	244	•	•	•	•	•	
6WDC	N/A	N/A						•

Lumen values are based on the 3000K LED test.

Remote Power Supplies*, Dimmers & Controls (Sold Separately):

- Electronic Low Voltage Dimming (ELV)
- 0-10 Volt Dimming (0-10V)
- Dynamic Color Changing (DMX)

*In-Wall Mounting Kits available for select power supplies

Picture Frame Installation Design Note:

TruLine .5A can be installed on a single surface (like a wall or ceiling), or on multiple planes that join runs from wall to ceiling, or from one wall to an adjacent wall. Add BIY Pre-Formed Components to create desired Picture Frame Installations.

Picture Frame Miter is the style of installation in which the electrician may create 90-degree turns on a single surface with L-Picture Frame Channel Connectors (TL.5A-L) and/or L-Picture Frame Power Channel Connectors (TL.5A-LP). The LED Soft Strip is installed on the side of channel and bends within L-shaped channel connectors to create continuous illumination on a wall or a ceiling.

Room Wrapping Design Note: TruLine can be installed on a single surface (like a wall or ceiling), or on multiple planes that join runs from wall to ceiling, or from one wall to an adjacent wall. Add BIY Pre-Formed Components to create desired Room Wrapping Installations.

Room Wrapping is the style of installation in which the electrician may create 90-degree angles with Inside Corner Channel Connectors (TL.5A-IC) and/or Outside Corner Channel Connectors (TL.5A-OC). The LED Soft Strip is installed flat in the back wall of the channel; and bend within inside or outside corners for seamless light across surfaces.

Pre-Formed Components: 8 Foot Channel and Lens, End Feed Power Channel Connector, Center Feed Power Channel Connector, L-Picture Frame Power Channel Connector, Junction Box, Outside Corner Channel Connector, Inside Corner Channel Connector, Channel Joiners, Take-Up Box, Channel Solderless Push & Light Straight Joiner Connector

A Division of PureEdge Lighting 1718 W. Fullerton Chicago, IL 60614 • Ph: 773.770.1196 • Fax: 773.883.6128 • www.purelighting.com

For custom design and layout assistance, send drawings to design@PureEdgeLighting.com

COMPANY		FIXTURE TYPE		DATE	
PROJECT		APPROVED BY			

Product specification subject to change without notification. REV.06.02.17



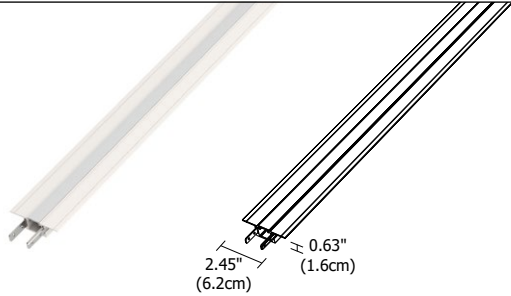

8 Foot Channel and Lens: 8-foot plaster-in channel with lens. LED Soft Strip (not included) may be installed flat or on side of the channel. Allows for the creation of Truline .5A BIY systems. May be field-cut to any length, includes Channel Joiners.

System	Component	Size
TL.5A	-	CHLN - 8FT
TL.5A	TruLine .5A	CHLN Channel and Lens 8FT 8 Feet

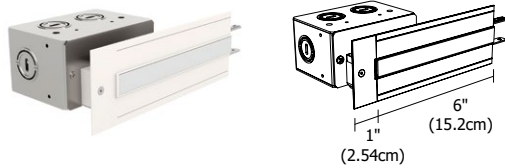

End Feed Power Channel Connector: Allows 24VDC power to be fed from the end of the channel. LED Soft Strip (not included) may be installed flat or on side of the channel. Includes lens, Channel Joiners, Junction Box, Adjustable Mounting Bars, and Channel Solderless Snap & Light Power Connectors.

System	Component	Options
TL.5A	-	EP - White & RGB (Leave Blank)
TL.5A	TruLine .5A	EP End Feed Power Channel Connector RGBW Red, Green, Blue, and 2000K White

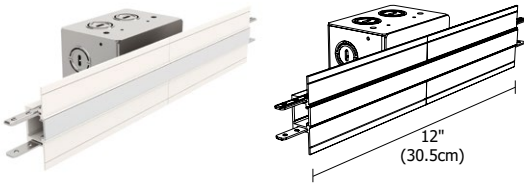

Center Feed Power Channel Connector: Allows 24VDC power to be fed from the center of the channel. LED Soft Strip (not included) may be installed flat or on side of the channel. Includes lens, Channel Joiners, Junction Box, Adjustable Mounting Bars, and Channel Solderless Snap & Light Power Connectors.

System	Component	Options
TL.5A	-	CFP - White & RGB (Leave Blank)
TL.5A	TruLine .5A	CFP Center Feed Power Channel Connector RGBW Red, Green, Blue, and 2000K White

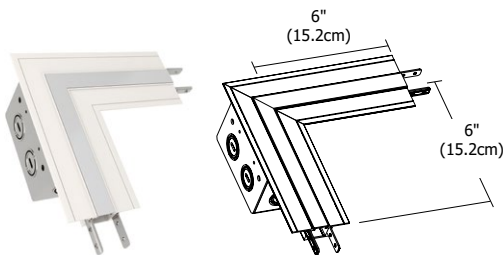

L-Picture Frame Power Channel Connector: Allows 24VDC power to be fed from corners for 90-degree turns (with power) in Picture Frame Installations. LED Soft Strip (not included) bends on the side within connector to create continuous illumination on a wall or ceiling. LP2 version powers 2 separate LED Soft Strip sections. LED Soft Strip is installed on the side of channel. Includes lens, Channel Joiners, Junction Box, Adjustable Mounting Bars, and Channel Solderless Snap & Light Power Connectors.

System	Component	Options
TL.5A	-	LP - White & RGB (Leave Blank)
TL.5A	TruLine .5A	LP L-Picture Frame Power Channel Connector LP2 L-Picture Frame Dual Feed Power Channel Connector RGBW Red, Green, Blue, and 2000K White

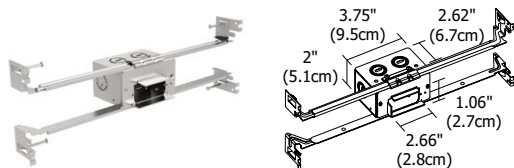

Junction Box: Included with End Feed Power Channel Connector, Center Feed Power Channel Connector, and L-Picture Frame Power Channel Connector. Mounts behind drywall with Adjustable Mounting Bars. Low voltage 24VDC wires from remote power supply connect to LED wires inside box. Junction Box opening is covered by channel. Required to rough-in electrical before TruLine installation.

System	Size	Component
TL.5A	-	1RE - JBOX
TL.5A	TruLine .5A	1RE 1" Rectangle JBOX Junction Box

COMPANY		FIXTURE TYPE		DATE	
PROJECT		APPROVED BY			



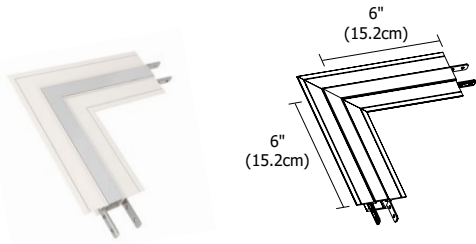

L-Picture Frame Channel Connector: Allows for Picture Frame Installations on 90 degree turns. LED Soft Strip (not included) bends on the side within connector to create continuous illumination on a wall or ceiling. LED Soft Strip is installed on the side of the channel. Includes lens and Channel Joiners.

System	-	Component
TL.5A	-	L
TL.5A TruLine .5A		L L-Picture Frame Channel Connector

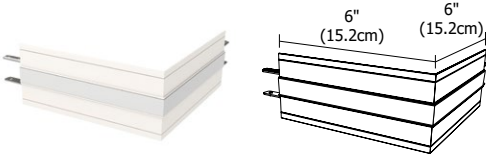

Outside Corner Channel Connector: Allows for Room Wrapping Installations on 90 degree outside corners. LED Soft Strip (not included) bends flat within outside corners for seamless light across surfaces. For use from wall to ceiling or from one wall to an adjacent wall. Includes lens and Channel Joiners.

System	-	Component
TL.5A	-	OC
TL.5A TruLine .5A		OC Outside Corner Channel Connector

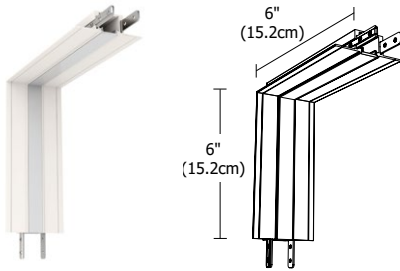

Inside Corner Channel Connector: Allows for Room Wrapping Installations on 90 degree inside corners. Includes lens and Channel Joiners. LED Soft Strip (not included) bends flat within inside corners for seamless light across surfaces. For use from wall to ceiling or from one wall to an adjacent wall.

System	-	Component
TL.5A	-	IC
TL.5A TruLine .5A		IC Inside Corner Channel Connector

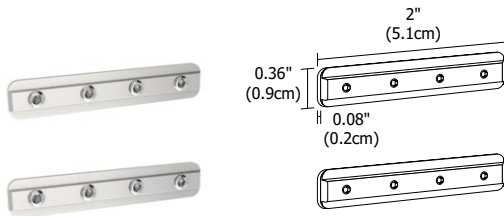

Channel Joiners: Included with straight channel, channel connectors, power feeds and Take-Up Box. Channel Joiners ship as a pair to connect two channels together. Additional channel joiners may be necessary based on lighting design.

Product	-	Type
LCR	-	SC
LCR TruLine Channel Joiner		SC Straight Connector

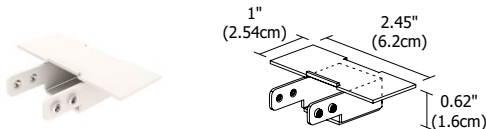

Take-Up Box: Prevents dark spots at end of run by tucking excess LED Soft Strip safely behind wall. Includes Channel Joiners.

System	-	Component
TL.5A	-	TBOX
TL.5A TruLine .5A		TBOX Take-Up Box

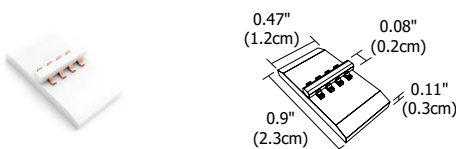

Soft Strip Solderless Snap & Light Straight Joiner: Sold separately, and joins 2 sections of LED Soft Strip in the channel. Used when replacing a section of LED Soft Strip.

Product	-	Type
CH	-	SLC
CH Channel		SLC Snap & Light Straight Joiner, 4 wire (27K-57K, 27D, 30D, and 2K4K)
		SLC-RGBW Snap & Light Straight Joiner, 5 wire (RGB+W)

COMPANY		FIXTURE TYPE		DATE	
PROJECT		APPROVED BY			



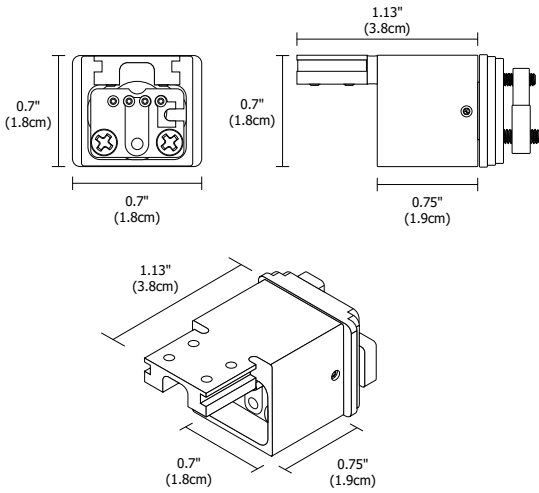

In and Out Connector to ZIP Modular Ceiling and Suspension: TruLine .5A In and Out Connector joins the end of Edge Lighting's Zip Modular Ceiling or Suspension systems to TruLine .5A recessed extrusion.

System	Type	Finish
TL.5A-IO-ZIP	- CA	- SN
TL.5A-IO-ZIP	TruLine .5A to Zip Modular Ceiling and Suspension	CA End Cap SN Satin Nickel

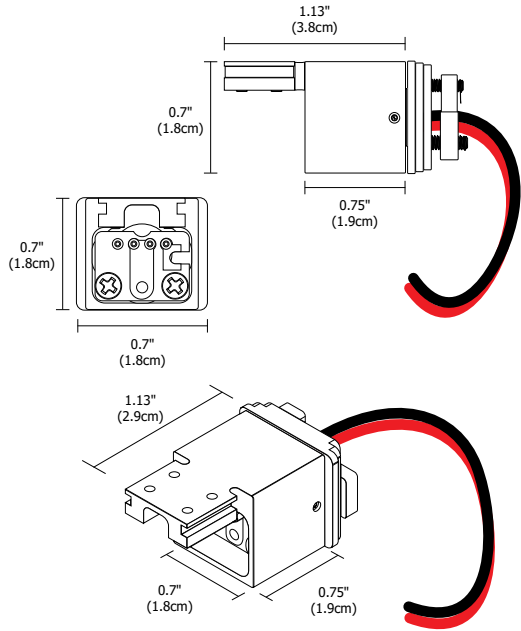

In and Out Power Connector to ZIP Modular Ceiling and Suspension: TruLine .5A In and Out Connector joins and provides power from the end of Edge Lighting's Zip Modular Ceiling or Suspension systems to TruLine .5A recessed extrusion.

System	Type	Finish
TL.5A-IO-ZIP	- CAP	- SN
TL.5A-IO-ZIP	TruLine .5A to Zip Modular Ceiling and Suspension	CAP End Cap Power SN Satin Nickel



COMPANY		FIXTURE TYPE		DATE	
PROJECT		APPROVED BY			



LED SOFT STRIP

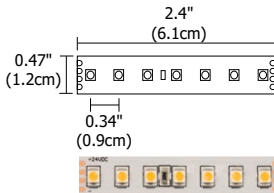

SS2C White LED Soft Strip: Commercial-grade LED Soft Strip with high CRI LEDs, offering superior color rendering and enhanced color. Flexible copper strip with optically clear protective coating, and industrial strength 3M™ tape backing. Dims with ELV or 0-10V dimmers (sold separately).

System	Voltage	Length in Feet	Color Temperature
SS2C	- 24V	- 40	- 27K
SS2C 2.5W LED Soft Strip	24V 24 Volt	1-40 1 foot increments up to 40 feet	22K 2200K Amber White 35K 3500K Neutral White 27K 2700K Very Warm White 40K 4000K Cool White 30K 3000K Warm White 57K 5700K Daylight White

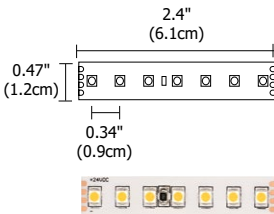

SS5C White LED Soft Strip: Commercial-grade LED Soft Strip with high CRI LEDs, offering superior color rendering and enhanced color. Flexible copper strip with optically clear protective coating, and industrial strength 3M™ tape backing. Dims with ELV or 0-10V dimmers (sold separately).

System	Voltage	Length in Feet	Color Temperature
SS5C	- 24V	- 20	- 27K
SS5C 4.4W LED Soft Strip	24V 24 Volt	1-20 1 foot increments up to 20 feet	22K 2200K Amber White 35K 3500K Neutral White 27K 2700K Very Warm White 40K 4000K Cool White 30K 3000K Warm White 57K 5700K Daylight White

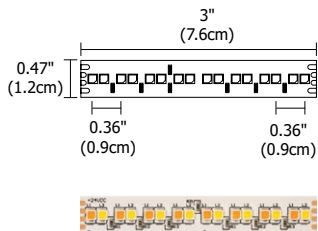

SS5C Warm Dim LED Soft Strip: Commercial-grade LED Soft Strip with high CRI LEDs, offering superior color rendering and enhanced color. Flexible copper strip with optically clear protective coating, and industrial strength 3M™ tape backing. Dims with ELV dimmers (sold separately) and dim to 2200K.

System	Voltage	Length in Feet	Color Temperature
SS5C	- 24V	- 20	- 27D
SS5C 5W LED Soft Strip	24V 24 Volt	1-20 1 foot increments up to 20 feet	27D 2700K Warm Dim 30D 3000K Warm Dim

A Division of PureEdge Lighting 1718 W. Fullerton Chicago, IL 60614 • Ph: 773.770.1196 • Fax: 773.883.6128 • www.purelighting.com

COMPANY		FIXTURE TYPE		DATE	
PROJECT		APPROVED BY			





LED SOFT STRIP

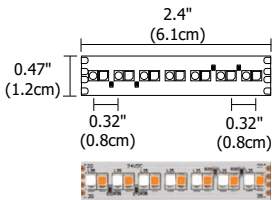

SS5C Tunable White LED Soft Strip: Provides variable color temperatures of commercial-grade high CRI LEDs. Flexible copper strip with optically clear protective coating, and industrial strength 3M™ tape backing. Compatible with DMX controls.

System	Voltage	Length in Feet	Color Temperature
SS5C	- 24V	- 20	- 2K4K
SS5C 5W LED Soft Strip	24V 24 Volt	1-20 1 foot increments up to 20 feet	2K4K Tunable White 2000K - 4000K

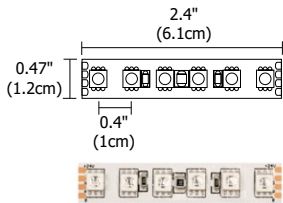
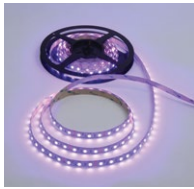

SS5 RGB LED Soft Strip: Provides dynamic color effects with red, green and blue LEDs. Flexible copper strip with optically clear protective coating, and industrial strength 3M™ tape backing. Compatible with DMX controls.

System	Voltage	Length in Feet	Color Temperature
SS5	- 24V	- 20	- RGB
SS5 5W LED Soft Strip	24V 24 Volt	1-20 1 foot increments up to 20 feet	RGB Red, Green, and Blue

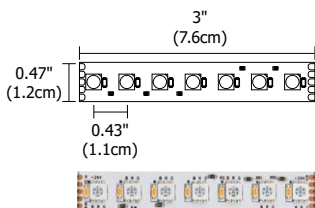
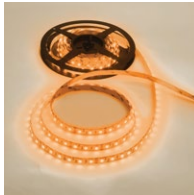

SS6 RGBW LED Soft Strip: Provides dynamic color effects with red, green, blue and White LEDs. Flexible copper strip with optically clear protective coating, and industrial strength 3M™ tape backing. Compatible with DMX controls.

System	Voltage	Length in Feet	Color Temperature
SS6	- 24V	- 16	- RGB+W
SS6 6.3W LED Soft Strip	24V 24 Volt	1-16 1 foot increments up to 16 feet	RGB+W Red, Green, Blue, and 2000K White

A Division of PureEdge Lighting 1718 W. Fullerton Chicago, IL 60614 • Ph: 773.770.1196 • Fax: 773.883.6128 • www.purelighting.com



COMPANY		FIXTURE TYPE		DATE	
PROJECT		APPROVED BY			



PICTURE FRAME INSTALLATION

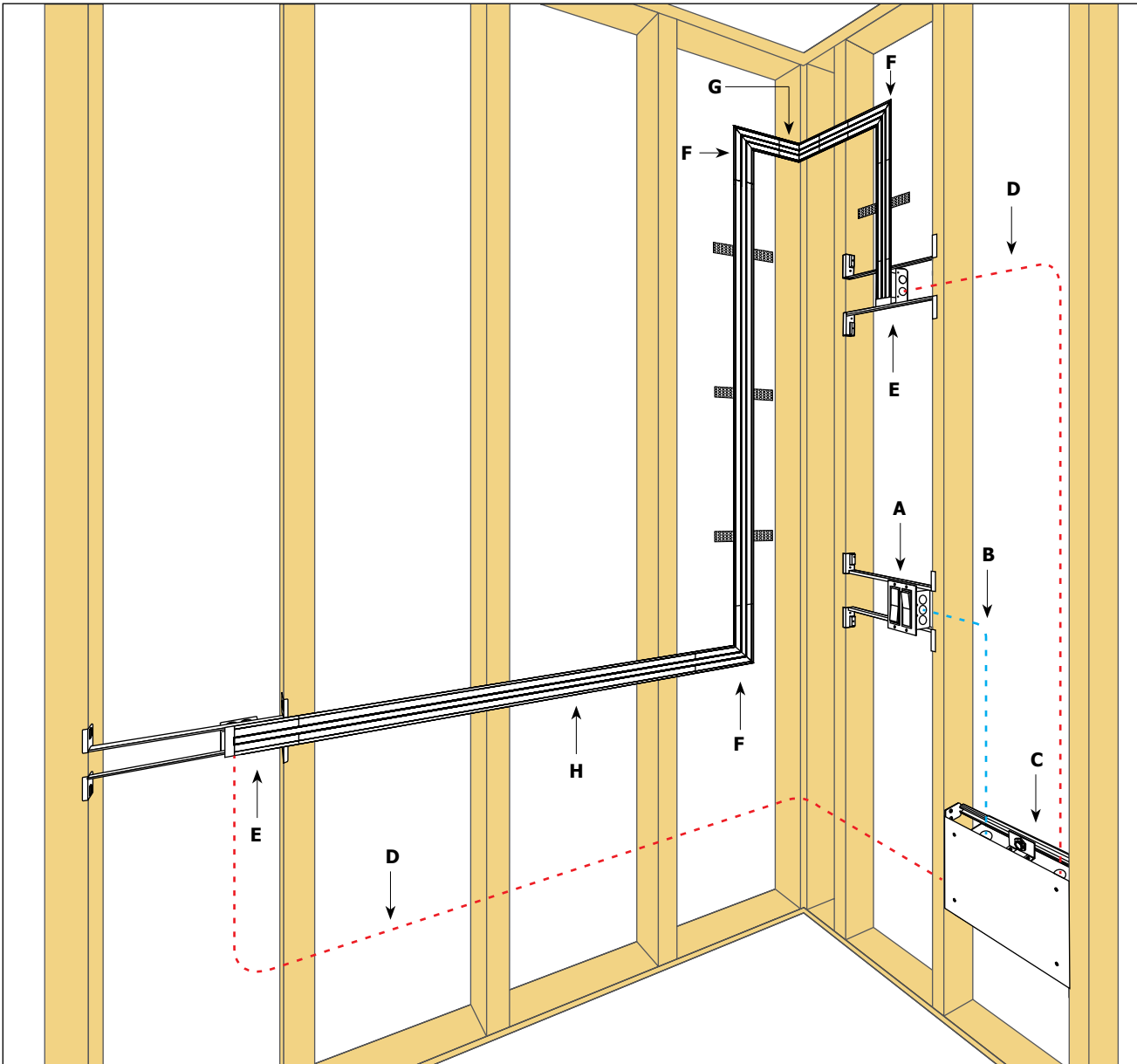

- A.** Dimmer or Switch
- B.** 120VAC wiring
- C.** 120V/24VDC remote power supply with In-Wall Mounting Kit, for more remote power supplies
- D.** 24VDC, Class 2 wiring
- E.** End Feed Power Channel Connector with Junction Box
- F.** L-Picture Frame Channel Connector
- G.** Inside Corner Channel Connector
- H.** TruLine Channel

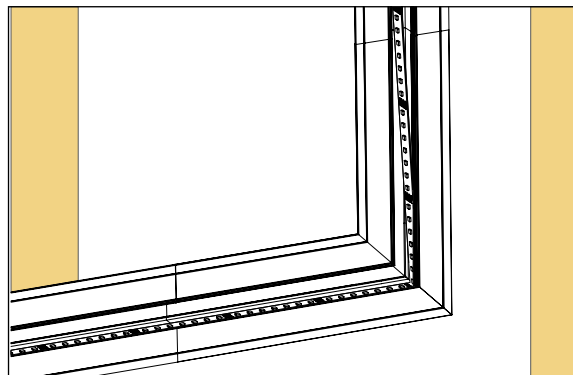

LEDs on Side of Channel

A Division of PureEdge Lighting 1718 W. Fullerton Chicago, IL 60614 • Ph: 773.770.1196 • Fax: 773.883.6128 • www.purelighting.com



COMPANY		FIXTURE TYPE		DATE	
PROJECT		APPROVED BY			



ROOM WRAPPING INSTALLATION

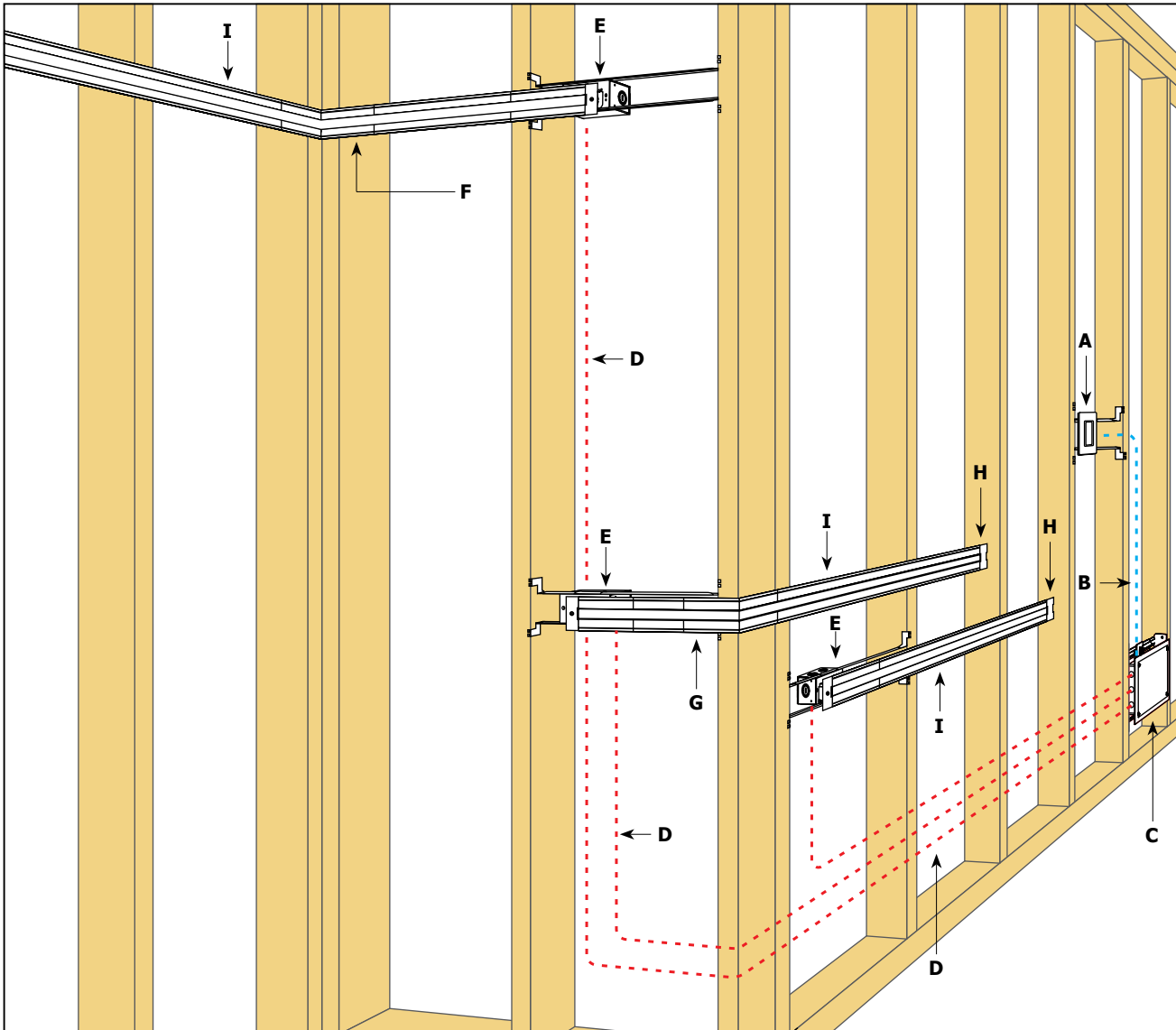

- A.** Dimmer or Switch
- B.** 120VAC wiring
- C.** 120V/24VDC remote power supply with In-Wall Mounting Kit, for more remote power supplies
- D.** 24VDC, Class 2 wiring
- E.** End Feed Power Channel Connector with Junction Box
- F.** Inside Corner Channel Connector
- G.** Outside Corner Channel Connector
- H.** Take-Up Box
- I.** TruLine Channel

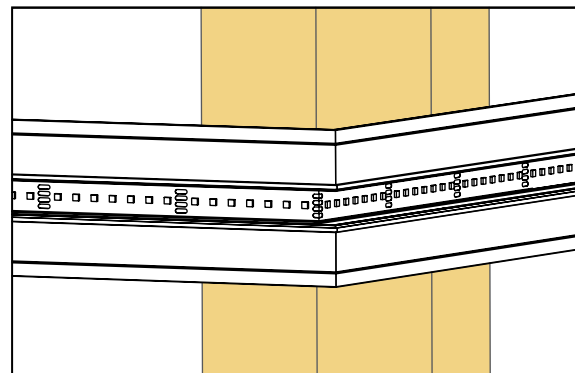

LEDs on Back of Channel

A Division of PureEdge Lighting 1718 W. Fullerton Chicago, IL 60614 • Ph: 773.770.1196 • Fax: 773.883.6128 • www.purelighting.com

COMPANY		FIXTURE TYPE		DATE	
PROJECT		APPROVED BY			

Product specification subject to change without notification. REV.06.02.17



TruLine .5A BIY, 24VDC BUILD-IT-YOURSELF

ASSEMBLED IN AMERICA



Application: 0-10V dimming for TruLine .5A
Power Supply: PSB-96W-010-24VDC (24VDC 96W output) | PSB-2X96W-010-24VDC (24VDC 2X96W output).
Dimming: Radio Ra2 (with GRX-TVI), Grafik Eye Qs (with GRX-TVI), Diva (with PP20); Nova T; Philips: Sunrise SR1200ZTUNV; Leviton: IP710-LF.

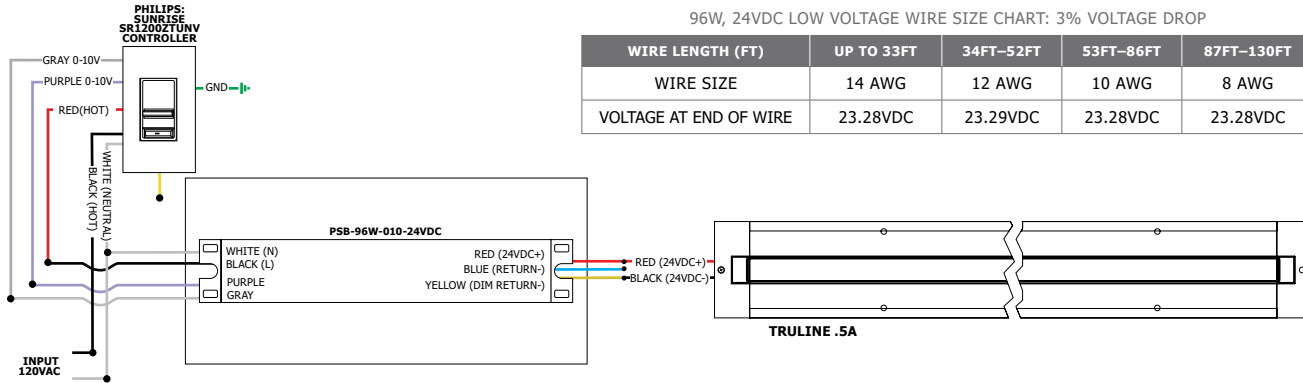

96W, 24VDC LOW VOLTAGE WIRE SIZE CHART: 3% VOLTAGE DROP

WIRE LENGTH (FT)	UP TO 33FT	34FT-52FT	53FT-86FT	87FT-130FT
WIRE SIZE	14 AWG	12 AWG	10 AWG	8 AWG
VOLTAGE AT END OF WIRE	23.28VDC	23.29VDC	23.28VDC	23.28VDC

2.5 WATTS PER FOOT - 22K, 27K, 30K, 35K, 40K AND 57K WHITE LEDS

LENGTH IN FEET	WATTS
1	3
2	5
3	8
4	10
5	13
6	15
7	17
8	20
9	22
10	24

LENGTH IN FEET	WATTS
11	27
12	29
13	32
14	34
15	37
16	39
17	41
18	44
19	46
20	48

LENGTH IN FEET	WATTS
21	51
22	54
23	56
24	58
25	61
26	63
27	66
28	68
29	70
30	72

LENGTH IN FEET	WATTS
31	75
32	78
33	80
34	82
35	85
36	87
37	90
38	92
39	94
40	96

5 WATTS PER FOOT - 22K, 27K, 27D, 30K, 30D, 35K, 40K, 57K, 2K4K AND RGB LEDS

LENGTH IN FEET	WATTS
1	5
2	10
3	16
4	20
5	24

LENGTH IN FEET	WATTS
6	30
7	34
8	40
9	44
10	48

LENGTH IN FEET	WATTS
11	54
12	58
13	64
14	68
15	72

LENGTH IN FEET	WATTS
16	78
17	82
18	88
19	92
20	96

6 WATTS PER FOOT - RGBW LEDS

LENGTH IN FEET	WATTS
1	6
2	12
3	18
4	24

LENGTH IN FEET	WATTS
5	30
6	36
7	42
8	48

LENGTH IN FEET	WATTS
9	54
10	60
11	66
12	72

LENGTH IN FEET	WATTS
13	78
14	84
15	90
16	96

COMPANY		FIXTURE TYPE		DATE	
PROJECT		APPROVED BY			

Product specification subject to change without notification. REV.06.02.17

A Division of PureEdge Lighting 1718 W. Fullerton Chicago, IL 60614 • Ph: 773.770.1196 • Fax: 773.883.6128 • www.purelighting.com



TruLine .5A BIY, 24VDC

ASSEMBLED IN AMERICA



TM-30-15 DATA: The data below is for SS2C and SS5C bare LED Soft Strips. Consistent color temperatures throughout a single strip and among multiple strips is possible through a 3 phase binning process in which each order is inspected with a color meter to ensure uniformity.

2200K | Rf: 83.9 | Rg: 94.9

COLOR VECTOR GRAPHIC

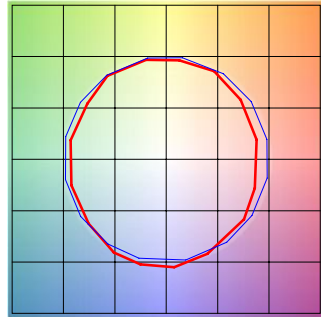

■ Test ■ Reference

HUE BIN	Rf	GRAPHIC SHIFTS %	
		CHROMA	HUE
1	77.6	-10.0%	1.8%
2	80.7	-7.5%	7.0%
3	79.5	-2.9%	8.9%
4	90.5	-3.1%	2.4%
5	93.9	-1.3%	1.9%
6	91.9	-0.9%	-0.2%
7	87.6	-6.3%	-2.7%
8	90.5	-5.4%	2.7%
9	83.8	-4.7%	6.5%
10	81.2	-2.5%	10.0%
11	83.3	3.9%	9.4%
12	86.4	5.6%	2.6%
13	86.2	4.5%	-12.4%
14	64.3	-1.0%	-21.9%
15	85.1	-4.4%	-7.5%
16	75.0	-9.9%	-12.0%

2700K | Rf: 87.7 | Rg: 96.1

COLOR VECTOR GRAPHIC

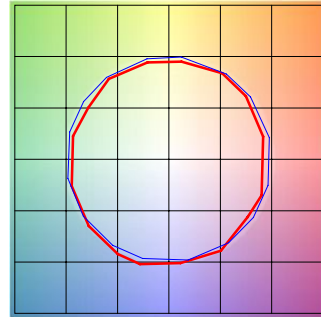

■ Test ■ Reference

HUE BIN	Rf	GRAPHIC SHIFTS %	
		CHROMA	HUE
1	86.4	-5.6%	2.3%
2	89.7	-3.3%	3.1%
3	90.5	-1.5%	3.8%
4	90.0	-4.3%	1.1%
5	92.9	-3.7%	0.2%
6	93.5	-2.5%	-0.8%
7	86.3	-7.2%	2.5%
8	90.7	-4.0%	3.2%
9	85.2	-2.4%	8.1%
10	81.7	0.9%	10.8%
11	85.4	4.5%	8.9%
12	88.7	5.7%	-1.4%
13	88.3	1.3%	-7.9%
14	85.1	2.4%	-10.4%
15	88.1	-4.8%	-2.7%
16	81.7	-4.3%	-10.9%

3000K | Rf: 88.1 | Rg: 99.7

COLOR VECTOR GRAPHIC

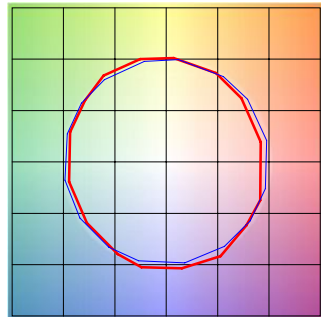

■ Test ■ Reference

HUE BIN	Rf	GRAPHIC SHIFTS %	
		CHROMA	HUE
1	87.7	-5.9%	-0.3%
2	87.9	-4.4%	4.3%
3	82.9	-1.2%	7.9%
4	89.9	0.6%	4.7%
5	92.7	3.0%	3.5%
6	92.7	3.6%	-1.7%
7	90.8	-1.3%	-4.4%
8	93.7	-2.5%	-2.2%
9	91.7	-3.7%	2.3%
10	85.5	-2.8%	7.8%
11	83.3	0.7%	11.0%
12	86.4	5.5%	3.8%
13	90.6	4.6%	-3.6%
14	85.6	5.9%	-8.4%
15	89.5	-0.6%	-5.7%
16	82.6	-2.7%	-12.0%

3500K | Rf: 86.1 | Rg: 95.5

COLOR VECTOR GRAPHIC

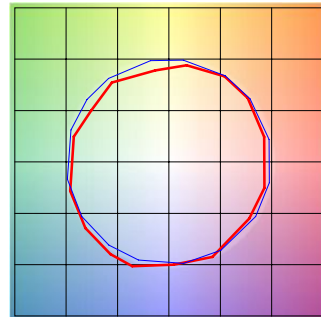

■ Test ■ Reference

HUE BIN	Rf	GRAPHIC SHIFTS %	
		CHROMA	HUE
1	86.6	-4.2%	3.4%
2	91.7	-1.4%	1.8%
3	94.9	-0.7%	0.4%
4	87.9	-4.5%	-4.1%
5	85.9	-10.3%	-2.7%
6	89.8	-5.2%	-0.4%
7	79.6	-9.5%	6.5%
8	87.6	-4.0%	5.7%
9	81.4	-0.5%	11.8%
10	78.3	3.3%	11.4%
11	85.7	6.3%	6.1%
12	86.3	7.1%	-4.6%
13	86.1	-0.7%	-9.6%
14	85.1	0.8%	-10.4%
15	83.4	-4.1%	-5.3%
16	82.5	-3.6%	-5.7%

4000K | Rf: 87.6 | Rg: 96.8

COLOR VECTOR GRAPHIC

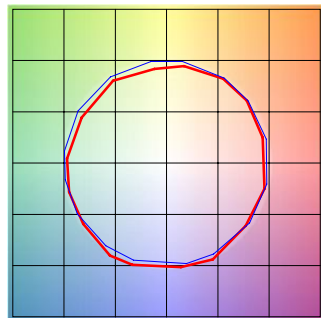

■ Test ■ Reference

HUE BIN	Rf	GRAPHIC SHIFTS %	
		CHROMA	HUE
1	89.0	-3.1%	2.1%
2	93.2	-0.9%	1.3%
3	94.3	-1.1%	0.7%
4	89.5	-4.0%	-2.3%
5	87.6	-7.8%	-1.8%
6	92.2	-4.6%	0.1%
7	87.4	-6.6%	3.6%
8	85.7	-3.8%	7.0%
9	81.5	-1.3%	12.4%
10	80.0	0.9%	11.4%
11	83.3	5.9%	8.7%
12	89.7	4.8%	-0.3%
13	88.5	2.4%	-6.3%
14	92.7	4.0%	-3.8%
15	86.1	-1.6%	-4.5%
16	85.0	-1.4%	-5.0%

5700K | Rf: 80.3 | Rg: 91.5

COLOR VECTOR GRAPHIC

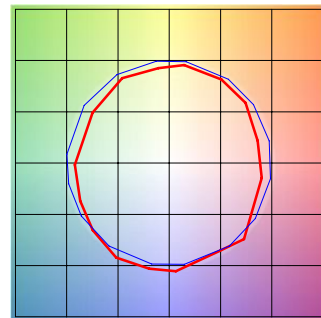

■ Test ■ Reference

HUE BIN	Rf	GRAPHIC SHIFTS %	
		CHROMA	HUE
1	73.8	-11.2%	2.6%
2	83.7	-5.5%	5.8%
3	84.2	-4.0%	5.5%
4	85.8	-3.5%	1.3%
5	85.3	-7.1%	0.6%
6	89.2	-5.8%	-2.2%
7	81.5	-10.7%	1.2%
8	75.7	-9.7%	8.5%
9	74.9	-7.8%	18.8%
10	67.8	-1.6%	18.0%
11	76.1	5.5%	12.0%
12	90.8	4.9%	-1.6%
13	83.6	5.0%	-9.5%
14	81.7	-1.2%	-10.0%
15	69.0	2.0%	-22.8%
16	83.2	-8.5%	-1.0%

A Division of PureEdge Lighting 1718 W. Fullerton Chicago, IL 60614 • Ph: 773.770.1196 • Fax: 773.883.6128 • www.purelighting.com



COMPANY		FIXTURE TYPE		DATE	
PROJECT		APPROVED BY			

Product specification subject to change without notification. REV.06.02.17

TruLine .5A BIY, 24VDC

ASSEMBLED IN AMERICA



TM-30-15 DATA: The data below is for SS2C and SS5C bare LED Soft Strips. Consistent color temperatures throughout a single strip and among multiple strips is possible through a 3 phase binning process in which each order is inspected with a color meter to ensure uniformity.

2700D | Rf: 89.5 | Rg: 100.8

COLOR VECTOR GRAPHIC

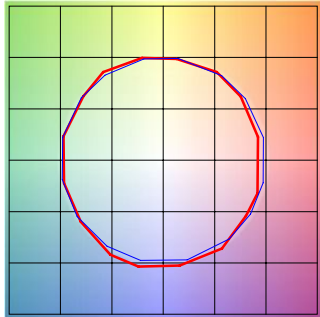

■ Test ■ Reference

HUE BIN	Rf	GRAPHIC SHIFTS %	
		CHROMA	HUE
1	88.8	-5.1%	1.4%
2	89.8	-2.7%	4.1%
3	87.2	0.3%	5.9%
4	92.3	-0.9%	1.0%
5	93.3	1.5%	1.7%
6	92.4	3.6%	-0.2%
7	92.2	-0.9%	-2.4%
8	96.7	-0.4%	-1.1%
9	92.3	-1.2%	3.7%
10	88.9	-0.0%	6.1%
11	86.4	5.1%	7.4%
12	88.2	6.3%	-0.9%
13	87.2	3.8%	-8.1%
14	84.2	3.8%	-11.0%
15	89.8	-2.6%	-4.3%
16	82.7	-3.4%	-11.1%

3000D | Rf: 89.8 | Rg: 101.4

COLOR VECTOR GRAPHIC

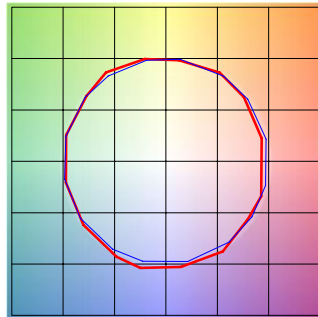

■ Test ■ Reference

HUE BIN	Rf	GRAPHIC SHIFTS %	
		CHROMA	HUE
1	90.2	-4.2%	1.5%
2	90.9	-2.0%	3.7%
3	87.9	0.8%	5.5%
4	92.1	-0.9%	0.6%
5	93.0	1.5%	1.6%
6	92.2	3.9%	-0.2%
7	92.1	-0.3%	-2.0%
8	96.7	0.0%	-1.2%
9	92.5	-0.6%	3.7%
10	88.3	1.1%	7.0%
11	87.2	4.1%	7.4%
12	87.2	6.7%	-1.0%
13	88.2	3.8%	-7.2%
14	85.3	4.3%	-9.9%
15	90.9	-2.2%	-3.6%
16	83.4	-2.2%	-11.2%

2000K only (2K4K) | Rf: 84.3 | Rg: 96.9

COLOR VECTOR GRAPHIC

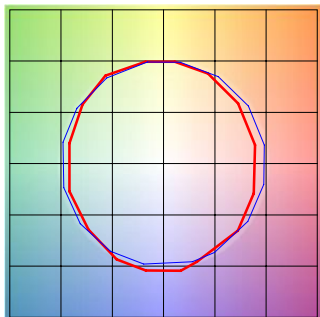

■ Test ■ Reference

HUE BIN	Rf	GRAPHIC SHIFTS %	
		CHROMA	HUE
1	80.3	-8.9%	1.7%
2	79.7	-7.0%	7.8%
3	78.9	-2.9%	10.0%
4	89.5	-0.5%	5.1%
5	94.4	0.7%	1.7%
6	92.1	2.4%	-0.3%
7	89.4	-2.4%	-5.9%
8	89.7	-6.4%	-0.2%
9	86.0	-4.9%	4.6%
10	81.8	-3.4%	9.3%
11	83.1	3.3%	9.7%
12	85.8	5.6%	3.3%
13	85.6	6.2%	-12.8%
14	61.7	-1.9%	-19.0%
15	79.7	-3.3%	-12.9%
16	78.1	-7.9%	-10.6%

4000K only (2K4K) | Rf: 89.6 | Rg: 99.1

COLOR VECTOR GRAPHIC

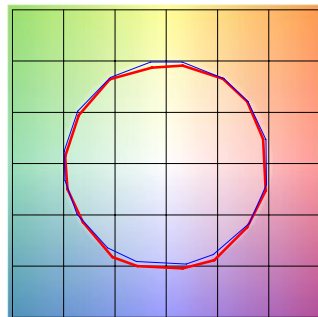

■ Test ■ Reference

HUE BIN	Rf	GRAPHIC SHIFTS %	
		CHROMA	HUE
1	91.3	-2.5%	1.0%
2	95.3	-0.5%	0.5%
3	94.3	-0.7%	1.1%
4	91.1	-3.4%	-1.1%
5	89.5	-5.6%	0.0%
6	94.6	-1.4%	1.3%
7	93.2	-3.0%	2.6%
8	91.3	-1.8%	4.6%
9	86.5	-0.9%	9.1%
10	83.3	-0.5%	9.5%
11	83.3	4.9%	9.0%
12	89.7	4.1%	1.7%
13	90.1	3.6%	-4.3%
14	93.4	5.2%	-2.1%
15	87.4	0.4%	-4.3%
16	86.6	0.4%	-6.1%

2K4K (3000K) | Rf: 90.2 | Rg: 101.4

COLOR VECTOR GRAPHIC

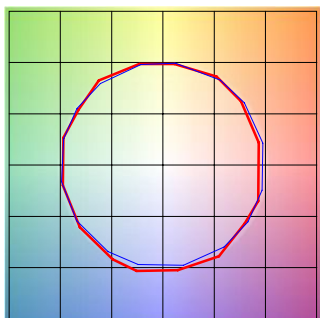

■ Test ■ Reference

HUE BIN	Rf	GRAPHIC SHIFTS %	
		CHROMA	HUE
1	90.9	-3.8%	1.3%
2	91.7	-1.9%	3.3%
3	88.7	0.7%	5.1%
4	92.4	-1.0%	0.7%
5	92.9	0.9%	1.7%
6	93.1	3.3%	-0.6%
7	91.0	-1.8%	-0.4%
8	97.0	0.2%	-1.1%
9	92.8	-0.5%	3.6%
10	88.3	1.0%	7.0%
11	87.1	3.8%	7.8%
12	87.6	6.5%	-0.3%
13	89.3	3.6%	-6.3%
14	86.1	4.5%	-9.1%
15	91.6	-1.9%	-3.1%
16	83.8	-1.5%	-11.2%

A Division of PureEdge Lighting 1718 W. Fullerton Chicago, IL 60614 • Ph: 773.770.1196 • Fax: 773.883.6128 • www.purelighting.com



COMPANY		FIXTURE TYPE		DATE	
PROJECT		APPROVED BY			

Product specification subject to change without notification. REV.06.02.17