

### DESCRIPTION

Twigg S1 Tunable White features a Square 1" milky White Diffuser Lens that provides uniform, Tunable White light. At 5 watts per foot, the 24VDC Vanity contains commercial-grade, 90+ CRI White LEDs. The Soft Strip can be controlled to operate at either 2000K-4000K, or any color temperature in between. Twigg is available in various 12" increments up to 120". May be ordered in 2 to 3 inch increments, see page 2 for exact lengths. Fixture may be ordered with a floating (may be located anywhere in the wall along the fixture length) 4 Inch Round Floating Canopy or Slim-Profile 1 inch rectangle Floating Junction Box. The system may be powered by a remote Uni Driver compatible with ELV or 0-10V dimmers, or Lutron Hi-Lume dimmable Remote 24VDC Power Supply or DMX. Fixture can be controlled with a variety of dimmers or controllers (sold separately). Fixture includes a Prorated 5 year warranty. [3D Assets available on 3D Warehouse.](#)

### FINISH



### APPLICATION (INDOOR ONLY)

Bathroom Vanity, Architectural Lighting, Task Lighting, General Lighting, Cove, Retail, and Closets

### LAMP

The average LED Life is 50,000 hours.

LED	CRI	POWER PER FOOT (WATTS)	TOTAL OUTPUT, LUMENS PER WATT	TOTAL OUTPUT, LUMENS PER FOOT
TUNABLE WHITE*	90+	5W	80	384
3000K	90+	2.5W	71	170
4000K	90+	2.5W	95	227

\*When both the 2000K & 4000K Soft Strips are on at full power, light output equals 3000K

### REMOTE POWER SUPPLIES\*, DIMMERS & CONTROLS (SOLD SEPARATELY)

- **TRIAC Dimming:** Single Pole Dual Dimming with dual remote universal power supplies with Lutron skylark controller (sold separately)
- **ELV Dimming:** Dual ELV dimming with dual ELV remote power supplies.  
Two ELV dimmers required (sold separately)
- **0-10V Dimming:** Dual 0-10v dimming with dual universal remote power supplies.  
Two 0-10v dimmers required (sold separately)
- **Dynamic Color Changing (DMX)**
- **Lutron Hi-lume**

Product Lens Canopy Length in Inches Color Temperature Finish

**TW2** - **S1** - **1RE** - **12IN** - **2K4K** - **SA**

TW2 Twigg Vanity 24VDC S1 Square 1" 1RE 1" Rectangle with Junction Box (with Remote Power Supply) 4SQ 4" Square Floating Canopy 12-120 Order in 12" increments up to 120". May be ordered in 3", 5", 8", or 10" increments.\* Chrome max 84". 2K4K 2000K-4000K Tunable White SA Satin Aluminum SN Satin Nickel CH Chrome (Max 84") BZ Antique Bronze BK Satin Black WH White

\*See p. 2 for actual lengths.

PROJECT	FIXTURE TYPE	DATE
---------	--------------	------



# TWIGGY S1 VANITY

## TUNABLE WHITE 2K4K, 24VDC SYSTEM



DESIGNED BY GREGORY KAY | ASSEMBLED IN AMERICA

REV.09.20.19

**LENGTH CHART** Please refer to chart below for overall length (with End Caps) for Twiggy S1 Vanity

Ordering Code	Overall Length (Inches)	Total Wattage (1 Fixture)	Minimum Power Supply (1 fixture)	Total Wattage (2 Fixtures)	Minimum Power Supply (2 fixtures)	Ordering Code	Overall Length (Inches)	Total Wattage (1 Fixture)	Minimum Power Supply (1 fixture)	Total Wattage (2 Fixtures)	Minimum Power Supply (2 fixtures)
12IN	13.1	5	PSB-2x40w-UNI-24VDC or PSB-100W-24VDC-2XK	10	PSB-2x40w-UNI-24VDC or PSB-100W-24VDC-2XK	68IN	68.3	28	PSB-2x40w-UNI-24VDC or PSB-100W-24VDC-2XK	56	PSB-2x40w-UNI-24VDC or PSB-100W-24VDC-2XK
15IN	15.5	6	PSB-2x40w-UNI-24VDC or PSB-100W-24VDC-2XK	12	PSB-2x40w-UNI-24VDC or PSB-100W-24VDC-2XK	70IN	70.7	29	PSB-2x40w-UNI-24VDC or PSB-100W-24VDC-2XK	58	PSB-2x40w-UNI-24VDC or PSB-100W-24VDC-2XK
17IN	17.9	7	PSB-2x40w-UNI-24VDC or PSB-100W-24VDC-2XK	14	PSB-2x40w-UNI-24VDC or PSB-100W-24VDC-2XK	72IN	73.1	30	PSB-2x40w-UNI-24VDC or PSB-100W-24VDC-2XK	60	PSB-2x40w-UNI-24VDC or PSB-100W-24VDC-2XK
20IN	20.3	8	PSB-2x40w-UNI-24VDC or PSB-100W-24VDC-2XK	16	PSB-2x40w-UNI-24VDC or PSB-100W-24VDC-2XK	75IN	75.5	31	PSB-2x40w-UNI-24VDC or PSB-100W-24VDC-2XK	62	PSB-2x40w-UNI-24VDC or PSB-100W-24VDC-2XK
22IN	22.7	9	PSB-2x40w-UNI-24VDC or PSB-100W-24VDC-2XK	18	PSB-2x40w-UNI-24VDC or PSB-100W-24VDC-2XK	77IN	77.9	32	PSB-2x40w-UNI-24VDC or PSB-100W-24VDC-2XK	64	PSB-2x40w-UNI-24VDC or PSB-100W-24VDC-2XK
24IN	25.1	10	PSB-2x40w-UNI-24VDC or PSB-100W-24VDC-2XK	20	PSB-2x40w-UNI-24VDC or PSB-100W-24VDC-2XK	80IN	80.3	33	PSB-2x40w-UNI-24VDC or PSB-100W-24VDC-2XK	66	PSB-2x40w-UNI-24VDC or PSB-100W-24VDC-2XK
27IN	27.5	11	PSB-2x40w-UNI-24VDC or PSB-100W-24VDC-2XK	22	PSB-2x40w-UNI-24VDC or PSB-100W-24VDC-2XK	82IN	82.7	34	PSB-2x40w-UNI-24VDC or PSB-100W-24VDC-2XK	68	PSB-2x40w-UNI-24VDC or PSB-100W-24VDC-2XK
29IN	29.9	12	PSB-2x40w-UNI-24VDC or PSB-100W-24VDC-2XK	24	PSB-2x40w-UNI-24VDC or PSB-100W-24VDC-2XK	84IN (Max shipping length for chrome)	85.1	35	PSB-2x40w-UNI-24VDC or PSB-100W-24VDC-2XK	70	PSB-2x40w-UNI-24VDC or PSB-100W-24VDC-2XK
32IN	32.3	13	PSB-2x40w-UNI-24VDC or PSB-100W-24VDC-2XK	26	PSB-2x40w-UNI-24VDC or PSB-100W-24VDC-2XK	87IN	87.5	36	PSB-2x40w-UNI-24VDC or PSB-100W-24VDC-2XK	72	PSB-2x40w-UNI-24VDC or PSB-100W-24VDC-2XK
34IN	34.7	14	PSB-2x40w-UNI-24VDC or PSB-100W-24VDC-2XK	28	PSB-2x40w-UNI-24VDC or PSB-100W-24VDC-2XK	89IN	89.9	37	PSB-2x40w-UNI-24VDC or PSB-100W-24VDC-2XK	74	PSB-2x40w-UNI-24VDC or PSB-100W-24VDC-2XK
36IN	37.1	15	PSB-2x40w-UNI-24VDC or PSB-100W-24VDC-2XK	30	PSB-2x40w-UNI-24VDC or PSB-100W-24VDC-2XK	92IN	92.3	38	PSB-2x40w-UNI-24VDC or PSB-100W-24VDC-2XK	76	PSB-2x60w-UNI-24VDC or PSB-100W-24VDC-2XK
39IN	39.5	16	PSB-2x40w-UNI-24VDC or PSB-100W-24VDC-2XK	32	PSB-2x40w-UNI-24VDC or PSB-100W-24VDC-2XK	94IN	94.7	39	PSB-2x40w-UNI-24VDC or PSB-100W-24VDC-2XK	78	PSB-2x60w-UNI-24VDC or PSB-100W-24VDC-2XK
41IN	41.9	17	PSB-2x40w-UNI-24VDC or PSB-100W-24VDC-2XK	34	PSB-2x40w-UNI-24VDC or PSB-100W-24VDC-2XK	96IN	97.1	40	PSB-2x40w-UNI-24VDC or PSB-100W-24VDC-2XK	80	PSB-2x60w-UNI-24VDC or PSB-100W-24VDC-2XK
44IN	44.3	18	PSB-2x40w-UNI-24VDC or PSB-100W-24VDC-2XK	36	PSB-2x40w-UNI-24VDC or PSB-100W-24VDC-2XK	99IN	99.5	41	PSB-2x40w-UNI-24VDC or PSB-100W-24VDC-2XK	82	PSB-2x60w-UNI-24VDC or PSB-100W-24VDC-2XK
46IN	46.7	19	PSB-2x40w-UNI-24VDC or PSB-100W-24VDC-2XK	38	PSB-2x40w-UNI-24VDC or PSB-100W-24VDC-2XK	101IN	101.9	42	PSB-2x40w-UNI-24VDC or PSB-100W-24VDC-2XK	84	PSB-2x60w-UNI-24VDC or PSB-100W-24VDC-2XK
48IN	49.1	20	PSB-2x40w-UNI-24VDC or PSB-100W-24VDC-2XK	40	PSB-2x40w-UNI-24VDC or PSB-100W-24VDC-2XK	104IN	104.3	43	PSB-2x40w-UNI-24VDC or PSB-100W-24VDC-2XK	86	PSB-2x60w-UNI-24VDC or PSB-100W-24VDC-2XK
51IN	51.5	21	PSB-2x40w-UNI-24VDC or PSB-100W-24VDC-2XK	42	PSB-2x60w-UNI-24VDC or PSB-100W-24VDC-2XK	106IN	106.7	44	PSB-2x40w-UNI-24VDC or PSB-100W-24VDC-2XK	88	PSB-2x60w-UNI-24VDC or PSB-100W-24VDC-2XK
53IN	53.9	22	PSB-2x40w-UNI-24VDC or PSB-100W-24VDC-2XK	44	PSB-2x40w-UNI-24VDC or PSB-100W-24VDC-2XK	108IN	109.1	45	PSB-2x40w-UNI-24VDC or PSB-100W-24VDC-2XK	90	PSB-2x60w-UNI-24VDC or PSB-100W-24VDC-2XK
56IN	56.3	23	PSB-2x40w-UNI-24VDC or PSB-100W-24VDC-2XK	46	PSB-2x40w-UNI-24VDC or PSB-100W-24VDC-2XK	111IN	111.5	46	PSB-2x40w-UNI-24VDC or PSB-100W-24VDC-2XK	92	PSB-2x60w-UNI-24VDC or PSB-100W-24VDC-2XK
58IN	58.7	24	PSB-2x40w-UNI-24VDC or PSB-100W-24VDC-2XK	48	PSB-2x40w-UNI-24VDC or PSB-100W-24VDC-2XK	113IN	113.9	47	PSB-2x40w-UNI-24VDC or PSB-100W-24VDC-2XK	94	PSB-2x60w-UNI-24VDC or PSB-100W-24VDC-2XK
60IN	61.1	25	PSB-2x40w-UNI-24VDC or PSB-100W-24VDC-2XK	50	PSB-2x40w-UNI-24VDC or PSB-100W-24VDC-2XK	116IN	116.3	48	PSB-2x40w-UNI-24VDC or PSB-100W-24VDC-2XK	96	PSB-2x60w-UNI-24VDC or PSB-100W-24VDC-2XK
63IN	63.5	26	PSB-2x40w-UNI-24VDC or PSB-100W-24VDC-2XK	52	PSB-2x40w-UNI-24VDC or PSB-100W-24VDC-2XK	118IN	118.7	49	PSB-2x40w-UNI-24VDC or PSB-100W-24VDC-2XK	98	PSB-2x60w-UNI-24VDC or PSB-100W-24VDC-2XK
65IN	65.9	27	PSB-2x40w-UNI-24VDC or PSB-100W-24VDC-2XK	54	PSB-2x40w-UNI-24VDC or PSB-100W-24VDC-2XK	120IN	121.1	50	PSB-2x40w-UNI-24VDC or PSB-100W-24VDC-2XK	100	PSB-2x60w-UNI-24VDC or PSB-2x100W-24VDC-2XK

PROJECT		FIXTURE TYPE		DATE	
---------	--	--------------	--	------	--

- TRIAC Dimming:** Single pole dimming with dual remote universal power supplies with Lutron skylark controller (sold separately)
- ELV Dimming:** Dual ELV dimming with dual ELV remote power supplies. Two ELV dimmers required (sold separately)
- 0-10V Dimming:** Dual 0-10v dimming with dual universal remote power supplies. Two 0-10v dimmers required (sold separately)
- Power Supply:** Remote, class 2, 24VDC output: 120vac input | Configuration 1: PSB-2x96W-UNI-24VDC with Remote Power Supply with Lutron Skylark Controller | Configuration 2: PSB-2x60w-ELV-24VDC Dual ELV Dimmers | Configuration 3: PSB-2x96w-UNI-24VDC with Dual 0-10V Dimming
- Dimming :** Dimmable with Dual ELV Dimmers, Dual 0-10V Dimmers, Single Pole DMX, Single Pole TRIAC.

### Configuration 1

S2-L-WH (TRIAC) Single Pole Dimming with Dual Universal Power Supplies

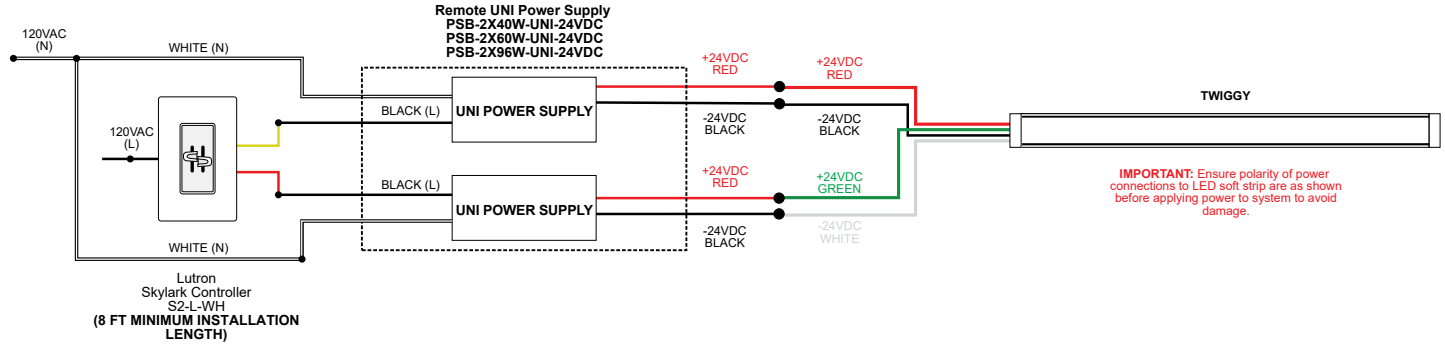

### Configuration 2

Dual ELV Dimmers controlled via individual Universal Power Supplies (Sold Separately)

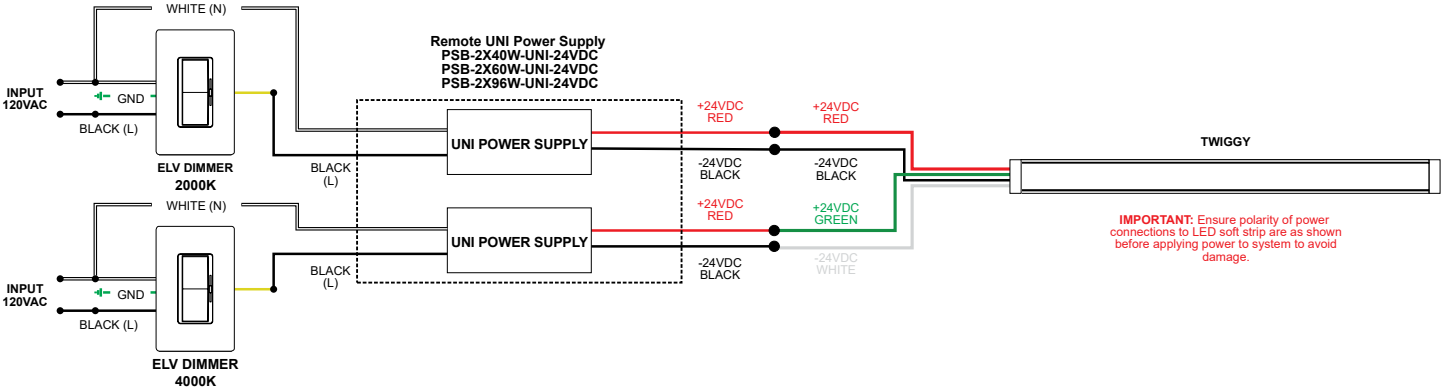

### Configuration 3

Dual Universal Power Supplies controlled via individual 0-10 Dimmers

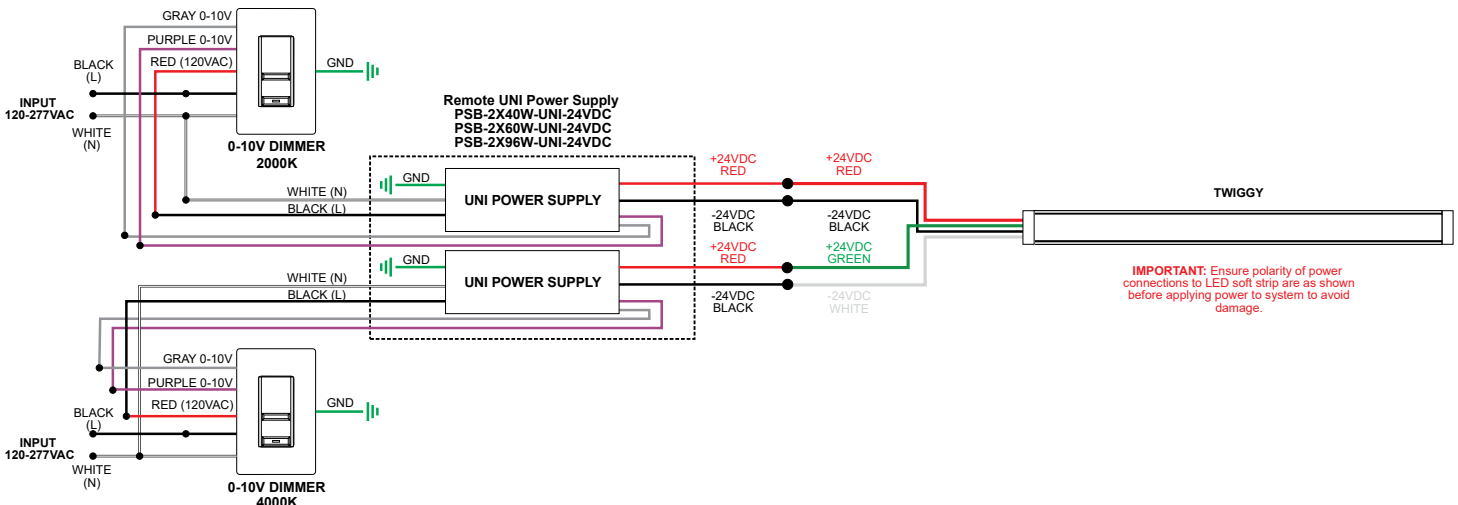

PROJECT	FIXTURE TYPE	DATE



### DESCRIPTION

The Tunable White Touch Controller is a full-touch controller that offers fast and accurate color temperature adjustment and independent brightness dimming of a single zone. Designed for Tunable White and Dual-Color LED installations, this controller adjusts color temperature and brightness for warm and cool white LEDs. It also saves three preset scenes. Independent smooth dimming with a 256 level brightness adjustment enables the DMX controller to achieve many colors within the full LED spectrum. Controller includes a Power Adapter that fits in Junction Box (not included) behind the controller. It contains an illuminated back light when powered off.

### APPLICATIONS

Indoor

### INSTALLATION

Fits in a single gang 2.5" deep Junction Box, not to be used with a Multi-Gang Box

### POWER INPUT

120/277VAC

### COMPATIBLE POWER SUPPLIES (SOLD SEPARATELY)

- PSB-100W-24VDC-2XK 100W output, 120/277V Input (12.2" wide x 6.5" high x 2.2" deep)
- PSB-2X100W-24VDC-2XK 2x100W output, 120/277V Input (14" wide x 10" high x 3" deep)
- PSB-3X100W-24VDC-2XK 3x100W output, 120/277V Input (17" wide x 13" high x 3" deep)
- PSB-4X100W-24VDC-2XK 4x100W output, 120/277V Input (17" wide x 13" high x 3" deep)

### OUTPUT SIGNAL

USITT DMX 512 (1990)

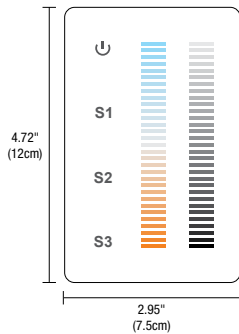

Product	Type	Finish
<b>CDMX1</b>	<b>2XK</b>	<b>WH</b>
CDMX1 DMX 1 Zone Touch Controller	2XK 2-Color	WH White

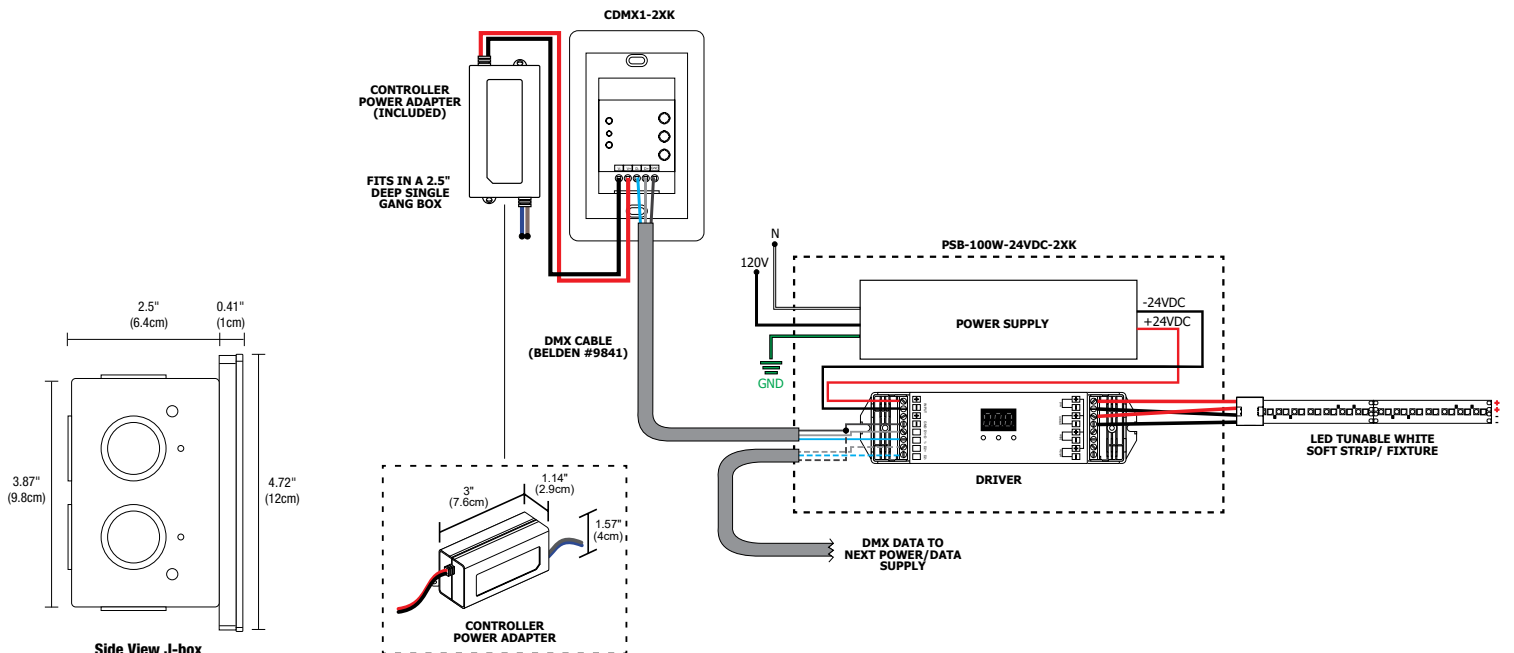

PROJECT	FIXTURE TYPE	DATE
---------	--------------	------



# TWIGGY S1 VANITY

TUNABLE WHITE 2K4K, 24VDC SYSTEM



DESIGNED BY GREGORY KAY | ASSEMBLED IN AMERICA

REV.09.20.19

## Compatible Indoor Solid State Constant Voltage Power Supplies

UNIVERSAL POWER SUPPLIES & RECOMMENDED DIMMERS				
ORDERING CODE	PSB-2X40W-UNI-24VDC	PSB-2X60W-UNI-24VDC	PSB-2X96W-UNI-24VDC	PSB-4X96W-UNI-24VDC
<b>SPECIFICATIONS</b>				
<b>MAXIMUM LOAD</b>	2X40W	2X60W	2X96W	4X96W
<b>INPUT VOLTAGE</b>	120-277VAC	120-277VAC	120-277VAC	120-277VAC
<b>OUTPUT VOLTAGE</b>	24VDC	24VDC	24VDC	24VDC
<b>DIMENSIONS</b>	12.15" X 6.48" X 2.18"	12.15" X 6.48" X 2.18"	12.15" X 6.48" X 2.18"	17" X 13" X 3"
<b>CLASSIFICATION</b>	CLASS 2	CLASS 2	CLASS 2	CLASS 2
<b>IN-WALL MOUNTING</b>	PSB-2X40W-UNI-24VDC-IW	PSB-2X60W-UNI-24VDC-IW	PSB-2X96W-UNI-24VDC-IW	PSB-4X96W-UNI-24VDC-IW
<b>ELV DIMMING &amp; CONTROLS</b>				
LUTRON DIVA: DVELV-300P	•	•	•	•
LUTRON SKYLARK: SELV-300P	•	•	•	•
LUTRON RADIO RA2: RRD-6NA	•	•	•	•
LUTRON MAESTRO: MAELV-600	•	•	•	•
LUTRON SKYLARK S2-L	•	•	•	•
LEGRAND ADORNE: ADTP-703TUM4	•	•	•	•
<b>0-10 DIMMING &amp; CONTROLS</b>				
PHILIPS SUNRISE: SR1200ZTUNV	•	•	•	•
LUTRON DIVA:: DVTV-WH	•	•	•	•
LUTRON NOVA T: NTSTV-DV-XX	•	•	•	•
LUTRON GRAFIX EYE QS: QSGRJ-XP	•	•	•	•
LUTRON RADIO RA2: RRD-10ND	•	•	•	•
LEVITON: LEV40050	•	•	•	•
LEVITON IP710-LFZ			•	•
LEGRAND: ADPD4FBL3P2W4			•	•

The Solid State Constant Voltage Uni-Power Supply is compatible with most commercially available Dimmers:

Triac Dimmer : (Forward Phase) Typically used for the dimming of Incandescent and Low Voltage Magnetic Transformers

ELV Dimmer : (Reverse Phase) Dimming of Electronic Low Voltage Transformers and Power Supply's used for LED lighting

0-10 Dimmer : Dims the Low Voltage side of a 0-10 volt power supply commonly used in large scale lighting or commercial applications.

The Uni-Power Supply is recommended with any Siemens/Murray brand of arc fault breaker to overcome the issues with tripping the breakers with an ELV LED Low Voltage Drivers.

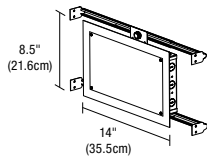

### 8.5" X 14" IN-WALL MOUNTING KIT<sup>†</sup>

Includes Power Supply, Box Cover, and Stud Hangers for installing Junction Box in wall. Select "IW" in the options section of compatible Power Supply ordering codes if an In-Wall Mounting Kit is needed.

**ORDERING CODES:** PSB-2X40W-UNI-24VDC-IW, PSB-2X160W-UNI-24VDC-IW

PROJECT	FIXTURE TYPE	DATE
---------	--------------	------



# TWIGGY S1 VANITY

TUNABLE WHITE 2K4K, 24VDC SYSTEM





DESIGNED BY GREGORY KAY | ASSEMBLED IN AMERICA

REV.09.20.19

## REQUIRED COMPONENTS 24VDC ELV Compatible Power Supplies

ELECTRONIC LOW-VOLTAGE (ELV) POWER SUPPLIES & RECOMMENDED DIMMERS <sup>†‡</sup>	
ORDERING CODE	PSB-2X60W-ELV-24VDC 
	<b>SPECIFICATIONS</b>
MAXIMUM LOAD	2X60W
INPUT VOLTAGE	120VAC
OUTPUT VOLTAGE	24VDC
DIMENSIONS	12.15" X 6.48" X 2.18"
CLASSIFICATION	CLASS 2
IN-WALL MOUNTING	PSB-2X60W-ELV-24VDC-IW
<b>DIMMING &amp; CONTROLS</b>	
LUTRON DIVA: DVELV-300P	•
LUTRON SKYLARK: SELV-300P	•
LUTRON RADIO RA2: RRD-6NA	•
LUTRON MAESTRO: MAELV-600	•
LEGRAND ADORNE: ADTP-703TUM4	•

ELECTRONIC LOW-VOLTAGE (ELV) POWER SUPPLIES & RECOMMENDED DIMMERS <sup>†‡</sup>		
ORDERING CODE	PSB-2X100W-ELV-24VDC 	PSB-4X100W-ELV-24VDC 
	<b>SPECIFICATIONS</b>	
MAXIMUM LOAD	2X96W	4X96W
INPUT VOLTAGE	120VAC	120VAC
OUTPUT VOLTAGE	24VDC	24VDC
DIMENSIONS	12.15" X 6.48" X 2.18"	17" X 13" X 3"
CLASSIFICATION	CLASS 2	CLASS 2
IN-WALL MOUNTING	PSB-2X100W-ELV-24VDC-IW	N/A
<b>DIMMING &amp; CONTROLS</b>		
LUTRON DIVA: DVELV-300P	•	•
LUTRON SKYLARK: SELV-300P	•	•
LUTRON RADIO RA2: RRD-6NA	•	•
LUTRON MAESTRO: MAELV-600	•	•
LEGRAND ADORNE: ADTP-703TUM4	•	•

<sup>†</sup>22K - 57K color temperatures are compatible with 0-10V, ELV, and Lutron Hi-lume® Power Supplies. Warm Dim (27D, 30D) color temperatures are only compatible with ELV power supplies. Tunable White (2K4K) color temperature is compatible with 0-10V, ELV, DMX, and Lutron Hi-lume® Power Supplies.

<sup>‡</sup>Electrical Panels using Seimens/Murray AFCI breakers are not compatible with this ELV transformer. Use 0-10 Volt power supply's with this breaker.

With N-Lite Dimming Do Not use ELV power supplies, use only 0-10 volt or Uni drivers power supplies

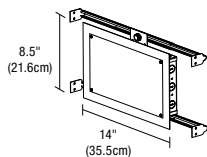

### 8.5" X 14" IN-WALL MOUNTING KIT<sup>‡</sup>

Includes Power Supply, Box Cover, and Stud Hangers for installing Junction Box in wall. Select "IW" in the options section of compatible Power Supply ordering codes if an In-Wall Mounting Kit is needed.

**ORDERING CODES:** PSB-2X60W-ELV-24VDC-IW, PSB-2X100W-ELV-24VDC-IW

PROJECT	FIXTURE TYPE	DATE
---------	--------------	------



# TWIGGY S1 VANITY



TUNABLE WHITE 2K4K, 24VDC SYSTEM



DESIGNED BY GREGORY KAY | ASSEMBLED IN AMERICA

REV.09.20.19

## REQUIRED COMPONENTS 24VDC 0-10V Compatible Power Supplies

0-10 VOLT (010) POWER SUPPLIES & RECOMMENDED DIMMERS†			
ORDERING CODE	PSB-2X96W-010-24VDC 	PSB-3X96W-010-24VDC 	PSB-4X96W-010-24VDC 
<b>SPECIFICATIONS</b>			
MAXIMUM LOAD	2X96W	3X96W	4X96W
INPUT VOLTAGE	120-277VAC	120-277VAC	120-277VAC
OUTPUT VOLTAGE	24VDC	24VDC	24VDC
DIMENSIONS	12.15" X 6.48" X 2.18"	14" X 10" X 3"	17" X 13" X 3"
CLASSIFICATION	CLASS 2	CLASS 2	CLASS 2
IN-WALL MOUNTING	PSB-2X96W-010-24VDC-IW	N/A	N/A
<b>DIMMING &amp; CONTROLS</b>			
PHILIPS SUNRISE: SR1200ZTUNV	•	•	•
LUTRON DIVA: DDTV-WH	•	•	•
LUTRON NOVA T: NTSTV-DV-XX	•	•	•
LUTRON GRAFIX EYE QS: QSGRJ-XP	•	•	•
LUTRON RADIO RA2: RRD-10ND	•	•	•
LEVITON: LEV40050	•	•	•
LEVITON IP710-LFZ	•	•	•
LEGRAND: ADPD4FBL3P2W4	•	•	•

Tunable White (2K4K) Color Temperature is compatible with 0-10V, ELV, DMX, and Lutron Hi-lume® Power Supplies.

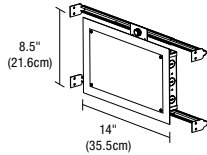

### 8.5" X 14" IN-WALL MOUNTING KIT

Includes Power Supply, Box Cover, and Stud Hangers for installing Junction Box in wall. Select "IW" in the options section of compatible Power Supply ordering codes if an In-Wall Mounting Kit is needed.

**ORDERING CODES:** PSB-2X96W-010-24VDC-IWW

PROJECT	FIXTURE TYPE	DATE
---------	--------------	------



# TWIGGY S1 VANITY





TUNABLE WHITE 2K4K, 24VDC SYSTEM



DESIGNED BY GREGORY KAY | ASSEMBLED IN AMERICA

REV.09.20.19

## REQUIRED COMPONENTS 24VDC DMX 2XK Tunable White Compatible Power Supplies

DYNAMIC COLOR CHANGING (DMX) POWER SUPPLIES & RECOMMENDED CONTROLLERS†				
ORDERING CODE	PSB-100W-24VDC-2XK 	PSB-2X100W-24VDC-2XK 	PSB-3X100W-24VDC-2XK 	PSB-4X100W-24VDC-2XK 
<b>SPECIFICATIONS</b>				
MAXIMUM LOAD	100W	2X100W	3X100W	4X100W
INPUT VOLTAGE	120-277VAC	120-277VAC	120-277VAC	120-277VAC
OUTPUT VOLTAGE	24VDC	24VDC	24VDC	24VDC
DIMENSIONS	12.14" X 6.48" X 2.18"	14" X 10" X 3"	17" X 13" X 3"	17" X 13" X 3"
CLASSIFICATION	CLASS 2	CLASS 2	CLASS 2	CLASS 2
IN-WALL MOUNTING	PSB-100W-24VDC-2XK-IW	N/A	N/A	N/A
<b>DIMMING &amp; CONTROLS</b>				
TUNABLE WHITE TOUCH CONTROLLER (CDMX1-2XK)	•	•	•	•

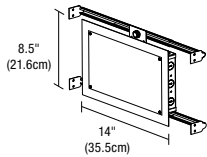

### 8.5" X 14" IN-WALL MOUNTING KIT

Includes Power Supply, Box Cover, and Stud Hangers for installing Junction Box in wall. Select "IW" in the options section of compatible Power Supply ordering codes if an In-Wall Mounting Kit is needed.

ORDERING CODES: PSB-100W-24VDC-2XK-IW

## REQUIRED COMPONENTS 24VDC Lutron Compatible Power Supply

LUTRON HI-LUME® PREMIER .1% ECOSYSTEM® 3-WIRE POWER SUPPLY & RECOMMENDED CONTROLLERS†	
ORDERING CODE	L3D0-96W24V-U 
<b>SPECIFICATIONS</b>	
MAXIMUM LOAD	96W
INPUT VOLTAGE	120-277VAC
OUTPUT VOLTAGE	24VDC
DIMENSIONS	10.5" X 5.5" X 2"
CLASSIFICATION	CLASS 2
<b>DIMMING &amp; CONTROLS</b>	
RADIO RA2	•
HOMEWORKS QS	•
PHPM-3F-120	•
PHPM-3F-DV	•
BCI-0-10	•

Tunable White (2K4K) Color Temperature is compatible with 0-10V, ELV, DMX, and Lutron Hi-lume® Power Supplies.

PROJECT	FIXTURE TYPE	DATE
---------	--------------	------



### TM-30-15 DATA

The data below is for SS5C bare LED Soft Strips. Consistent color temperatures throughout a single strip and among multiple strips is possible through a 3 phase binning process in which each order is inspected with a color meter to ensure uniformity.

#### 2000K ONLY (2K4K) | Rf: 84.3 | Rg: 96.9

Color Vector Graphic

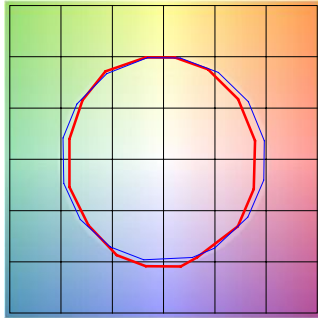

■ Test ■ Reference

HUE BIN	Rf	GRAPHIC SHIFTS %	
		CHROMA	HUE
1	80.3	-8.9%	1.7%
2	79.7	-7.0%	7.8%
3	78.9	-2.9%	10.0%
4	89.5	-0.5%	5.1%
5	94.4	0.7%	1.7%
6	92.1	2.4%	-0.3%
7	89.4	-2.4%	-5.9%
8	89.7	-6.4%	-0.2%
9	86.0	-4.9%	4.6%
10	81.8	-3.4%	9.3%
11	83.1	3.3%	9.7%
12	85.8	5.6%	3.3%
13	85.6	6.2%	-12.8%
14	61.7	-1.9%	-19.0%
15	79.7	-3.3%	-12.9%
16	78.1	-7.9%	-10.6%

#### 4000K ONLY (2K4K) | Rf: 89.6 | Rg: 99.1

Color Vector Graphic

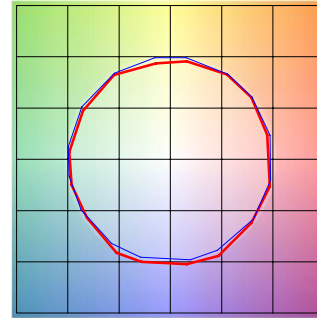

■ Test ■ Reference

HUE BIN	Rf	GRAPHIC SHIFTS %	
		CHROMA	HUE
1	91.3	-2.5%	1.0%
2	95.3	-0.5%	0.5%
3	94.3	-0.7%	1.1%
4	91.1	-3.4%	-1.1%
5	89.5	-5.6%	0.0%
6	94.6	-1.4%	1.3%
7	93.2	-3.0%	2.6%
8	91.3	-1.8%	4.6%
9	86.5	-0.9%	9.1%
10	83.3	-0.5%	9.5%
11	83.3	4.9%	9.0%
12	89.7	4.1%	1.7%
13	90.1	3.6%	-4.3%
14	93.4	5.2%	-2.1%
15	87.4	0.4%	-4.3%
16	86.6	0.4%	-6.1%

#### 2K4K (3000K) | Rf: 90.2 | Rg: 101.4

Color Vector Graphic

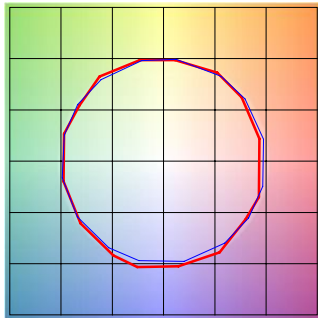

■ Test ■ Reference

HUE BIN	Rf	GRAPHIC SHIFTS %	
		CHROMA	HUE
1	90.9	-3.8%	1.3%
2	91.7	-1.9%	3.3%
3	88.7	0.7%	5.1%
4	92.4	-1.0%	0.7%
5	92.9	0.9%	1.7%
6	93.1	3.3%	-0.6%
7	91.0	-1.8%	-0.4%
8	97.0	0.2%	-1.1%
9	92.8	-0.5%	3.6%
10	88.3	1.0%	7.0%
11	87.1	3.8%	7.8%
12	87.6	6.5%	-0.3%
13	89.3	3.6%	-6.3%
14	86.1	4.5%	-9.1%
15	91.6	-1.9%	-3.1%
16	83.8	-1.5%	-11.2%

PROJECT	FIXTURE TYPE	DATE
---------	--------------	------