

TIE STIX LED SUSPENSION

DYNAMIC/TUNABLE WHITE CENTER FEED DIRECT DOWN LIGHT

DESIGNED BY GREGORY KAY | ASSEMBLED IN AMERICA

REV 06.24.20



DESCRIPTION

Tie Stix Center Feed Dynamic/Tunable White is a linear LED suspension that creates a clean, Direct beam of light through a Diffused White lens with a 100° beam spread. Using the latest in LED Technology Dynamic/Tunable White, you have full control over the color temperature from 2000K (Sunset) to 4000K (Cool White) independent from the level of brightness. Use with two dimmers (one for 2000K and one for 4000K) or, our proprietary Tunable White Controller for fast and accurate adjustment with three pre-set scenes. The Tie Stix Center Feed Dynamic/Tunable White suspension is available in 6 standard sizes 39", 48", 60", 72", 84" and 96". Choose from eleven versatile finishes, six Metal and five Genuine Hardwood options that pair perfectly with the metal hardware. Add the optional Fast Jack 12V Port Canopy (**C1**) for mounting Fast Jack fixtures to easily accommodate a variety of moods and tasks. The suspension includes 12' of adjustable aircraft cables. Order **TXSP** with power supplies included in the canopy or **TXSR** remote power supplies, sold separately. Includes a 5-year pro-rated warranty. For custom lengths and quotes, email our design team design@PureEdgeLighting.com.

LAMPING

Tunable White (2K4K):	5 Watts @ 30K	10 Watts @ 30K
Lumen Output:	209 Lm/Ft	483 Lm/Ft
CRI:	95+	95+
Lens:	Diffused White 100° beam spread	
Average LED life is 60,000 hours.		

ELECTRICAL

TXSP:	Power supplies in Canopy
Power:	120V/24V Dual Uni-Drivers. Optional Fast Jack Power Supply; optional 12VAC electronic low voltage LED power supply.
Dimming:	Dual ELV, Triac (Magnetic) or 0-10V dimming
TXSR:	Remote Power Supply Options:
Power:	24VDC Class 2 wiring, 2x UNIVERSAL Remote Power Supplies (dims Triac, ELV or 0-10V), Optional Fast Jack Power Supply; 12VAC electronic low voltage LED power supply
Dimming:	Universal Dimming (TRIAC, ELV, 0-10V), Lutron Hi-Lume®, DALI, or DMX pgs 4-6, sold separately
Power Consumed:	5 or 10 watts per foot

HARDWARE FINISHES:



CHANNEL FINISHES:



*Wood finishes are authentic natural products, exact color and grain may vary. If you are trying to match an existing material, please contact us for a finish sample. We are able to accommodate some requests to pair our wood finishes with COM.

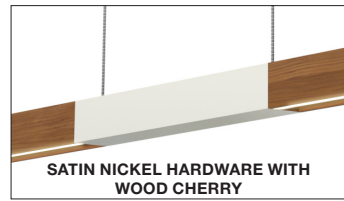
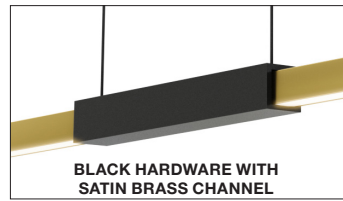

APPLICATIONS

Designed for indoor use only. Ideal applications in Residential, Commercial, Retail, and Hospitality environments.

APPROVALS

Damp Location, ETL Listed, Class 2 wiring, Title 24 , Made in America

System	Wattage Per Foot	Power Feed	Nominal Size (L)	Color Temperature	Canopy & Hardware Finish	Channel Finish
TXSP	5W	C	96	2K4K	B	BK
TXSP Tie Stix Suspension Power Supply In Canopy	5W 5 Watts 10W 10 Watts	C Center Feed C1 Center Feed with Fast Jack Port Remote Power Supply Only	40 39" 72 73" 48 49" 84* 85" 60 61" 96 97"	2K4K 2000K-4000K Dynamic / Tunable White	B Satin Black C Chrome S Satin Nickel W White Z Antique Bronze	BK Satin Black BZ Antique Bronze CH Chrome SB Satin Brass SN Satin Nickel WH White WC Wood Cherry WE Wood Espresso WM Wood Maple WN Wood Walnut WO Wood White Oak

PROJECT	FIXTURE TYPE	DATE
---------	--------------	------

TIE STIX LED SUSPENSION

DYNAMIC/TUNABLE WHITE CENTER FEED DIRECT DOWN LIGHT

REV 06.24.20

Nominal Lamp Data: Lamp data for the Tie Stix Suspension

WATTS PER FOOT	TXSR											
	5w (5 watts)						10w (10 watts)					
COLOR TEMPERATURE	20K	24K	27K	30K	35K	40K	20K	24K	27K	30K	35K	40K
LUMENS PER FOOT (lm/ft)	154	188	236	209	178	145	362	402	442	483	553	602
LUMENS PER WATT (lm/w)	48	50	51.3	52.4	54.4	56.4	36.2	40	44	48	55	60
CRI	85+	90+	95+	95+	84	84	85+	91.2	95+	95+	85+	85+

LENGTH CHART Actual Lengths for Wood & Metal Finishes

ACTUAL SIZE				
ORDERING CODE (Nominal Size)	WATTAGE (5 Watts per Foot)	WATTAGE (10 Watts per Foot)	WOOD CHANNEL OVERALL LENGTH (Inches)	METAL CHANNEL OVERALL LENGTH (Inches)
40	15	30	39.9"	39.5"
48	20	40	49.5"	49.1"
60	25	50	61.5"	61.1"
72	30	60	73.5"	73.1"
84*	35	70	85.5"	85.1"
96	40	80	97.5"	97.1"

*Maximum length for Chrome finish

C1 12RE CANOPY Remote Power Supply Only



FINISHING OPTION EXAMPLES



SATIN BLACK WITH WHITE FINISH

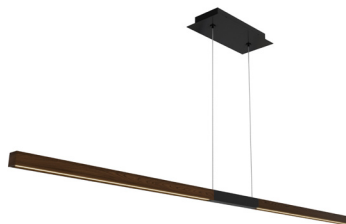

SATIN BLACK WITH WALNUT WOOD



CHROME WITH WHITE OAK



WHITE CANOPY WITH WHITE FINISH



SATIN NICKEL WITH CHERRY



SATIN BLACK WITH MAPLE



CHROME CANOPY WITH ANTIQUE BRONZE



WHITE CANOPY WITH BLACK FINISH



ANTIQUE BRONZE WITH SATIN BLACK

PROJECT		FIXTURE TYPE		DATE	
---------	--	--------------	--	------	--

TIE STIX LED SUSPENSION
 DYNAMIC/TUNABLE WHITE CENTER FEED DIRECT DOWN LIGHT

REV 06.24.20

Drawings: Dimension drawings for the Tie Stix LED Suspension, Center Feed

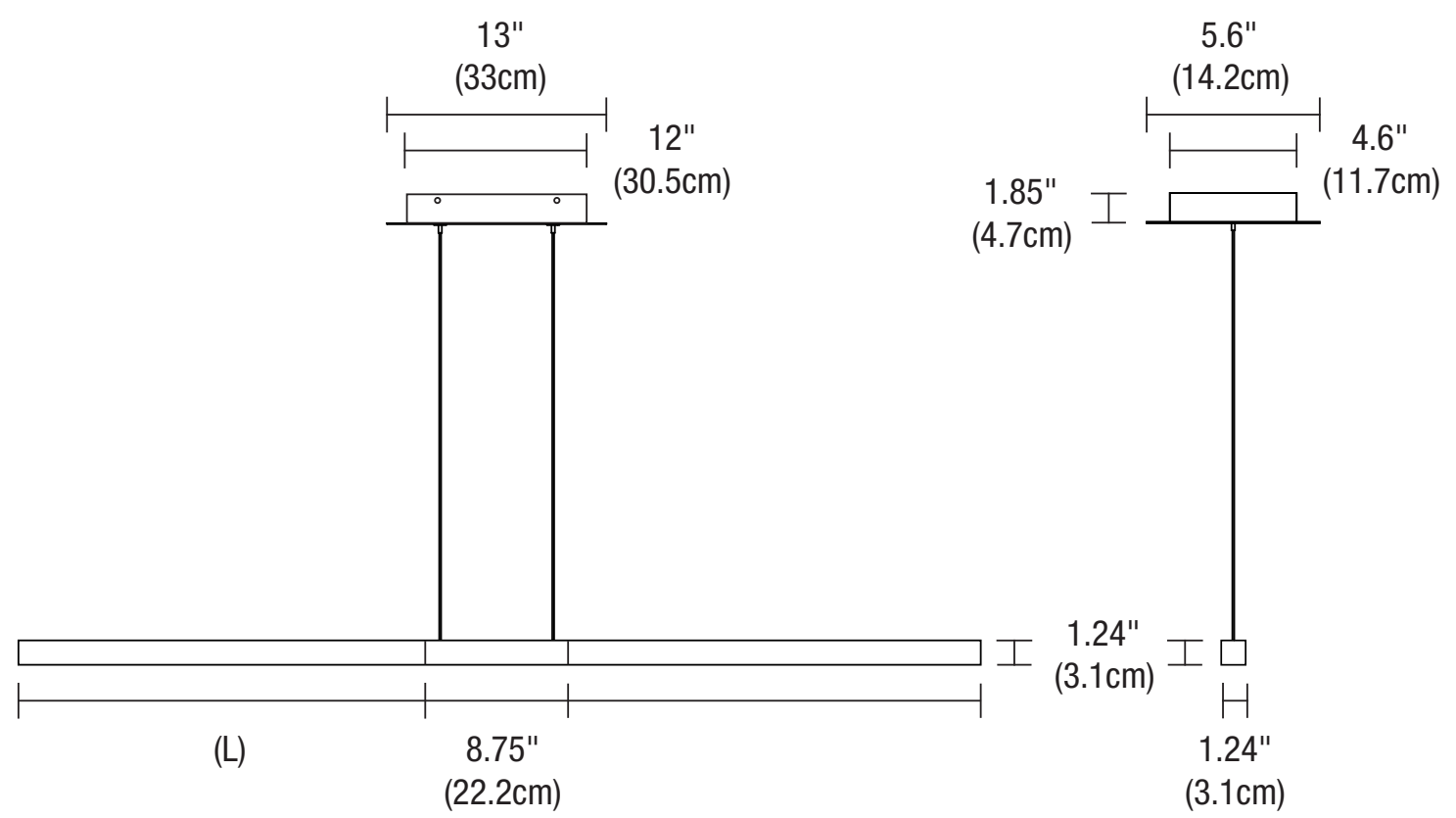
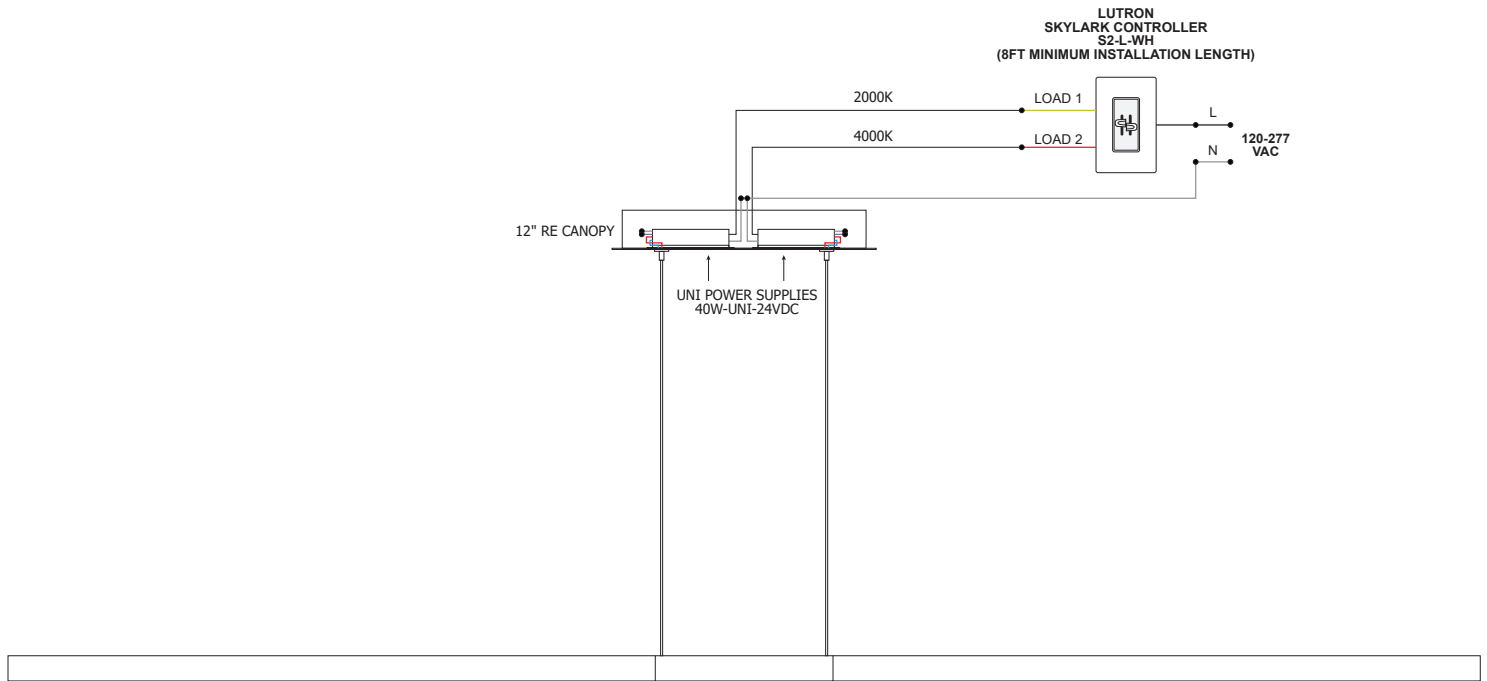

PROJECT	FIXTURE TYPE	DATE

UNIVERSAL POWER SUPPLIES & RECOMMENDED DIMMERS†				
ORDERING CODE	PSB-2X40W-UNI-24VDC	PSB-2X60W-UNI-24VDC	PSB-2X96W-UNI-24VDC	PSB-4X96W-UNI-24VDC
SPECIFICATIONS				
MAXIMUM LOAD	2X40W	2X60W	2X96W	4X96W
INPUT VOLTAGE	120-277VAC	120-277VAC	120-277VAC	120-277VAC
OUTPUT VOLTAGE	24VDC	24VDC	24VDC	24VDC
DIMENSIONS	12.15" X 6.48" X 2.18"	12.15" X 6.48" X 2.18"	12.15" X 6.48" X 2.18"	17" X 13" X 3"
CLASSIFICATION	CLASS 2	CLASS 2	CLASS 2	CLASS 2
IN-WALL MOUNTING	PSB-2X40W-UNI-24VDC-IW	PSB-2X60W-UNI-24VDC-IW	PSB-2X96W-UNI-24VDC-IW	NA
ELV DIMMING & CONTROLS				
LUTRON DIVA: DVELV-300P	•	•	•	•
LUTRON SKYLARK: SELV-300P	•	•	•	•
LUTRON RADIO RA2: RRD-6NA	•	•	•	•
LUTRON MAESTRO: MAELV-600	•	•	•	•
LEGRAND ADORNE: ADTP-703TUM4	•	•	•	•
0-10 DIMMING & CONTROLS				
PHILIPS SUNRISE: SR1200ZTUNV	•	•	•	•
LUTRON DIVA: DVTW-WH, DVSTV-WH	•	•	•	•
LUTRON NOVA T: NTSTV-DV-XX	•	•	•	•
LUTRON GRAFIK EYE QS: QSGRJ-XP	•	•	•	•
LUTRON RADIO RA2: RRD-10ND	•	•	•	•
LEVITON: LEV40050	•	•	•	•
LEVITON IP710-LFZ	•	•	•	•
LEGRAND: ADPD4FBL3P2W4	•	•	•	•
TRIAC DIMMING & CONTROLS				
LUTRON SKYLARK: S2-L-WH	•	•	•	•
LUTRON DVLV-600P-WH	•	•	•	•
LUTRON DVLV-603P-WH	•	•	•	•
LUTRON MALV-600-WH	•	•	•	•
LUTRON MALV-1000-WH	•	•	•	•
LUTRON MA-R-XX	•	•	•	•

- Flicker free dimming
- Aluminum casing for optimal heat dissipation
- Isolated output power per NEC and UL safety requirements
- UL & ETL recognized/ listed, meets UL 8750, 1310 requirements
- Auto-reset; short circuit, overload and thermal protection
- Class 2 power supply
- Efficient, High power factor > 0.90

- The Solid State Constant Voltage Uni-Power Supply is compatible with most commercially available Dimmers:
 - Triac Dimmer: (Forward Phase) Typically used for the dimming of Incandescent and Low Voltage Magnetic Transformers
 - ELV Dimmer: (Reverse Phase) Dimming of Electronic Low Voltage Transformers and Power Supply's used for LED lighting
 - 0-10 Dimmer: Dims the Low Voltage side of a 0-10 volt power supply commonly used in large scale lighting or commercial applications.
- The Uni-Power Supply is recommended with any Siemens/Murray brand of arc fault breaker to overcome the issues with tripping the breakers with an ELV LED Low Voltage Drivers.

MAXIMUM LENGTH

POWER SUPPLY	5 WATTS	10 WATTS
PSB-2X40W-UNI-24VDC	8 FEET	4 FEET
PSB-2X60W-UNI-24VDC	12 FEET	6 FEET
PSB-2X96W-UNI-24VDC	20 FEET	10 FEET

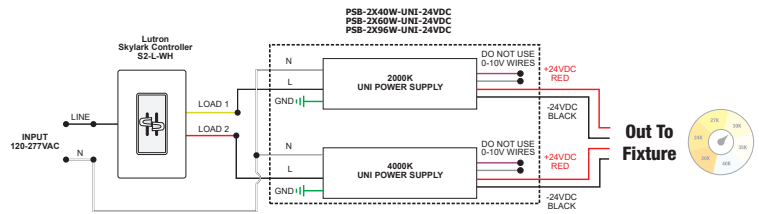

Configuration 1
S2-L-WH (TRIAC) Single Pole Dimming with Dual Universal Power Supplies

IN WALL MOUNTING OPTIONS

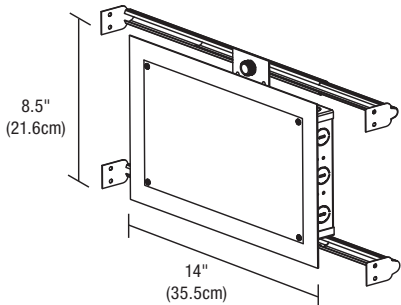

In-Wall Mounting Kit: Includes power supply, box cover and stud hangers for installing Junction Box in wall. Select "IW" in the options section of compatible power supply ordering codes if an In-Wall Mounting Kit is needed.

Ordering Codes 8.5 x 14.25 inch: PSB-2X40W-UNI-24VDC-IW, PSB-2X60W-UNI-24VDC-IW, PSB-2X96W-UNI-24VDC-IW

PROJECT		FIXTURE TYPE		DATE	
---------	--	--------------	--	------	--

DYNAMIC/TUNABLE WHITE CONTROLLER AND POWER SUPPLIES

24VDC INDOOR CONSTANT VOLTAGE POWER SUPPLIES WITH DMX DRIVERS

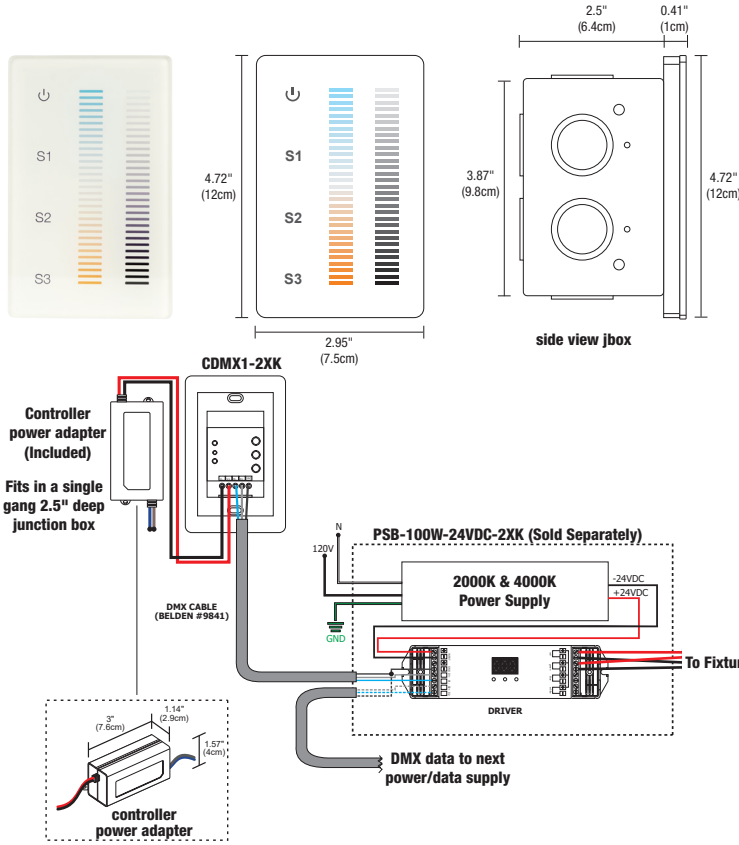

DESCRIPTION:

The Dynamic/Tunable White (**2K4K**) Touch Controller offers fast and accurate Color Temperature adjustment and the ability to regulate the Brightness Independently. The modern Glass faceplate features illuminated indicators, and a back-lit night light that softly illuminates the controller when powered off. Designed for Dynamic/Tunable White, and dual-color LED installations within a single zone. The two Vertical Touch sliders are precise and sensitive, allowing you to fine-tune your perfect Color Temperature at any point between **2000K (Sunset) to 4000K (Cool White)** while selecting over **250 levels** of Brightness in a smooth, uninterrupted transition. Create Thousands of Dynamic White Color Combinations while maintaining even Brightness and overall saturation. Easily save three pre-set scenes for different times of the day. Support health, performance, and general well-being using Human-Centric lighting by fine-tuning the biological effects that light has on the circadian cycle using the latest in LED technology. Includes a power adapter that fits behind the controller within a standard junction box and fits inside a standard single-gang receptacle (not for use in a multi-gang box). Use with an insulated, 24 AWG stranded, tinned copper wire (Belden #9841). Power Supplies are Sold Separately. Includes a 5 year pro-rated warranty.

APPLICATIONS:

Indoor

OUTPUT SIGNAL:

USITT DMX 512 (1990)

INSTALLATION:

Fits in a single gang 2.5 inch deep junction box. Not compatible with multi-gang boxes.

LABELS:

ROHS, FCC, Damp Location, ETL/UL

POWER INPUT:

120-240VAC

Product	Type	Finish
CDMX1	2XK	WH
CDMX1 DMX Single Zone Touch Controller	2XK 2 X Kelvin	WH White

DYNAMIC COLOR CHANGING (DMX) POWER SUPPLIES & RECOMMENDED CONTROLLERS*				
ORDERING CODE	PSB-100W-24VDC-2XK	PSB-2X100W-24VDC-2XK	PSB-3X100W-24VDC-2XK	PSB-4X100W-24VDC-2XK
MAXIMUM LOAD OF LED STRIP LENGTH	100W 5 WATTS - 20FT MAX. 10 WATTS - 10FT MAX.	2X100W 5 WATTS 2 X 20FT MAX. 10 WATTS - 2 X 10FT MAX.	3X100W 5 WATTS 3 X 20FT MAX. 10 WATTS - 3 X 10FT MAX.	4X100W 5 WATTS 4 X 20FT MAX. 10 WATTS - 4 X 10FT MAX.
INPUT VOLTAGE	120-277VAC	120-277VAC	120-277VAC	120-277VAC
OUTPUT VOLTAGE	24VDC	24VDC	24VDC	24VDC
DIMENSIONS	12.4" X 6.48" X 2.18"	14" X 10" X 3"	17" X 10" X 3"	17" X 10" X 3"
CLASSIFICATION	CLASS 2	CLASS 2	CLASS 2	CLASS 2
IN-WALL MOUNTING	PSB-100W-24VDC-2XK-IW	NA	NA	NA
DMX DYNAMIC/TUNABLE WHITE DIMMING & CONTROLS				
TUNABLE WHITE TOUCH CONTROLLER (CDMX1-2XK)	•	•	•	•

- Flicker free dimming
- Aluminum casing for optimal heat dissipation
- Isolated output power per NEC and UL safety requirements
- UL & ETL recognized/ listed, meets UL 8750, 1310 requirements

- Auto-reset; short circuit, overload and thermal protection
- Class 2 power supply
- Efficient, High power factor > 0.90

IN WALL MOUNTING OPTIONS

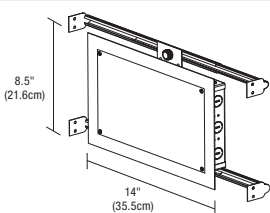

8.5 x 14 inch In-Wall Mounting Kit: Includes power supply, box cover and stud hangers for installing Junction Box in wall. Select "IW" in the options section of compatible power supply ordering codes if an In-Wall Mounting Kit is needed.

Ordering Codes: PSB-100W-24VDC-2XK-IW

PROJECT	FIXTURE TYPE	DATE
---------	--------------	------

LUTRON HI-LUME® PREMIER .1% ECOSYSTEM®†			
ORDERING CODES	L3D0-96W24V-U	2-WIRE ECOSYSTEM LTEA4U1UKL-CV240	3-WIRE ECOSYSTEM L3DA4U1UKL-CV240
SPECIFICATIONS			
MAXIMUM LOAD	96W	5W-40W	5W-40W
INPUT VOLTAGE	120-277VAC	120-277VAC	120-277VAC
OUTPUT VOLTAGE	24VDC	24VDC	24VDC
DIMENSIONS	10.5" X 5.5" X 2"	4" X 4.89" X 2.62"	4" X 4.89" X 2.62"
CLASSIFICATION	CLASS 2	CLASS 2	CLASS 2
DIMMING AND CONTROLS			
RADIO RA2	•	•	•
HOMEWORKS QS	•	•	•
PHPM-3F-120	•	•	•
PHPM-3F-DV	•	•	•
BCI-0-10	•	•	•

†24K - 57K color temperatures are compatible with 0-10V, ELV, and Lutron Hi-Lume® Power Supplies. Warm Dim (27D, 30D) color temperatures are only compatible with ELV power supplies.

*Tunable White (2K4K) Color Temperature is compatible with 0-10V, ELV, DMX, and Lutron Hi-Lume® Power Supplies. Dynamic Color (RGB, RGB+W) and Static Color (Amber, Blue, Green, or Red) are compatible with DMX Power Supplies.

**Tunable White (2K4K) uses one or two power supplies, dependent on the controller or dimmer(s) used.

Lutron Hi-Lume® can be used in both single or dual power formats, dependent on the controller or dimmer(s). Specify amount of Power Supplies based on this.

WIRING DIAGRAM: DMX Control with Lutron Grafik Eye Control Unit

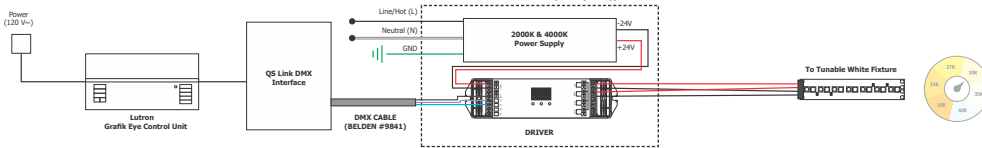

WIRING DIAGRAM: Line Voltage Dimming with Lutron Grafik Eye Control Unit

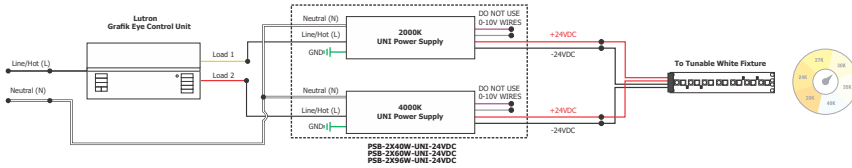

WIRING DIAGRAM: 0-10V Dimming with Lutron Grafik Eye Control Unit or Wall box controller

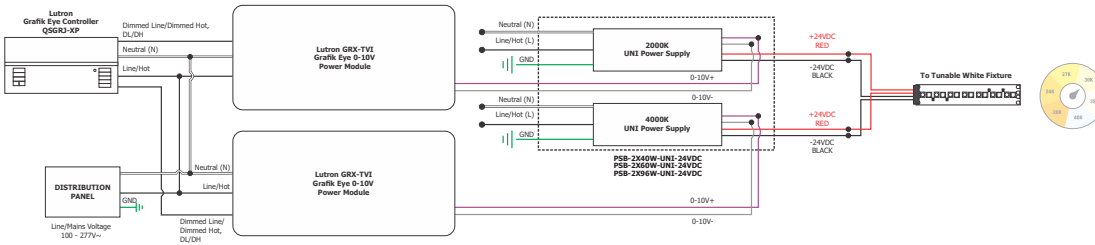

WIRING DIAGRAM: 2-Wire EcoSystem Panel

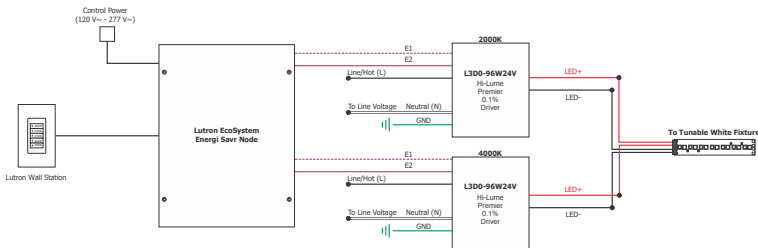

WIRING DIAGRAM: 3-Wire EcoSystem Wall Box

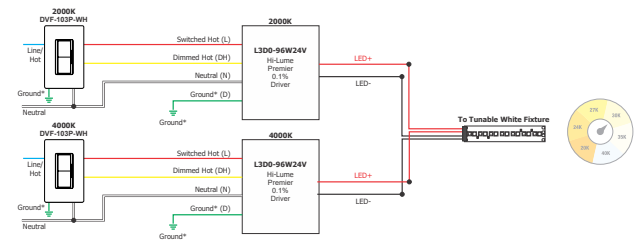

PROJECT	FIXTURE TYPE	DATE
---------	--------------	------

VANITY TM30 DATA

DYNAMIC/TUNABLE WHITE CENTER FEED DIRECT DOWN LIGHT

TM-30-15 DATA: The data below is for SS5C bare LED Soft Strips. Consistent color temperatures throughout a single strip and among multiple strips is possible through a 3 phase binning process in which each order is inspected with a color meter to ensure uniformity.

2000K ONLY (2K4K) | Rf: 84.3 | Rg: 96.9

Color Vector Graphic

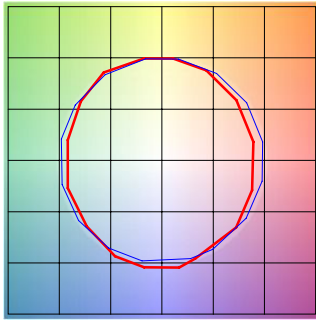

■ Test ■ Reference

HUE BIN	Rf	GRAPHIC SHIFTS %	
		CHROMA	HUE
1	80.3	-8.9%	1.7%
2	79.7	-7.0%	7.8%
3	78.9	-2.9%	10.0%
4	89.5	-0.5%	5.1%
5	94.4	0.7%	1.7%
6	92.1	2.4%	-0.3%
7	89.4	-2.4%	-5.9%
8	89.7	-6.4%	-0.2%
9	86.0	-4.9%	4.6%
10	81.8	-3.4%	9.3%
11	83.1	3.3%	9.7%
12	85.8	5.6%	3.3%
13	85.6	6.2%	-12.8%
14	61.7	-1.9%	-19.0%
15	79.7	-3.3%	-12.9%
16	78.1	-7.9%	-10.6%

3000K (2K4K) | Rf: 90.2 | Rg: 101.4

Color Vector Graphic

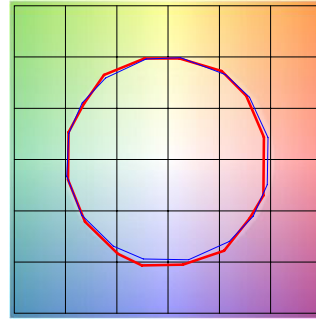

■ Test ■ Reference

HUE BIN	Rf	GRAPHIC SHIFTS %	
		CHROMA	HUE
1	90.9	-3.8%	1.3%
2	91.7	-1.9%	3.3%
3	88.7	0.7%	5.1%
4	92.4	-1.0%	0.7%
5	92.9	0.9%	1.7%
6	93.1	3.3%	-0.6%
7	91.0	-1.8%	-0.4%
8	97.0	0.2%	-1.1%
9	92.8	-0.5%	3.6%
10	88.3	1.0%	7.0%
11	87.1	3.8%	7.8%
12	87.6	6.5%	-0.3%
13	89.3	3.6%	-6.3%
14	86.1	4.5%	-9.1%
15	91.6	-1.9%	-3.1%
16	83.8	-1.5%	-11.2%

4000K ONLY (2K4K) | Rf: 89.6 | Rg: 99.1

Color Vector Graphic

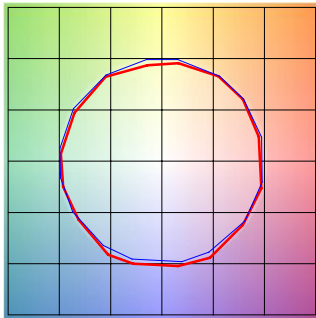

■ Test ■ Reference

HUE BIN	Rf	GRAPHIC SHIFTS %	
		CHROMA	HUE
1	91.3	-2.5%	1.0%
2	95.3	-0.5%	0.5%
3	94.3	-0.7%	1.1%
4	91.1	-3.4%	-1.1%
5	89.5	-5.6%	0.0%
6	94.6	-1.4%	1.3%
7	93.2	-3.0%	2.6%
8	91.3	-1.8%	4.6%
9	86.5	-0.9%	9.1%
10	83.3	-0.5%	9.5%
11	83.3	4.9%	9.0%
12	89.7	4.1%	1.7%
13	90.1	3.6%	-4.3%
14	93.4	5.2%	-2.1%
15	87.4	0.4%	-4.3%
16	86.6	0.4%	-6.1%

PROJECT	FIXTURE TYPE	DATE
---------	--------------	------

TIE STIX LED SUSPENSION

DYNAMIC/TUNABLE WHITE CENTER FEED DIRECT DOWN LIGHT

FJ-SCO-1-PN

Fast Jack Scope LED
9W, 315 lumens 3000K
(adjustable beam spread
from 20°-50°)

Fixture Finishes: SN, PN, BZ, WH

FJ-PST-SP-1-30K-SN

Fast Jack Piston
9W, 650 lumens
SP 15°, NF 25°, FL 35°
& WF 45° Beam Spreads
Fixture Finishes: SN, WH

FJ-FOR-SQ-3-PN

FJ-FOR-RD-3-PN
Fast Jack Form Round or Square
Fixture Finishes: SN, PN



FJ-FOR-2RD-3-SN

FJ-FOR-2SQ-3-SN
Fast Jack Form
Round or Square 2-Head
Fixture Finishes: SN, PN

FJ-REB-1-PN

Fast Jack Rebel

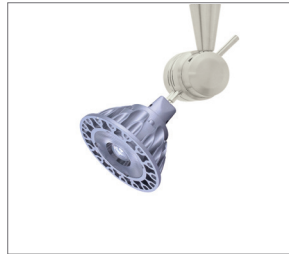
Fixture Finishes: SN, PN, BZ, WH

FJ-CHO-1-SN

Fast Jack Chopper with LED

Fixture Finishes: SN, PN, BZ

FJ-SPI-3-PN with S1-PN

Fast Jack Spirit, S1 Shade

Fixture Finishes: SN, PN, BZ
S1 Shade Finishes: SN, PN, BZ, BK

FJ-LOW-1-SN with S1-SN

Fast Jack Low Rider, S1 Shade

Fixture Finishes: SN, PN, BZ
S1 Shade Finishes: SN, PN, BZ, BK

FAST JACK FIXTURE & SHADE FINISHES

SN	Satin Nickel	PN	Polished Nickel	BZ	Antique Bronze	WH	White	BK	Black
-----------	--------------	-----------	-----------------	-----------	----------------	-----------	-------	-----------	-------

PROJECT		FIXTURE TYPE		DATE	
---------	--	--------------	--	------	--

12VAC LED MR16

REV 06.24.20

SOL LIGHT WARM DIM

Brand	Ordering Code	Watts	CRI	R9	Beam Angle (Degrees)	Lamp Life (Hours)	CCT Warm Dim	Total Lumens	Lumens Per Watt	Voltage	Certification	Halogen Equivalent
	MR16-12V-8W-NF-27KWD-SL	8	97+	85	24	30,000	2700K dims to 1800K	390	50	12V	Title 24 Compliant, low flicker <1% CE, UL, NOM	50
	MR16-12V-8W-FL-27KWD-SL	8	97+	85	36	30,000	2700K dims to 1800K	427	55	12V	Title 24 Compliant, low flicker <1% CE, UL, NOM	50
	MR16-12V-8W-NF-30KWD-SL	8	97+	85	24	30,000	3000K dims to 1800K	410	53	12V	Title 24 Compliant, low flicker <1% CE, UL, NOM	50
	MR16-12V-8W-FL-30KWD-SL	8	97+	85	36	30,000	3000K dims to 1800K	450	58	12V	Title 24 Compliant, low flicker <1% CE, UL, NOM	50

SORAA BRILLIANT HIGH LUMEN 2700K COLOR TEMPERATURE

Brand	Ordering Code	Watts	CRI	R9	Beam Angle (Degrees)	Lamp Life (Hours)	CBCP	Total Lumens	Lumens Per Watt	Voltage	Certification	Halogen Equivalent
	SM16-07-10D-827-H1*	8	90	80	10	35,000	8,000	575	77	12V +/- 1.2V	Title 20 certification pending, UL/CUL Class 2 and non-Class 2, FCC Title 47 Part 15B, RoHS, CE	75
	SM16-07-25D-827-H1	8	90	80	25	35,000	3,710	600	80	12V +/- 1.2V	Title 20 certification pending, UL/CUL Class 2 and non-Class 2, FCC Title 47 Part 15B, RoHS, CE	75
	SM16-07-36D-827-H1	8	90	80	36	35,000	1,550	600	80	12V +/- 1.2V	Title 20 certification pending, UL/CUL Class 2 and non-Class 2, FCC Title 47 Part 15B, RoHS, CE	75

*Use with Snap Lens

SORAA VIVID 2700K COLOR TEMPERATURE INDOOR/OUTDOOR

Brand	Ordering Code	Watts	CRI	R9	Beam Angle (Degrees)	Lamp Life (Hours)	CCT Warm Dim	Total Lumens	Lumens Per Watt	Voltage	Certification	Halogen Equivalent
	SM16-07-10d-927-03*	8	95	95	10	35,000	5,710	390	52	12V +/- 1.2V	JA8-2016-E, UL/CUL Class 2 and non-Class 2, FCC Title 47 Part 15B, RoHS, CE	50
	SM16-07-25D-927-03	8	95	95	25	35,000	2,260	410	55	12V +/- 1.2V	JA8-2016-E, UL/CUL Class 2 and non-Class 2, FCC Title 47 Part 15B, RoHS, CE	50
	SM16-07-36D-927-03	8	95	95	36	35,000	1,070	410	55	12V +/- 1.2V	JA8-2016-E, UL/CUL Class 2 and non-Class 2, FCC Title 47 Part 15B, RoHS, CE	50

*Use with Snap Lens

SORAA HEALTHY

Brand	Ordering Code	Watts	CRI	R9	Beam Angle (Degrees)	Lamp Life (Hours)	CCT Warm Dim	Total Lumens	Lumens Per Watt	Voltage	Certification	Halogen Equivalent
	SH-MR16-07-36D-27-01-X2	8	80	90	36	25,000	1,020	400	53	12V +/- 1.2V	UL/CUL, FCC Title 47 Part 15B, RoHS	50

SORAA BRILLIANT HIGH LUMEN 3000K COLOR TEMPERATURE

Brand	Ordering Code	Watts	CRI	R9	Beam Angle (Degrees)	Lamp Life (Hours)	CBCP	Total Lumens	Lumens Per Watt	Voltage	Certification	Halogen Equivalent
	SM16-07-10D-830-H1*	8	90	80	10	35,000	8,400	600	80	12V +/- 1.2V	Title 20 certification pending, UL/CUL Class 2 and non-Class 2, FCC Title 47 Part 15B, RoHS, CE	75
	SM16-07-25D-830-H1	8	90	80	25	35,000	3,300	630	84	12V +/- 1.2V	Title 20 certification pending, UL/CUL Class 2 and non-Class 2, FCC Title 47 Part 15B, RoHS, CE	75
	SM16-07-36D-830-H1	8	90	80	36	35,000	1,650	630	84	12V +/- 1.2V	Title 20 certification pending, UL/CUL Class 2 and non-Class 2, FCC Title 47 Part 15B, RoHS, CE	75

*Use with Snap Lens

PROJECT		FIXTURE TYPE		DATE	
---------	--	--------------	--	------	--

12VAC LED MR16

REV 06.24.20

SORAA VIVID 3000K COLOR TEMPERATURE MR16 INDOOR/OUTDOOR

Brand	Ordering Code	Watts	CRI	R9	Beam Angle (Degrees)	Lamp Life (Hours)	CCT Warm Dim	Total Lumens	Lumens Per Watt	Voltage	Certification	Halogen Equivalent
	SM16-07-10D-930-03*	8	95	95	10	35,000	6,000	410	55	12V +/- 1.2V	JA8-2016-E, UL/CUL Class 2 and non-Class 2, FCC Title 47 Part 15B, RoHS, CE	50
	SM16-07-25D-930-03	8	95	95	25	35,000	2,400	435	58	12V +/- 1.2V	JA8-2016-E, UL/CUL Class 2 and non-Class 2, FCC Title 47 Part 15B, RoHS, CE	50
	SM16-07-36D-930-03	8	95	95	36	35,000	1,130	435	58	12V +/- 1.2V	JA8-2016-E, UL/CUL Class 2 and non-Class 2, FCC Title 47 Part 15B, RoHS, CE	50

*Use with Snap Lens

SORAA VIVID 4000K COLOR TEMPERATURE MR16 INDOOR/OUTDOOR

Brand	Ordering Code	Watts	CRI	R9	Beam Angle (Degrees)	Lamp Life (Hours)	CBCP	Total Lumens	Lumens Per Watt	Voltage	Certification	Halogen Equivalent
	SM16-07-10D-940-03*	8	95	95	10	35,000	6,290	430	57	12V +/- 1.2V	JA8-2016-E, UL/CUL Class 2 and non-Class 2, FCC Title 47 Part 15B, RoHS, CE	50
	SM16-07-25D-940-03	8	95	95	25	35,000	2,510	455	61	12V +/- 1.2V	JA8-2016-E, UL/CUL Class 2 and non-Class 2, FCC Title 47 Part 15B, RoHS, CE	50
	SM16-07-36D-940-03	8	95	95	36	35,000	1,190	455	61	12V +/- 1.2V	JA8-2016-E, UL/CUL Class 2 and non-Class 2, FCC Title 47 Part 15B, RoHS, CE	50

*Use with Snap Lens

SATCO 3500K COLOR TEMPERATURE MR16 INDOOR/OUTDOOR

Brand	Ordering Code	Watts	CRI	R9	Beam Angle (Degrees)	Lamp Life (Hours)	CBCP	Total Lumens	Lumens Per Watt	Voltage	Certification	Halogen Equivalent
	S8637	8	90+	N/A	15	25,000	6,290	430	61	12	UL/CUL, FCC Title 47 Part 15B, RoHS, Lawful for sale in California	75
	S8642	8	90+	N/A	40	25,000	2,510	455	61	12	UL/CUL, FCC Title 47 Part 15B, RoHS, Lawful for sale in California	75

8MR16/LED/40/35K/90CRI/12V 8 watt; LED MR16; 3500K; 40° beam spread; GU5.3 base; 12 volts. Features: Silver back MR16 reflector. Direct replacements for 75 watt Halogen lamps - uses only 8 watts. Dimmable. No UV or IR radiation. Approved for enclosed fixtures.

PROJECT		FIXTURE TYPE		DATE	
---------	--	--------------	--	------	--

SORAA VIVID MR16 36° FL

3000K | Rf: 90.4 | Rg: 99.5

Color Vector Graphic

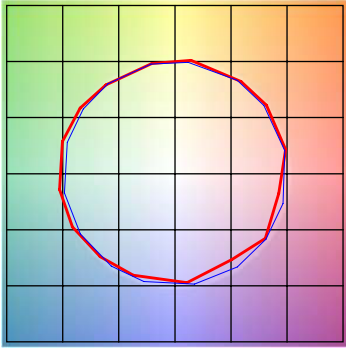

■ Test ■ Reference

HUE BIN	Rf	GRAPHIC SHIFTS %	
		CHROMA	HUE
1	94.4	1.0%	0.8%
2	94.6	2.1%	-1.1%
3	91.9	1.1%	-3.3%
4	91.9	2.1%	-2.1%
5	93.9	0.4%	-0.9%
6	95.2	0%	1.9%
7	93.4	2.7%	-0.7%
8	92.7	4.2%	0.1%
9	90.5	3.6%	-3.9%
10	84.3	2.3%	-9.2%
11	81.3	2.3%	-12.7%
12	81.3	-3.6%	-10.3%
13	90.5	-2.5%	-6.2%
14	88.5	-8.2%	-0.4%
15	96.2	-1.0%	0.3%
16	86.6	-5.4%	8.2%

SOL-LIGHT WARM DIM MR16 36° FL

3000K | Rf: 94.2 | Rg: 101.2

Color Vector Graphic

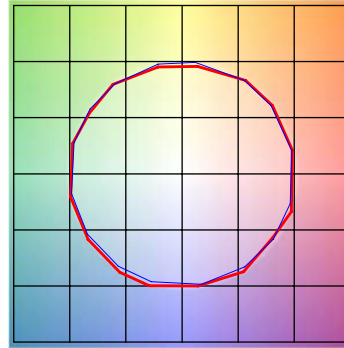

■ Test ■ Reference

HUE BIN	Rf	GRAPHIC SHIFTS %	
		CHROMA	HUE
1	96.0	0.3%	0.7%
2	96.8	0.9%	-0.8%
3	95.6	0.5%	-0.8%
4	93.1	-3.2%	-2.7%
5	95.7	-2.4%	0.4%
6	96.8	0.4%	1.6%
7	92.4	-1.4%	3.5%
8	96.8	1.2%	1.2%
9	94.0	1.4%	3.1%
10	92.6	2.1%	3.9%
11	92.2	3.7%	3.9%
12	92.4	3.9%	-0.9%
13	94.7	0.9%	-3.3%
14	93.4	3.0%	-3.2%
15	93.6	-1.1%	0.9%
16	90.2	2.4%	-6.7%

SORAA VIVID MR16 25° NFL

3000K | Rf: 94.0 | Rg: 101.0

Color Vector Graphic

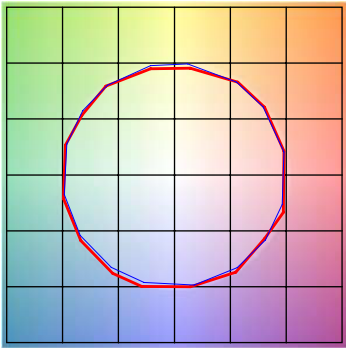

■ Test ■ Reference

HUE BIN	Rf	GRAPHIC SHIFTS %	
		CHROMA	HUE
1	95.9	0.3%	0.8%
2	96.8	0.8%	-0.9%
3	95.5	0.4%	-0.9%
4	92.7	-3.4%	-2.9%
5	95.6	-2.7%	0.4%
6	96.8	0.1%	1.6%
7	92.2	-1.6%	3.7%
8	96.6	1.1%	1.5%
9	93.7	1.4%	3.3%
10	92.4	2.2%	4.1%
11	92.2	3.8%	3.8%
12	92.4	3.9%	-1.1%
13	94.4	0.8%	-3.6%
14	93.3	2.8%	-3.4%
15	93.4	-1.4%	0.9%
16	90.3	2.2%	-6.7%

SOL-LIGHT WARM DIM MR16 24° NFL

3000K | Rf: 94.2 | Rg: 101.2

Color Vector Graphic

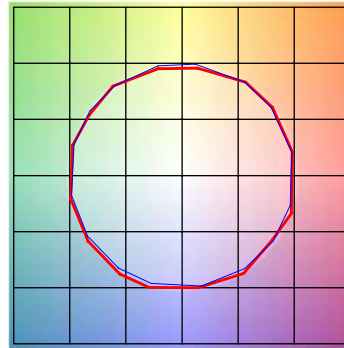

■ Test ■ Reference

HUE BIN	Rf	GRAPHIC SHIFTS %	
		CHROMA	HUE
1	95.9	0.3%	0.8%
2	96.8	0.8%	-0.9%
3	95.5	0.4%	-0.9%
4	92.7	-3.4%	-2.9%
5	95.6	-2.7%	0.4%
6	96.8	0.1%	1.6%
7	92.2	-1.6%	3.7%
8	96.6	1.1%	1.5%
9	93.7	1.4%	3.3%
10	92.4	2.2%	4.1%
11	92.2	3.8%	3.8%
12	92.4	3.9%	-1.1%
13	94.4	0.8%	-3.6%
14	93.3	2.8%	-3.4%
15	93.4	-1.4%	0.9%
16	90.3	2.2%	-6.7%

PROJECT	FIXTURE TYPE	DATE
---------	--------------	------