

DESCRIPTION

Verge Wall, a slim, plaster-in aluminum channel with a 4" paintable aluminum backer plate, highlights the transition where two drywall surfaces join together, while emitting ambient illumination. The 24VDC linear LED system mounts directly to studs without joist modification and plasters into 5/8" or thicker drywall. Verge is sold in 1' increments up to 40' and field cuttable to any length. Several color temperature options are available, including 2200K-5700K (**ELV/010**), Warm Dim (**ELV**), Tunable White (**ELV/010/DMX**), RGB and RGB+W (**DMX**). High CRI commercial-grade White or Dynamic Color Changing LED Soft Strip projects a clean line of light. Coordinate installation with electrical and drywall contractors. Includes a 5-year pro-rated warranty. For custom quotes and layout assistance, send drawings to design@PureEdgeLighting.com.

DESIGN NOTE

Verge Wall may be installed on a single surface for Toe-Kick and Cove lighting applications. Ambient and harmonious, the plaster-in LED system blends into 5/8" thick drywall to enhance the contemporary aesthetic of interior spaces. Verge offers unsurpassed flexibility that transforms interiors into thoughtful, unique works of art.

APPLICATIONS

Indoor damp or dry locations only. Wall Mount for use as Cove lighting or use at the Floor for Floating Wall effects. Ideal applications include Residential, Commercial, Retail, and Hospitality environments.

INCLUDED COMPONENTS

Junction Box, Adjustable Mounting Bars, Backer Plate, Verge Wall Channel(s), Drywall Screws, LED Soft Strip, and Lens(es)

LAMP

The average LED Life is 50,000 hours.

DESCRIPTION	2WDC						
WATTS PER FOOT	2.5w (2.5 watts)						
COLOR TEMPERATURE	22K	24K	27K	30K	35K	40K	57K
LUMENS PER FOOT (lm/ft)	90	100	110	120	137	149	159
LUMENS PER WATT (lm/w)	36	40	44	48	55	60	64
CRI	85+	95+	95+	95+	85+	85+	85+

DESCRIPTION	5WDC								
WATTS PER FOOT	5w (4.4 watts)								
COLOR TEMPERATURE	22K	24K	27K	27D*	30K	30D*	35K	40K	57K
LUMENS PER FOOT (lm/ft)	155	173	189	176	207	193	237	257	274
LUMENS PER WATT (lm/w)	35	39	43	40	47	44	54	59	62
CRI	85+	95+	95+	92+	95+	92+	85+	85+	85+

Lumen values are based on the 3000K LED test.

REMOTE POWER SUPPLIES*, DIMMERS & CONTROLS (SOLD SEPARATELY)

- Universal Power Supply, TRIAC, ELV and 0-10V flicker free dimming, Title 24
- Lutron Hi-Lume®
- Electronic Low Voltage Dimming (**ELV**)†
- Dynamic Color Changing (**DMX**)

*In-Wall Mounting Kits available for select power supplies

†With N-Lite Dimming Do Not use ELV power supply's, use only Uni drivers power supplies

COMPLIANCE

Title 24, ETL, Class 2, Damp Location, Made in USA. 1-hour fire rating uses Two pieces of Type X Gypsum board, for 2-Hour fire rating use Three pieces of Type X Gypsum board.

System	Watts Per Foot	Length in Feet	Color Temperature
VG VG Verge Wall	2WDC 2WDC 2.5 Watts (40' Max) 3WDC 2.6 Watts (36' Max) 5WDC 4.4 Watts (20' Max) 6WDC 6.3 Watts (16' Max)	1-40FT 1-40FT (2WDC) 1-36FT (3WDC) 1-20FT (5WDC) 1-16FT (6WDC)	27K 20K 2000K Sunset White 22K 2200K Candle White 24K 2400K Very Warm White 27K 2700K Incandescent White 27D 2700K Warm Dim (5WDC Only) 30K 3000K Warm White (Halogen) 30D 3000K Warm Dim (Halogen, 5WDC Only) 35K 3500K Neutral White 40K 4000K Cool White 57K 5700K Daylight White 2K4K 2000K-4000K Tunable White (5WDC only) RGB Red, Green, and Blue (3WDC + 5WDC only) RGBW Red, Green, Blue, and 2000K White (6WDC only)

PROJECT	FIXTURE TYPE	DATE

INCLUDED COMPONENTS

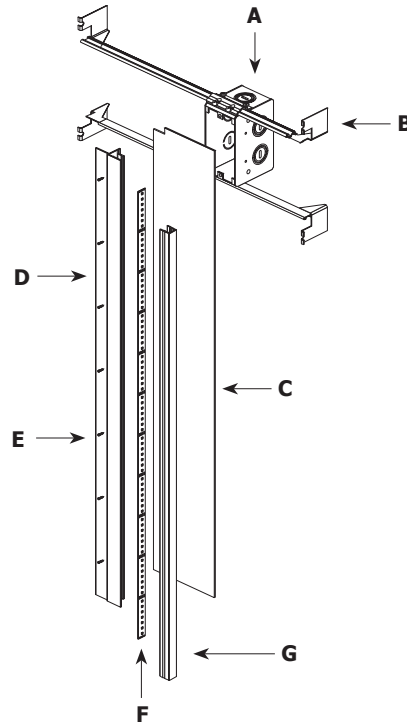

A. JUNCTION BOX

Mounts behind drywall with Adjustable Mounting Bars. Low Voltage 24VDC wires from Remote Power Supply connect to LED wires inside box. Junction Box opening is covered by the Backer Plate and required at the beginning of each run.

B. ADJUSTABLE MOUNTING BARS

Provide flexibility for mounting in a variety of spaces.

C. BACKER PLATE

4" paintable aluminum plate that conceals Junction Box and reflects light.

D. VERGE CHANNEL

5/8" deep extrusion houses a single row of LED Soft Strip.

E. DRYWALL SCREWS

Secures channel to drywall and stud.

F. LED SOFT STRIP

Commercial-grade White or Dynamic Color Changing LED Soft Strip. See lamp data on for additional details.

G. LENS

0.6" wide diffuser lens projects a clean line of light without LED dots.

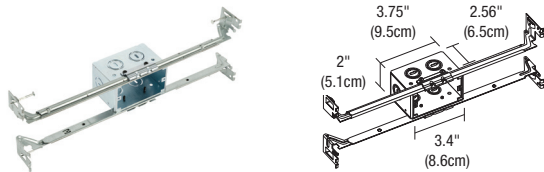

JUNCTION BOX ROUGH-IN COMPONENT

One Junction Box is included with Verge Wall. Order additional Junction Box(es) separately to rough-in electrical wiring before drywall installation. Quick shipment available.

System	Size	Component
VG	1RE	JBOX
<small>VG Verge Wall</small>	<small>1RE 1" Rectangle</small>	<small>JBOX Junction Box</small>
<small>*For RGB+W use VG-1RE-JBOX-RGBW</small>		

PROJECT	FIXTURE TYPE	DATE
---------	--------------	------

INSTALLATION

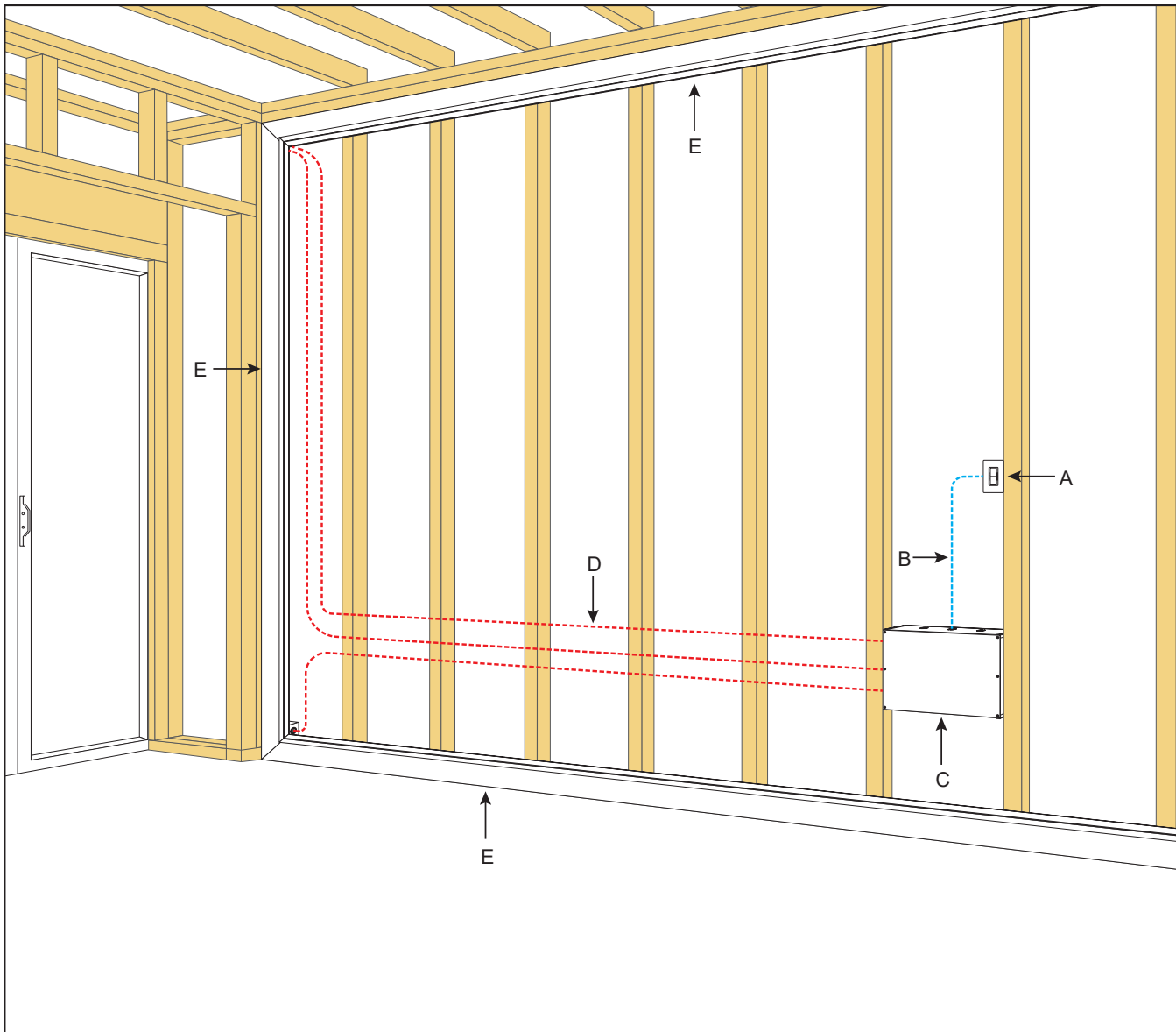

- A. DIMMER OR SWITCH**
- B. 120VAC WIRING**
- C. 120V/24VDC REMOTE POWER SUPPLY FOR IN-WALL MOUNTING KIT**
- D. 24VDC, CLASS 2 WIRING**
- E. VERGE WALL CHANNEL**

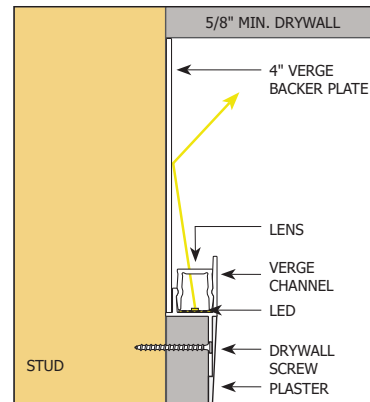

Direction of Light Cove Installation

PROJECT	FIXTURE TYPE	DATE
---------	--------------	------

2.5 WATTS PER FOOT - 22K, 27K, 30K, 35K, 40K AND 57K WHITE LEDS

LENGTH IN FEET	WATTS	LENGTH IN FEET	WATTS	LENGTH IN FEET	WATTS	LENGTH IN FEET	WATTS
1	3	11	27	21	51	31	75
2	5	12	29	22	54	32	78
3	8	13	32	23	56	33	80
4	10	14	34	24	58	34	82
5	13	15	37	25	61	35	85
6	15	16	39	26	63	36	87
7	17	17	41	27	66	37	90
8	20	18	44	28	68	38	92
9	22	19	46	29	70	39	94
10	25	20	48	30	73	40	96

5 WATTS PER FOOT - 22K, 27K, 27D, 30K, 30D, 35K, 40K AND 57K WHITE LEDS

LENGTH IN FEET	WATTS	LENGTH IN FEET	WATTS	LENGTH IN FEET	WATTS	LENGTH IN FEET	WATTS
1	5	6	29	11	53	16	77
2	10	7	34	12	58	17	82
3	14	8	38	13	63	18	87
4	19	9	43	14	67	19	91
5	24	10	48	15	72	20	96

3 WATTS PER FOOT - RGB LEDS

LENGTH IN FEET	WATTS	LENGTH IN FEET	WATTS	LENGTH IN FEET	WATTS	LENGTH IN FEET	WATTS
1	3	10	26	19	50	28	73
2	6	11	29	20	52	29	76
3	8	12	32	21	55	30	78
4	11	13	34	22	58	31	81
5	13	14	37	23	60	32	84
6	16	15	39	24	63	33	86
7	19	16	42	25	65	34	89
8	21	17	45	26	68	35	91
9	24	18	47	27	71		

6 WATTS PER FOOT - RGB+W LEDS

LENGTH IN FEET	WATTS	LENGTH IN FEET	WATTS	LENGTH IN FEET	WATTS	LENGTH IN FEET	WATTS
1	6	5	30	9	54	13	78
2	12	6	36	10	60	14	84
3	18	7	42	11	66	15	90
4	24	8	48	12	72	16	96

5 WATTS PER FOOT - 2K4K TUNABLE WHITE LEDS

LENGTH IN FEET	2K WATTS	4K WATTS	LENGTH IN FEET	2K WATTS	4K WATTS	LENGTH IN FEET	2K WATTS	4K WATTS
1	3	3	8	20	20	15	36	36
2	5	5	9	22	22	16	39	39
3	8	8	10	24	24	17	41	41
4	10	10	11	27	27	18	44	44
5	12	12	12	29	29	19	46	46
6	15	15	13	32	32	20	48	48
7	17	17	14	34	34			

PROJECT		FIXTURE TYPE		DATE	
---------	--	--------------	--	------	--

CEILING TM30 DATA

PLASTER-IN LED SYSTEM

TM-30-15 DATA: The data below is for SS5C and SS10C bare LED Soft Strips. Consistent color temperatures throughout a single strip and among multiple strips is possible through a 3 phase binning process in which each order is inspected with a color meter to ensure uniformity.

2200K | Rf: 83.9 | Rg: 94.9

Color Vector Graphic

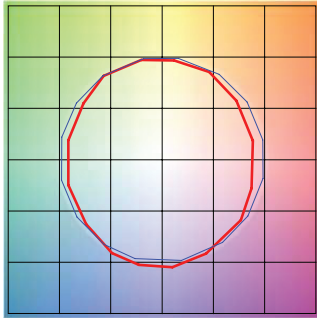

■ Test ■ Reference

GRAPHIC SHIFTS %			
HUE BIN	Rf	CHROMA	HUE
1	78.8	-9.5%	1.3%
2	80.7	-7.8%	6.7%
3	78.2	-3.3%	9.4%
4	89.7	-2.8%	3.6%
5	93.2	-0.8%	2.6%
6	93.0	-0.6%	-0.7%
7	87.7	-5.9%	-3.5%
8	89.2	-6.8%	1.9%
9	83.4	-5.6%	6.0%
10	79.3	-3.7%	10.8%
11	81.4	2.9%	11.1%
12	84.9	5.3%	4.9%
13	88.1	4.9%	-10.1%
14	68.1	0.1%	-19.5%
15	86.0	-3.3%	-7.3%
16	76.4	-8.9%	-11.7%

2400K | Rf: 91.2 | Rg: 96.8

Color Vector Graphic

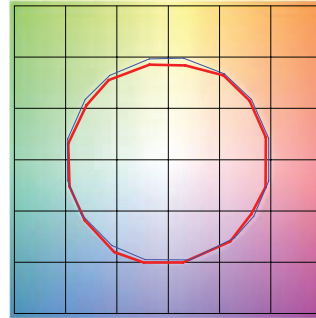

■ Test ■ Reference

GRAPHIC SHIFTS %			
HUE BIN	Rf	CHROMA	HUE
1	92.0	-2.4%	1.5%
2	94.7	-2.1%	0.0%
3	95.4	-1.9%	-0.1%
4	88.7	-6.7%	-3.1%
5	92.8	-5.6%	1.0%
6	92.7	-3.4%	3.4%
7	89.9	-4.3%	4.1%
8	92.4	-1.4%	4.4%
9	89.0	-0.6%	5.8%
10	88.9	0.4%	6.2%
11	89.7	4.0%	5.4%
12	92.6	3.0%	-0.7%
13	90.9	1.1%	-7.0%
14	89.9	0.5%	-5.8%
15	92.1	-3.2%	0.1%
16	88.9	-1.7%	-6.3%

2700K | Rf: 87.7 | Rg: 96.1

Color Vector Graphic

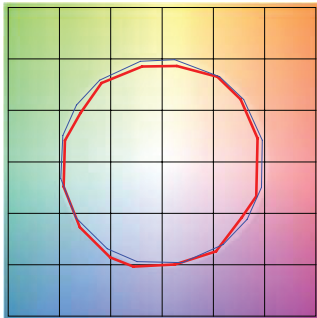

■ Test ■ Reference

GRAPHIC SHIFTS %			
HUE BIN	Rf	CHROMA	HUE
1	88.0	-4.3%	2.6%
2	91.6	-2.4%	2.0%
3	93.7	-1.4%	1.9%
4	88.9	-5.6%	-3.1%
5	92.3	-5.5%	-0.5%
6	92.9	-3.5%	0.1%
7	84.5	-7.5%	4.6%
8	90.8	-3.0%	4.4%
9	84.5	-1.3%	8.3%
10	83.9	2.0%	9.8%
11	87.2	5.3%	7.1%
12	89.2	5.4%	-2.6%
13	88.7	0.3%	-7.8%
14	86.8	1.7%	-9.3%
15	87.6	-5.4%	-1.3%
16	83.6	-3.3%	-9.5%

3000K | Rf: 88.1 | Rg: 99.7

Color Vector Graphic

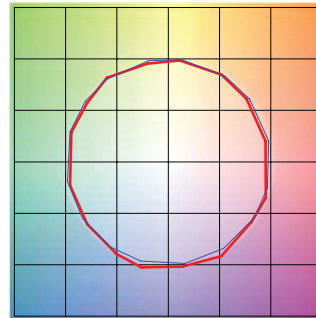

■ Test ■ Reference

GRAPHIC SHIFTS %			
HUE BIN	Rf	CHROMA	HUE
1	92.5	-3.1%	0.3%
2	93.3	-2.3%	1.9%
3	90.9	-0.8%	3.9%
4	94.3	-1.1%	1.4%
5	92.5	-2.6%	1.5%
6	96.4	1.2%	-0.3%
7	92.6	-2.5%	-0.0%
8	96.9	-1.4%	0.2%
9	92.3	-1.8%	4.3%
10	86.6	-0.7%	7.0%
11	86.5	2.4%	8.2%
12	89.8	5.9%	1.7%
13	93.9	2.6%	-2.7%
14	89.4	5.1%	-5.8%
15	90.1	-0.1%	-4.7%
16	86.5	0.3%	-9.7%

3500K | Rf: 86.1 | Rg: 95.5

Color Vector Graphic

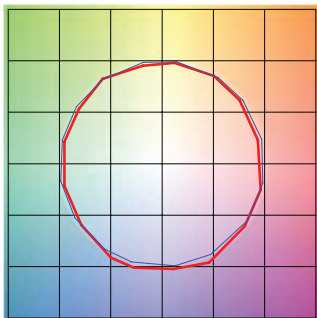

■ Test ■ Reference

GRAPHIC SHIFTS %			
HUE BIN	Rf	CHROMA	HUE
1	90.8	-3.8%	0.3%
2	92.3	-2.8%	2.1%
3	89.7	-1.0%	4.3%
4	92.6	-1.4%	1.7%
5	91.8	-3.1%	1.3%
6	96.2	0.8%	-0.4%
7	92.9	-3.2%	0.2%
8	94.3	-2.5%	1.5%
9	90.4	-2.5%	5.2%
10	84.3	-1.4%	9.5%
11	83.1	3.5%	9.8%
12	88.2	4.8%	3.4%
13	94.0	2.7%	-2.0%
14	88.7	5.9%	-5.8%
15	88.7	0.7%	-5.9%
16	86.8	-0.7%	-6.7%

4000K | Rf: 87.6 | Rg: 96.8

Color Vector Graphic

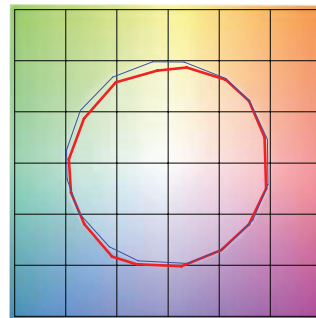

■ Test ■ Reference

GRAPHIC SHIFTS %			
HUE BIN	Rf	CHROMA	HUE
1	88.9	-2.4%	2.5%
2	93.3	-0.4%	0.8%
3	94.8	-1.0%	-0.6%
4	87.9	-4.9%	-3.6%
5	85.3	-9.4%	-2.6%
6	90.2	-6.0%	0.2%
7	85.3	-7.6%	4.6%
8	83.7	-4.1%	8.2%
9	79.5	-1.1%	13.8%
10	78.6	1.5%	12.1%
11	83.5	6.4%	7.8%
12	90.9	3.6%	-1.1%
13	88.3	1.7%	-6.3%
14	91.9	-0.4%	-2.2%
15	84.5	-0.9%	-5.5%
16	84.7	-1.1%	-4.4%

PROJECT	FIXTURE TYPE	DATE
---------	--------------	------

CEILING TM30 DATA

PLASTER-IN LED SYSTEM

TM-30-15 DATA: The data below is for SS5C and SS10C bare LED Soft Strips. Consistent color temperatures throughout a single strip and among multiple strips is possible through a 3 phase binning process in which each order is inspected with a color meter to ensure uniformity.

5700K | Rf: 80.3 | Rg: 91.5

Color Vector Graphic

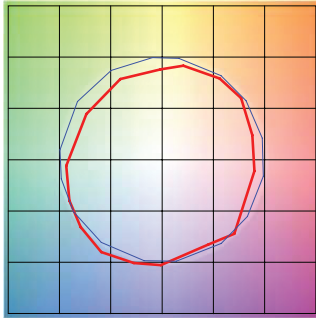

■ Test ■ Reference

HUE BIN	Rf	GRAPHIC SHIFTS %	
		CHROMA	HUE
1	75.4	-8.9%	4.7%
2	87.5	-2.6%	4.6%
3	90.7	-3.0%	-0.5%
4	83.2	-6.0%	-5.7%
5	76.2	-12.9%	-5.3%
6	81.4	-11.9%	-2.6%
7	74.8	-14.0%	5.1%
8	69.0	-9.0%	14.1%
9	72.6	-3.6%	22.2%
10	71.4	2.7%	16.1%
11	81.3	7.9%	5.3%
12	83.6	4.1%	-9.4%
13	78.4	0.7%	-15.3%
14	77.7	-6.2%	-11.0%
15	68.8	-1.3%	-21.2%
16	80.8	-9.6%	3.3%

2700D | Rf: 89.5 | Rg: 100.8

Color Vector Graphic

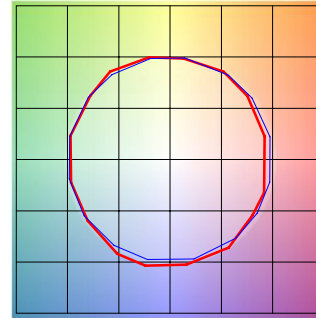

■ Test ■ Reference

HUE BIN	Rf	GRAPHIC SHIFTS %	
		CHROMA	HUE
1	88.8	-5.1%	1.4%
2	89.8	-2.7%	4.1%
3	87.2	0.3%	5.9%
4	92.3	-0.9%	1.0%
5	93.3	1.5%	1.7%
6	92.4	3.6%	-0.2%
7	92.2	-0.9%	-2.4%
8	96.7	-0.4%	-1.1%
9	92.3	-1.2%	3.7%
10	88.9	-0.0%	6.1%
11	86.4	5.1%	7.4%
12	88.2	6.3%	-0.9%
13	87.2	3.8%	-8.1%
14	84.2	3.8%	-11.0%
15	89.8	-2.6%	-4.3%
16	82.7	-3.4%	-11.1%

3000D | Rf: 89.8 | Rg: 101.4

Color Vector Graphic

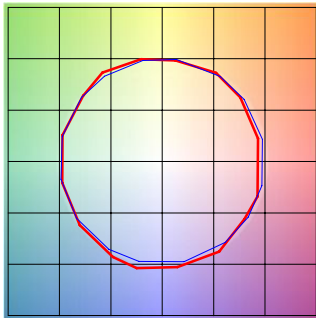

■ Test ■ Reference

HUE BIN	Rf	GRAPHIC SHIFTS %	
		CHROMA	HUE
1	90.2	-4.2%	1.5%
2	90.9	-2.0%	3.7%
3	87.9	0.8%	5.5%
4	92.1	-0.9%	0.6%
5	93.0	1.5%	1.6%
6	92.2	3.9%	-0.2%
7	92.1	-0.3%	-2.0%
8	96.7	0.0%	-1.2%
9	92.5	-0.6%	3.7%
10	88.3	1.1%	7.0%
11	87.2	4.1%	7.4%
12	87.2	6.7%	-1.0%
13	88.2	3.8%	-7.2%
14	85.3	4.3%	-9.9%
15	90.9	-2.2%	-3.6%
16	83.4	-2.2%	-11.2%

2000K ONLY (2K4K) | Rf: 84.3 | Rg: 96.9

Color Vector Graphic

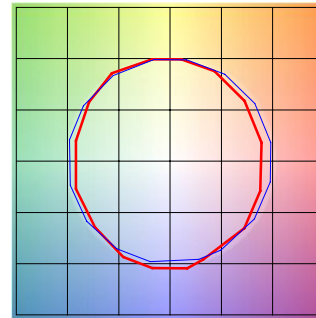

■ Test ■ Reference

HUE BIN	Rf	GRAPHIC SHIFTS %	
		CHROMA	HUE
1	80.3	-8.9%	1.7%
2	79.7	-7.0%	7.8%
3	78.9	-2.9%	10.0%
4	89.5	-0.5%	5.1%
5	94.4	0.7%	1.7%
6	92.1	2.4%	-0.3%
7	89.4	-2.4%	-5.9%
8	89.7	-6.4%	-0.2%
9	86.0	-4.9%	4.6%
10	81.8	-3.4%	9.3%
11	83.1	3.3%	9.7%
12	85.8	5.6%	3.3%
13	85.6	6.2%	-12.8%
14	61.7	-1.9%	-19.0%
15	79.7	-3.3%	-12.9%
16	78.1	-7.9%	-10.6%

4000K ONLY (2K4K) | Rf: 89.6 | Rg: 99.1

Color Vector Graphic

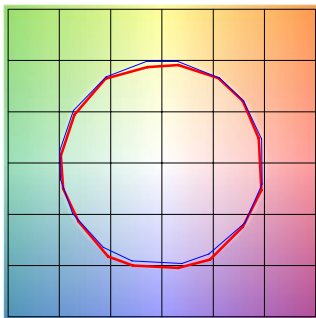

■ Test ■ Reference

HUE BIN	Rf	GRAPHIC SHIFTS %	
		CHROMA	HUE
1	91.3	-2.5%	1.0%
2	95.3	-0.5%	0.5%
3	94.3	-0.7%	1.1%
4	91.1	-3.4%	-1.1%
5	89.5	-5.6%	0.0%
6	94.6	-1.4%	1.3%
7	93.2	-3.0%	2.6%
8	91.3	-1.8%	4.6%
9	86.5	-0.9%	9.1%
10	83.3	-0.5%	9.5%
11	83.3	4.9%	9.0%
12	89.7	4.1%	1.7%
13	90.1	3.6%	-4.3%
14	93.4	5.2%	-2.1%
15	87.4	0.4%	-4.3%
16	86.6	0.4%	-6.1%

2K4K (3000K) | Rf: 90.2 | Rg: 101.4

Color Vector Graphic

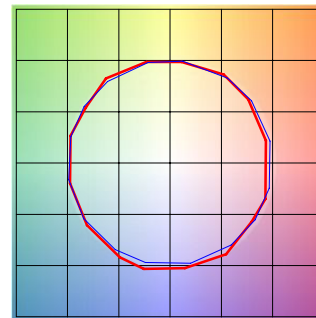

■ Test ■ Reference

HUE BIN	Rf	GRAPHIC SHIFTS %	
		CHROMA	HUE
1	90.9	-3.8%	1.3%
2	91.7	-1.9%	3.3%
3	88.7	0.7%	5.1%
4	92.4	-1.0%	0.7%
5	92.9	0.9%	1.7%
6	93.1	3.3%	-0.6%
7	91.0	-1.8%	-0.4%
8	97.0	0.2%	-1.1%
9	92.8	-0.5%	3.6%
10	88.3	1.0%	7.0%
11	87.1	3.8%	7.8%
12	87.6	6.5%	-0.3%
13	89.3	3.6%	-6.3%
14	86.1	4.5%	-9.1%
15	91.6	-1.9%	-3.1%
16	83.8	-1.5%	-11.2%

PROJECT	FIXTURE TYPE	DATE
---------	--------------	------