

# VERGE WALL/FLOOR 24VDC - PLASTER-IN LED SYSTEM

REV.09.20.18

DESIGNED BY GREGORY KAY | ASSEMBLED IN AMERICA

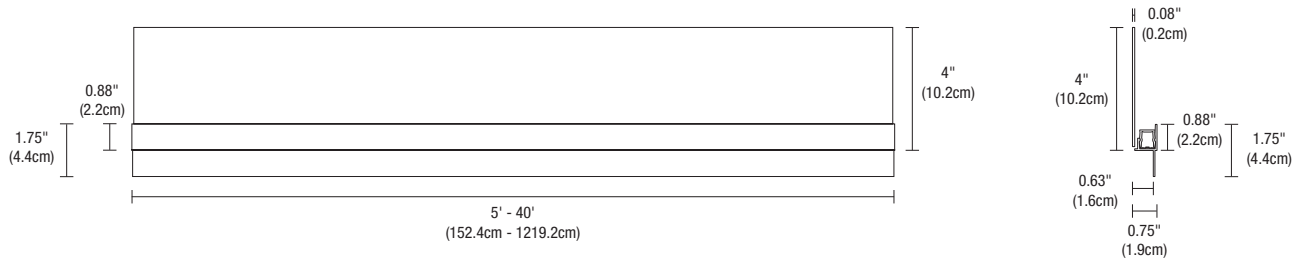

## DESCRIPTION

Verge Wall/Floor, a slim, plaster-in aluminum channel with a 4" paintable aluminum backer plate highlights the transition where two drywall surfaces verge together, while emitting ambient illumination. The 24VDC linear LED system mounts directly to studs without joist modification and plasters into 5/8" or thicker drywall. Verge is sold in 5' increments up to 40' and field cuttable to any length. Several color temperature options are available, including 2200K-5700K (ELV/010), Warm Dim (ELV), Tunable White (ELV/010/DMX), RGB and RGB+W (DMX). High CRI commercial-grade White or Dynamic Color Changing LED Soft Strip projects a clean line of light. Coordinate installation with electrician and drywall contractors. Includes a 5 year pro-rated warranty.

## DESIGN NOTE

Verge Wall/Floor may be installed on a single surface for Toe-Kick and Cove lighting applications. Ambient and harmonious, the plaster-in LED system blends into 5/8" thick drywall to enhance the contemporary aesthetic of interior spaces. Verge offers unsurpassed flexibility that transforms interiors into thoughtful, unique works of art.

## APPLICATIONS

Indoor damp or dry locations only. A Wall Mount for use as Cove lighting or use at the Floor for Floating Wall effects, for Hospitality, Retail, and Residential

## LAMP

The average LED Life is 50,000 hours.

WATTS PER FOOT	LUMENS		CRI				RGB	RGB+W
	PER WATT	PER FOOT	85+	90+	92+	95+		
2WDC (2.5WDC)	57	186	•			•		
3WDC	N/A	N/A				•		
5WDC	N/A	N/A	•	•	•	•		
6WDC	N/A	N/A					•	

Lumen values are based on the 3000K LED test.

## REMOTE POWER SUPPLIES\*, DIMMERS & CONTROLS (SOLD SEPARATELY)

- Electronic Low Voltage Dimming (ELV)
  - 0-10 Volt Dimming (0-10V)
  - Dynamic Color Changing (DMX)
- \*In-Wall Mounting Kits available for select power supplies

## INCLUDED COMPONENTS

Junction Box, Adjustable Mounting Bars, Backer Plate, Verge Wall Channel(s), Drywall Screws, LED Soft Strip, and Lens(es)

System	Watts Per Foot	Length in Feet	Color Temperature
<b>VG</b> Verge Wall/Floor	<b>2WDC</b> 2.5 Watts 3WDC 3 Watts (35' Max) 5WDC 5 Watts (20' Max) 6WDC 6 Watts (15' Max)	<b>10FT</b> 5FT 5' 10FT 10' 15FT 15' 20FT 20' 25FT 25' 30FT 30' 35FT 35' 40FT 40'	<b>27K</b> 22K 2200K Amber White 27K 2700K Very Warm White 27D 2700K Warm Dim (5WDC Only) 30K 3000K Warm White 30D 3000K Warm Dim (5WDC Only) 35K 3500K Neutral White 40K 4000K Cool White 57K 5700K Daylight White 2K4K 2000K - 4000K Tunable White (5WDC only) RGB Red, Green, and Blue (3WDC only) RGBW Red, Green, Blue, and 2000K White (6WDC only)

For custom design and layout assistance, send drawings to [design@PureEdgeLighting.com](mailto:design@PureEdgeLighting.com)

PROJECT	FIXTURE TYPE	DATE
---------	--------------	------

# VERGE WALL/FLOOR 24VDC - PLASTER-IN LED SYSTEM

REV.09.20.18

DESIGNED BY GREGORY KAY | ASSEMBLED IN AMERICA

## INCLUDED COMPONENTS

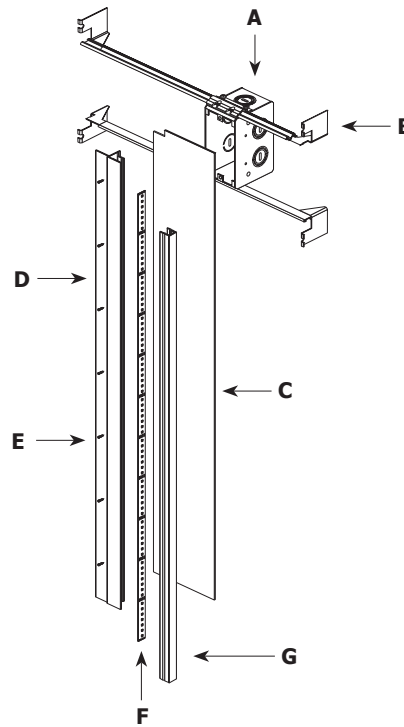

### A. JUNCTION BOX

Mounts behind drywall with Adjustable Mounting Bars. Low Voltage 24VDC wires from Remote Power Supply connect to LED wires inside box. Junction Box opening is covered by the Backer Plate and required at the beginning of each run.

### B. ADJUSTABLE MOUNTING BARS

Provide flexibility for mounting in a variety of spaces.

### C. BACKER PLATE

4" paintable aluminum plate that conceals Junction Box and reflects light.

### D. VERGE CHANNEL

5/8" deep extrusion houses a single row of commercial-grade White or Dynamic Color Changing LED Soft Strip.

### E. DRYWALL SCREWS

Secures channel to drywall and stud.

### F. LED SOFT STRIP

Commercial-grade White or Dynamic Color Changing LED Soft Strip. See lamp data on for additional details.

### G. LENS

0.6" wide diffuser lens projects a clean line of light without LED dots.

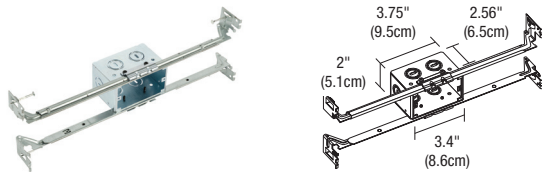

### JUNCTION BOX ROUGH-IN COMPONENT

One Junction Box is included with Verge Wall/Floor. Order additional Junction Box(es) separately to rough-in electrical wiring before drywall installation. Quick shipment available.

System	Size	Component
<b>VG</b>	<b>1RE</b>	<b>JBOX</b>
VG Verge Wall/Floor	1RE 1" Rectangle	JBOX Junction Box

PROJECT	FIXTURE TYPE	DATE
---------	--------------	------

# VERGE WALL/FLOOR 24VDC - PLASTER-IN LED SYSTEM

REV.09.20.18

DESIGNED BY GREGORY KAY | ASSEMBLED IN AMERICA

## INSTALLATION



- A. DIMMER OR SWITCH
- B. 120VAC WIRING
- C. 120V/24VDC REMOTE POWER SUPPLY FOR IN-WALL MOUNTING KIT
- D. 24VDC, CLASS 2 WIRING
- E. VERGE WALL CHANNEL
- F. LED SOFT STRIP

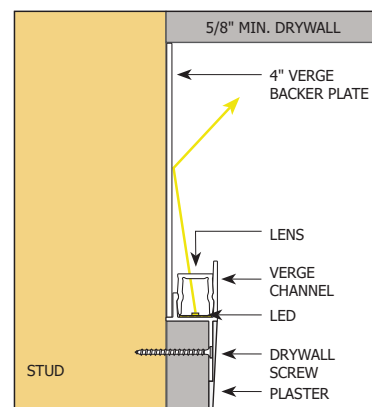

Direction of Light

PROJECT	FIXTURE TYPE	DATE

# VERGE WALL/FLOOR 24VDC - PLASTER-IN LED SYSTEM

REV.09.20.18

DESIGNED BY GREGORY KAY | ASSEMBLED IN AMERICA

- APPLICATION** 0-10V dimming for Verge Wall/Floor
- POWER SUPPLY** PSB-96W-010-24VDC (24VDC 96W output) | PSB-2X96W-010-24VDC (24VDC 2X96W output)
- DIMMING** Radio Ra2 (with GRX-TVI), Grafik Eye Qs (with GRX-TVI), Diva (with PP20); Nova T; Philips: Sunrise SR1200ZTUNV; Leviton: IP710-LF

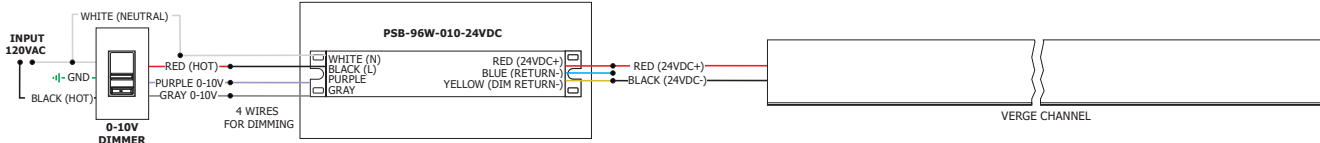

**2.5 WATTS PER FOOT - 22K, 27K, 30K, 35K, 40K AND 57K WHITE LEDS**

LENGTH IN FEET	WATTS	LENGTH IN FEET	WATTS	LENGTH IN FEET	WATTS	LENGTH IN FEET	WATTS
1	3	11	27	21	51	31	75
2	5	12	29	22	54	32	78
3	8	13	32	23	56	33	80
4	10	14	34	24	58	34	82
5	13	15	37	25	61	35	85
6	15	16	39	26	63	36	87
7	17	17	41	27	66	37	90
8	20	18	44	28	68	38	92
9	22	19	46	29	70	39	94
10	25	20	48	30	73	40	96

**5 WATTS PER FOOT - 22K, 27K, 27D, 30K, 30D, 35K, 40K AND 57K WHITE LEDS**

LENGTH IN FEET	WATTS	LENGTH IN FEET	WATTS	LENGTH IN FEET	WATTS	LENGTH IN FEET	WATTS
1	5	6	29	11	53	16	77
2	10	7	34	12	58	17	82
3	14	8	38	13	63	18	87
4	19	9	43	14	67	19	91
5	24	10	48	15	72	20	96

**3 WATTS PER FOOT - RGB LEDS**

LENGTH IN FEET	WATTS	LENGTH IN FEET	WATTS	LENGTH IN FEET	WATTS	LENGTH IN FEET	WATTS
1	3	10	26	19	50	28	73
2	6	11	29	20	52	29	76
3	8	12	32	21	55	30	78
4	11	13	34	22	58	31	81
5	13	14	37	23	60	32	84
6	16	15	39	24	63	33	86
7	19	16	42	25	65	34	89
8	21	17	45	26	68	35	91
9	24	18	47	27	71		

**6 WATTS PER FOOT - RGB+W LEDS**

LENGTH IN FEET	WATTS	LENGTH IN FEET	WATTS	LENGTH IN FEET	WATTS	LENGTH IN FEET	WATTS
1	6	5	30	9	54	13	78
2	12	6	36	10	60	14	84
3	18	7	42	11	66	15	90
4	24	8	48	12	72	16	96

**5 WATTS PER FOOT - 2K4K TUNABLE WHITE LEDS**

LENGTH IN FEET	2K WATTS	4K WATTS	LENGTH IN FEET	2K WATTS	4K WATTS	LENGTH IN FEET	2K WATTS	4K WATTS
1	3	3	8	20	20	15	36	36
2	5	5	9	22	22	16	39	39
3	8	8	10	24	24	17	41	41
4	10	10	11	27	27	18	44	44
5	12	12	12	29	29	19	46	46
6	15	15	13	32	32	20	48	48
7	17	17	14	34	34			

PROJECT		FIXTURE TYPE		DATE	
---------	--	--------------	--	------	--

# VERGE WALL/FLOOR 24VDC - PLASTER-IN LED SYSTEM

REV.09.20.18

DESIGNED BY GREGORY KAY | ASSEMBLED IN AMERICA

## TM-30-15 DATA

The data below is for SS2C and SS5C bare LED Soft Strips. Consistent color temperatures throughout a single strip and among multiple strips is possible through a 3 phase binning process in which each order is inspected with a color meter to ensure uniformity.

**2200K** | Rf: 83.9 | Rg: 94.9

Color Vector Graphic

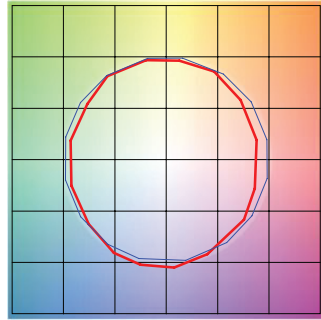

■ Test ■ Reference

HUE BIN	Rf	GRAPHIC SHIFTS %	
		CHROMA	HUE
1	77.6	-10.0%	1.8%
2	80.7	-7.5%	7.0%
3	79.5	-2.9%	8.9%
4	90.5	-3.1%	2.4%
5	93.9	-1.3%	1.9%
6	91.9	-0.9%	-0.2%
7	87.6	-6.3%	-2.7%
8	90.5	-5.4%	2.7%
9	83.8	-4.7%	6.5%
10	81.2	-2.5%	10.0%
11	83.3	3.9%	9.4%
12	86.4	5.6%	2.6%
13	86.2	4.5%	-12.4%
14	64.3	-1.0%	-21.9%
15	85.1	-4.4%	-7.5%
16	75.0	-9.9%	-12.0%

**2700K** | Rf: 87.7 | Rg: 96.1

Color Vector Graphic

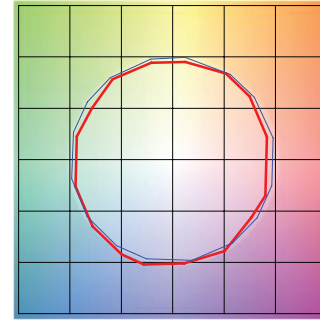

■ Test ■ Reference

HUE BIN	Rf	GRAPHIC SHIFTS %	
		CHROMA	HUE
1	86.4	-5.6%	2.3%
2	89.7	-3.3%	3.1%
3	90.5	-1.5%	3.8%
4	90.0	-4.3%	1.1%
5	92.9	-3.7%	0.2%
6	93.5	-2.5%	-0.8%
7	86.3	-7.2%	2.5%
8	90.7	-4.0%	3.2%
9	85.2	-2.4%	8.1%
10	81.7	0.9%	10.8%
11	85.4	4.5%	8.9%
12	88.7	5.7%	-1.4%
13	88.3	1.3%	-7.9%
14	85.1	2.4%	-10.4%
15	88.1	-4.8%	-2.7%
16	81.7	-4.3%	-10.9%

**3000K** | Rf: 88.1 | Rg: 99.7

Color Vector Graphic

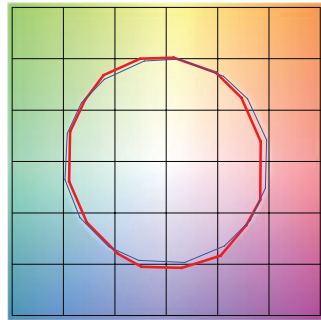

■ Test ■ Reference

HUE BIN	Rf	GRAPHIC SHIFTS %	
		CHROMA	HUE
1	87.7	-5.9%	-0.3%
2	87.9	-4.4%	4.3%
3	82.9	-1.2%	7.9%
4	89.9	0.6%	4.7%
5	92.7	3.0%	3.5%
6	92.7	3.6%	-1.7%
7	90.8	-1.3%	-4.4%
8	93.7	-2.5%	-2.2%
9	91.7	-3.7%	2.3%
10	85.5	-2.8%	7.8%
11	83.3	0.7%	11.0%
12	86.4	5.5%	3.8%
13	90.6	4.6%	-3.6%
14	85.6	5.9%	-8.4%
15	89.5	-0.6%	-5.7%
16	82.6	-2.7%	-12.0%

**3500K** | Rf: 86.1 | Rg: 95.5

Color Vector Graphic

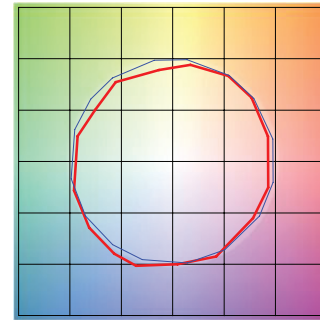

■ Test ■ Reference

HUE BIN	Rf	GRAPHIC SHIFTS %	
		CHROMA	HUE
1	86.6	-4.2%	3.4%
2	91.7	-1.4%	1.8%
3	94.9	-0.7%	0.4%
4	87.9	-4.5%	-4.1%
5	85.9	-10.3%	-2.7%
6	89.8	-5.2%	-0.4%
7	79.6	-9.5%	6.5%
8	87.6	-4.0%	5.7%
9	81.4	-0.5%	11.8%
10	78.3	3.3%	11.4%
11	85.7	6.3%	6.1%
12	86.3	7.1%	-4.6%
13	86.1	-0.7%	-9.6%
14	85.1	0.8%	-10.4%
15	83.4	-4.1%	-5.3%
16	82.5	-3.6%	-5.7%

**4000K** | Rf: 87.6 | Rg: 96.8

Color Vector Graphic

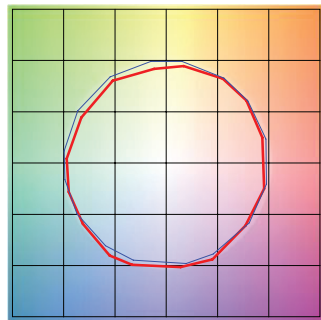

■ Test ■ Reference

HUE BIN	Rf	GRAPHIC SHIFTS %	
		CHROMA	HUE
1	89.0	-3.1%	2.1%
2	93.2	-0.9%	1.3%
3	94.3	-1.1%	0.7%
4	89.5	-4.0%	-2.3%
5	87.6	-7.8%	-1.8%
6	92.2	-4.6%	0.1%
7	87.4	-6.6%	3.6%
8	85.7	-3.8%	7.0%
9	81.5	-1.3%	12.4%
10	80.0	0.9%	11.4%
11	83.3	5.9%	8.7%
12	89.7	4.8%	-0.3%
13	88.5	2.4%	-6.3%
14	92.7	4.0%	-3.8%
15	86.1	-1.6%	-4.5%
16	85.0	-1.4%	-5.0%

**5700K** | Rf: 80.3 | Rg: 91.5

Color Vector Graphic

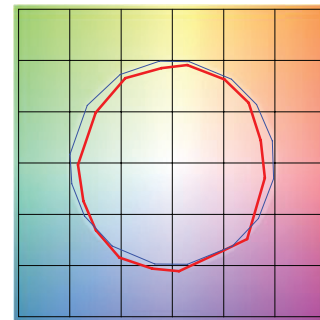

■ Test ■ Reference

HUE BIN	Rf	GRAPHIC SHIFTS %	
		CHROMA	HUE
1	73.8	-11.2%	2.6%
2	83.7	-5.5%	5.8%
3	84.2	-4.0%	5.5%
4	85.8	-3.5%	1.3%
5	85.3	-7.1%	0.6%
6	89.2	-5.8%	-2.2%
7	81.5	-10.7%	1.2%
8	75.7	-9.7%	8.5%
9	74.9	-7.8%	18.8%
10	67.8	-1.6%	18.0%
11	76.1	5.5%	12.0%
12	90.8	4.9%	-1.6%
13	83.6	5.0%	-9.5%
14	81.7	-1.2%	-10.0%
15	69.0	2.0%	-22.8%
16	83.2	-8.5%	-1.0%

PROJECT		FIXTURE TYPE		DATE	
---------	--	--------------	--	------	--

# VERGE WALL/FLOOR 24VDC - PLASTER-IN LED SYSTEM

REV.09.20.18

DESIGNED BY GREGORY KAY | ASSEMBLED IN AMERICA

## TM-30-15 DATA

The data below is for SS2C and SS5C bare LED Soft Strips. Consistent color temperatures throughout a single strip and among multiple strips is possible through a 3 phase binning process in which each order is inspected with a color meter to ensure uniformity.

**2700D** | Rf: 89.5 | Rg: 100.8

Color Vector Graphic

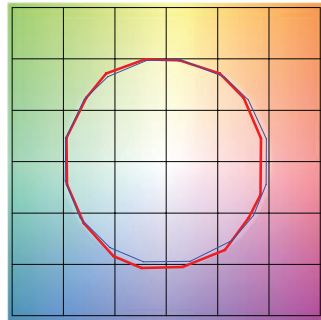

■ Test ■ Reference

HUE BIN	Rf	GRAPHIC SHIFTS %	
		CHROMA	HUE
1	88.8	-5.1%	1.4%
2	89.8	-2.7%	4.1%
3	87.2	0.3%	5.9%
4	92.3	-0.9%	1.0%
5	93.3	1.5%	1.7%
6	92.4	3.6%	-0.2%
7	92.2	-0.9%	-2.4%
8	96.7	-0.4%	-1.1%
9	92.3	-1.2%	3.7%
10	88.9	-0.0%	6.1%
11	86.4	5.1%	7.4%
12	88.2	6.3%	-0.9%
13	87.2	3.8%	-8.1%
14	84.2	3.8%	-11.0%
15	89.8	-2.6%	-4.3%
16	82.7	-3.4%	-11.1%

**3000D** | Rf: 89.8 | Rg: 101.4

Color Vector Graphic

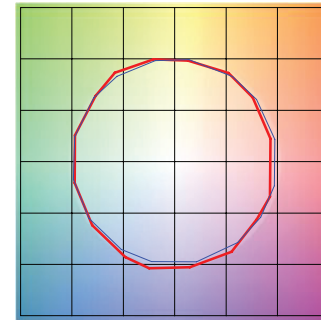

■ Test ■ Reference

HUE BIN	Rf	GRAPHIC SHIFTS %	
		CHROMA	HUE
1	90.2	-4.2%	1.5%
2	90.9	-2.0%	3.7%
3	87.9	0.8%	5.5%
4	92.1	-0.9%	0.6%
5	93.0	1.5%	1.6%
6	92.2	3.9%	-0.2%
7	92.1	-0.3%	-2.0%
8	96.7	0.0%	-1.2%
9	92.5	-0.6%	3.7%
10	88.3	1.1%	7.0%
11	87.2	4.1%	7.4%
12	87.2	6.7%	-1.0%
13	88.2	3.8%	-7.2%
14	85.3	4.3%	-9.9%
15	90.9	-2.2%	-3.6%
16	83.4	-2.2%	-11.2%

**2000K ONLY (2K4K)** | Rf: 84.3 | Rg: 96.9

Color Vector Graphic

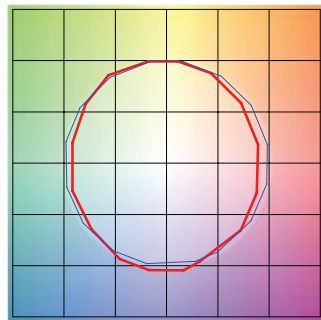

■ Test ■ Reference

HUE BIN	Rf	GRAPHIC SHIFTS %	
		CHROMA	HUE
1	80.3	-8.9%	1.7%
2	79.7	-7.0%	7.8%
3	78.9	-2.9%	10.0%
4	89.5	-0.5%	5.1%
5	94.4	0.7%	1.7%
6	92.1	2.4%	-0.3%
7	89.4	-2.4%	-5.9%
8	89.7	-6.4%	-0.2%
9	86.0	-4.9%	4.6%
10	81.8	-3.4%	9.3%
11	83.1	3.3%	9.7%
12	85.8	5.6%	3.3%
13	85.6	6.2%	-12.8%
14	61.7	-1.9%	-19.0%
15	79.7	-3.3%	-12.9%
16	78.1	-7.9%	-10.6%

**4000K ONLY (2K4K)** | Rf: 89.6 | Rg: 99.1

Color Vector Graphic

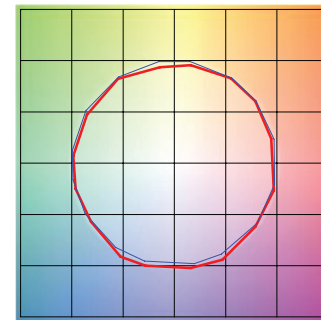

■ Test ■ Reference

HUE BIN	Rf	GRAPHIC SHIFTS %	
		CHROMA	HUE
1	91.3	-2.5%	1.0%
2	95.3	-0.5%	0.5%
3	94.3	-0.7%	1.1%
4	91.1	-3.4%	-1.1%
5	89.5	-5.6%	0.0%
6	94.6	-1.4%	1.3%
7	93.2	-3.0%	2.6%
8	91.3	-1.8%	4.6%
9	86.5	-0.9%	9.1%
10	83.3	-0.5%	9.5%
11	83.3	4.9%	9.0%
12	89.7	4.1%	1.7%
13	90.1	3.6%	-4.3%
14	93.4	5.2%	-2.1%
15	87.4	0.4%	-4.3%
16	86.6	0.4%	-6.1%

**2K4K (3000K)** | Rf: 90.2 | Rg: 101.4

Color Vector Graphic

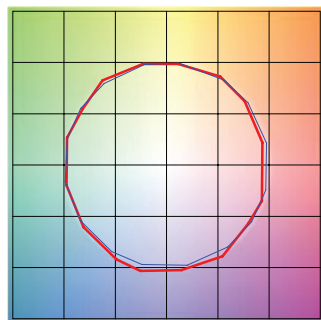

■ Test ■ Reference

HUE BIN	Rf	GRAPHIC SHIFTS %	
		CHROMA	HUE
1	90.9	-3.8%	1.3%
2	91.7	-1.9%	3.3%
3	88.7	0.7%	5.1%
4	92.4	-1.0%	0.7%
5	92.9	0.9%	1.7%
6	93.1	3.3%	-0.6%
7	91.0	-1.8%	-0.4%
8	97.0	0.2%	-1.1%
9	92.8	-0.5%	3.6%
10	88.3	1.0%	7.0%
11	87.1	3.8%	7.8%
12	87.6	6.5%	-0.3%
13	89.3	3.6%	-6.3%
14	86.1	4.5%	-9.1%
15	91.6	-1.9%	-3.1%
16	83.8	-1.5%	-11.2%

PROJECT		FIXTURE TYPE		DATE	
---------	--	--------------	--	------	--