

# 1x1 MULTIPLES

## TRIMMED

LED

5 YEAR WARRANTY

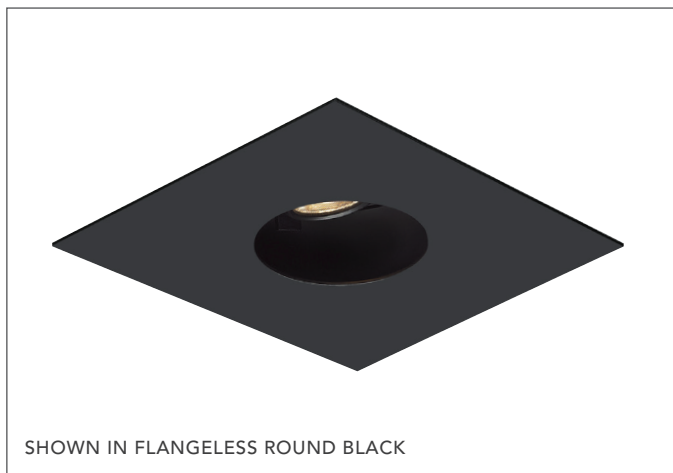

SHOWN IN FLANGELESS ROUND BLACK

ELEMENT MULTIPLES FEATURE A UNIQUE PATENT-PENDING LED SPOT MODULE ENABLING REMARKABLE TOOL-FREE ADJUSTMENT AND LOCKING WHILE MAINTAINING FULL CENTER BEAM CANDLE POWER AT ALL TILT & ROTATION ANGLES. ALL TRIMS ARE MADE OF COLD ROLLED STEEL FOR EXCELLENT DURABILITY AND ARE AVAILABLE IN SEVERAL FINISHES, CEILING APPEARANCE AND APERTURE CONFIGURATIONS TO ACCOMMODATE VIRTUALLY ANY AESTHETIC. FLANGELESS HOUSINGS INCLUDE EXTRUDED AND PRECISION WELDED ALUMINUM PLASTER PLATES. FLANGED HOUSINGS INCLUDE A COLOR MATCHED COLD ROLLED STEEL CEILING FLANGE. ALSO AVAILABLE IN 1X2, 1X3, 1X4 AND 2X2 CONFIGURATIONS.

	TRIMMED	OPEN
<b>HOUSINGS</b>		
Ratings	IC (Low Output Only), Non-IC, Chicago Plenum	
Ceiling Appearance	Flanged or Flangeless	
Sizes	1x1, 1x2, 1x3, 1x4, 2x2	
Power Consumption	Low: 12 watts per Light Module High: 18 watts per Light Module	
Finish	Black, White	
<b>TRIMS (Sold Separately)</b>		
Flanged Trim	Yes	N/A
Flangeless Trim	Yes	N/A
<b>LIGHT MODULES (Sold Separately)</b>		
CCT	2700K, 3000K, 3500K	
CRI	80, 90	
Adjustable Spot (40°)	1370 Delivered Lumens (per Module, High Output, 3000K) 1050 Delivered Lumens (per Module, Low Output, 3000K)	
Spot Optics	20°, 30°, 40°, or 60° (Optics are Field Changeable)	
General Illumination	N/A	1530 Delivered Lumens (per Module, High Output, 3000K) 1178 Delivered Lumens (per Module, Low Output, 3000K)
Wall Wash	N/A	1097 Delivered Lumens (per Module, High Output, 3000K) 892 Delivered Lumens (per Module, Low Output, 3000K)
Order housings, modules, and trims (if applicable) separately. Must order corresponding number of modules based on housing size (e.g. 3 modules for a 1x3 housing, 4 modules for a 2x2 housing).		

### HOUSING

- Constructed of heavy gauge cold rolled steel with durable black powder coat finish
- Low profile design for use in standard 2x6 construction
- Airtight and available in IC, Non-IC or Chicago Plenum
- Includes integrated junction box approved for branch circuit through wiring
- Accommodates up to 2" ceiling thickness
- ETL listed, Damp listed
- Available flanged or flangeless

### SPOT MODULE\*

- 35° tilt and 360° rotation with tool-free locking
- Field-changeable optic: 20°, 30°, 40°, 60°
- Fully contained and modular design for ease of install and maintenance
- 5"x 5" ceiling opening per spot module
- Standard finishes: Black or White powder coat
- Holds up to two optional lenses, ordered separately

### DRIVER & DIMMING

- Voltage options: 120v, 240v or 277v
- Driver efficiency: 83.4%
- Power factor: 0.98
- Dimming options: ELV or 0-10v
- Smooth dimming to 2%-15% depending on dimmer
- Driver ships with housing

Visit [www.element-lighting.com](http://www.element-lighting.com) for full photometrics. \* Consult Quotes Department for custom finish options

GENERATION BRANDS



2016 Tech Lighting, L.L.C. All rights reserved. The "Element" graphic is a registered trademark of Element. Element reserves the right to change specifications for product improvements without notification.

**ELEMENT**  
by Tech Lighting®

7400 Linder Avenue, Skokie, Illinois 60077 T 847.410.4400 F 847.410.4500

# 1x1 MULTIPLES

## TRIMMED

### TRIMS

#### ROUND

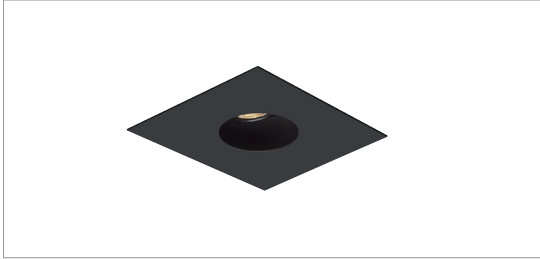

FLANGED

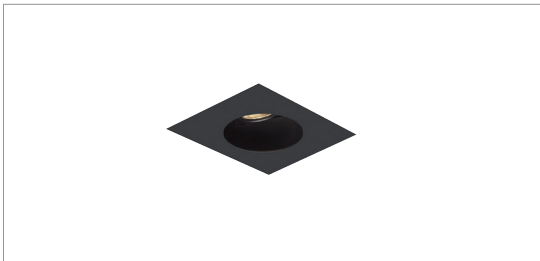

FLANGELESS

#### SQUARE

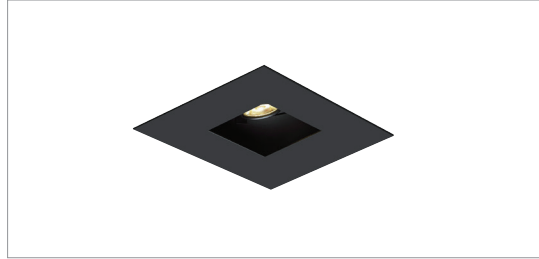

FLANGED

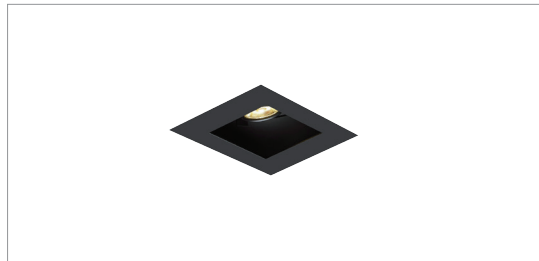

FLANGELESS

#### FINISH



BLACK



SATIN  
NICKEL



WHITE  
(PAINTABLE)

#### CEILING APPEARANCE

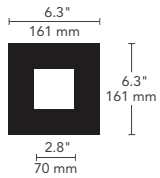

FLANGED

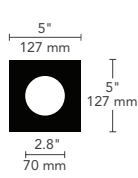

FLANGELESS

### HOUSING

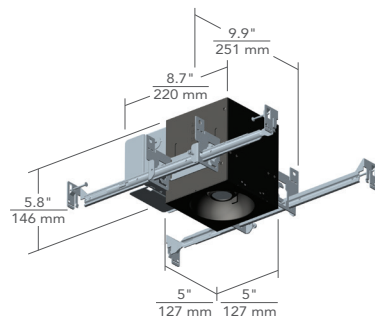

IC AIRTIGHT / NON-IC AIRTIGHT  
(MAX CEILING THICKNESS: 2")

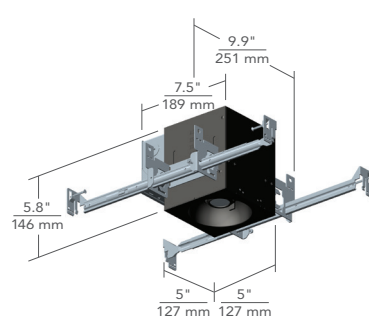

CHICAGO PLENUM  
(MAX CEILING THICKNESS: 2")

### SPOT MODULE

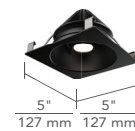

SPOT

# 1x1 MULTIPLES

## TRIMMED

### GRIDS

### HOUSING

ELEMENT MULTIPLES	SIZE	CEILING APPEARANCE	OUTPUT	HOUSING TYPE	VOLTAGE	DIMMING/DRIVER	FINISH
EMTH TRIMMED	11 1 X 1 SPOT	L FLANGELESS F FLANGED	LH HIGH OUTPUT LO LOW OUTPUT	I IC AIRTIGHT* N NON-IC AIRTIGHT C CHICAGO PLENUM	120 120 VOLT 277 277 VOLT	ELV LOW-VOLTAGE ELECTRONIC 010 0-10 VOLT	B BLACK W WHITE
EMTH	11						

MUST ORDER 1 LIGHT MODULE (SOLD SEPARATELY) \*LOW-OUTPUT ONLY

### LIGHT MODULES

MODULES	CRI	CCT	FUNCTION	FINISH
EMT TRIMMED APERTURE	8 80CRI 9 90CRI	27 2700K 30 3000K 35 3500K	A20 ADJUSTABLE - 20° OPTIC A30 ADJUSTABLE - 30° OPTIC A40 ADJUSTABLE - 40° OPTIC A60 ADJUSTABLE - 60° OPTIC	B BLACK W WHITE
EMT				

### TRIM

ELEMENT MULTIPLES	SPOTS	APERTURE OPENING	CEILING APPEARANCE	FINISH
EMT TRIMMED	11 1 X 1 SPOT	R ROUND S SQUARE	FF FLANGED LF FLANGELESS	-B BLACK -S SATIN NICKEL -W WHITE
EMT	11			-

### REPLACEMENT OPTIC

	BEAM SPREAD
351LEDGATOPT	20 20° 30 30° 40 40° 60 60°
351LEDGATOPT	

### LENSES / LOUVERS

	TYPE	FINISH
MOC	GG PLAIN GLASS LENS KIT SF SOFT FOCUS LENS KIT LL LINEAR SPREAD LENS KIT EC EGGCRATE LOUVER KIT LS1 1" LONG SNOOT LS12 1/2" LONG SNOOT	-B BLACK -W WHITE
MOC		-

## PROJECT INFO

FIXTURE TYPE

---



---

FIXTURE QUANTITY

---



---

JOB NAME

---



---

NOTES

---



---



# 1x1 MULTIPLES

## TRIMMED

### PHOTOMETRICS: HIGH OUTPUT

DESCRIPTION: LED Multiples  
30° Beam - 0° Tilt, 3000K  
MODEL: LED Multiples 30° High

INPUT POWER (WATTS): 18.7  
INPUT POWER FACTOR: 0.98  
ABSOLUTE LUMINOUS FLUX (LUMENS): 1114  
LUMEN EFFICACY (LUMENS PER WATT): 59.6

ANGLE	0°	45°	90°
0°	2770	2770	2770
5°	2582	2594	2624
10°	2101	2117	2177
15°	1458	1483	1539
20°	898	917	962
25°	509	519	549
30°	273	280	299
35°	148	153	165
40°	85	88	96
45°	53	56	61
50°	36	38	42
55°	25	26	30
60°	16	17	20
65°	9	10	11
70°	4	5	6
75°	0	0	1
80°	0	0	0
85°	0	0	0
90°	0	0	0

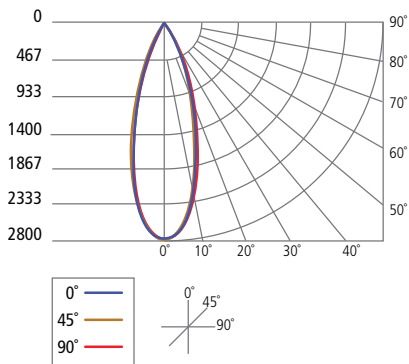
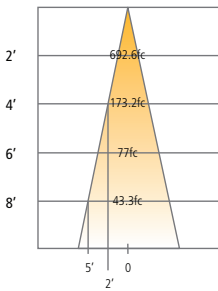

DESCRIPTION: LED Multiples  
40° Beam - 0° Tilt, 3000K  
MODEL: LED Multiples 40° High

INPUT POWER (WATTS): 18.7  
INPUT POWER FACTOR: 0.98  
ABSOLUTE LUMINOUS FLUX (LUMENS): 1371  
LUMEN EFFICACY (LUMENS PER WATT): 73.2

ANGLE	0°	45°	90°
0°	2854	2854	2854
5°	2743	2741	2757
10°	2445	2440	2478
15°	1962	1970	2006
20°	1344	1363	1414
25°	750	781	828
30°	368	385	414
35°	176	182	196
40°	88	90	94
45°	45	47	48
50°	25	25	27
55°	14	14	15
60°	8	8	9
65°	4	4	6
70°	1	1	2
75°	0	0	0
80°	0	0	0
85°	0	0	0
90°	0	0	0

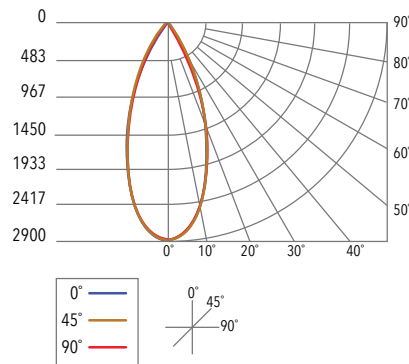
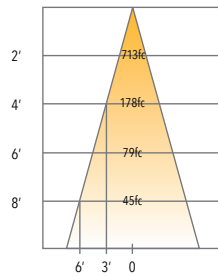

DESCRIPTION: LED Multiples  
20° Beam - 0° Tilt, 3000K  
MODEL: LED Multiples 20° High

INPUT POWER (WATTS): 18.7  
INPUT POWER FACTOR: 0.98  
ABSOLUTE LUMINOUS FLUX (LUMENS): 1271  
LUMEN EFFICACY (LUMENS PER WATT): 68

ANGLE	0°	45°	90°
0°	4179	4179	4179
5°	3539	3591	3744
10°	2488	2547	2772
15°	1614	1651	1773
20°	994	1017	1091
25°	550	570	619
30°	296	307	336
35°	163	171	184
40°	91	95	103
45°	51	52	58
50°	29	30	33
55°	17	18	19
60°	11	11	12
65°	5	6	7
70°	1	1	3
75°	0	0	0
80°	0	0	0
85°	0	0	0
90°	0	0	0

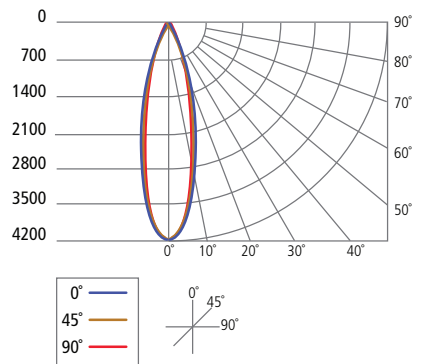
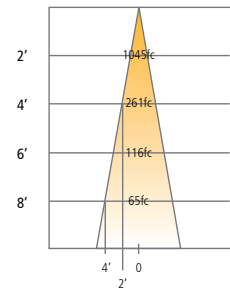

# 1x1 MULTIPLES

## TRIMMED

### PHOTOMETRICS: LOW OUTPUT

DESCRIPTION: LED Multiples  
30° Beam - 0° Tilt, 3000K  
MODEL: LED Multiples 30° Low

INPUT POWER (WATTS): 12.4  
INPUT POWER FACTOR: 0.98  
ABSOLUTE LUMINOUS FLUX (LUMENS): 860  
LUMEN EFFICACY (LUMENS PER WATT): 69.4

ANGLE	0°	45°	90°
0°	2156	2156	2156
5°	2087	2073	2030
10°	1775	1751	1670
15°	1295	1266	1177
20°	832	807	731
25°	486	472	421
30°	266	260	233
35°	144	142	130
40°	80	80	78
45°	49	50	49
50°	33	33	34
55°	22	23	24
60°	14	15	16
65°	9	9	9
70°	6	6	5
75°	2	2	1
80°	0	0	0
85°	0	0	0
90°	0	0	0

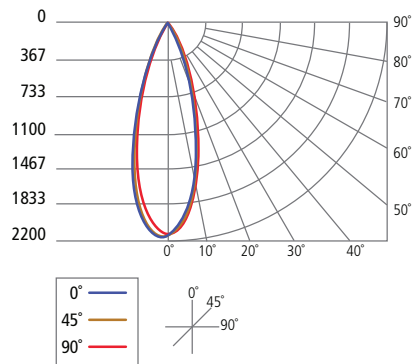
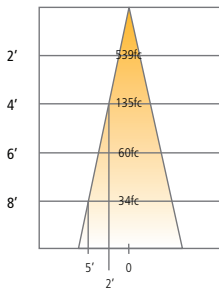

DESCRIPTION: LED Multiples  
40° Beam - 0° Tilt, 3000K  
MODEL: LED Multiples 40° Low

INPUT POWER (WATTS): 12.4  
INPUT POWER FACTOR: 0.98  
ABSOLUTE LUMINOUS FLUX (LUMENS): 1056  
LUMEN EFFICACY (LUMENS PER WATT): 85.2

ANGLE	0°	45°	90°
0°	2188	2188	2188
5°	2137	2136	2106
10°	1956	1938	1893
15°	1633	1608	1536
20°	1206	1175	1082
25°	736	705	632
30°	377	362	318
35°	179	174	151
40°	82	81	74
45°	42	42	39
50°	24	23	22
55°	14	13	12
60°	8	8	8
65°	5	5	5
70°	2	2	2
75°	1	0	0
80°	0	0	0
85°	0	0	0
90°	0	0	0

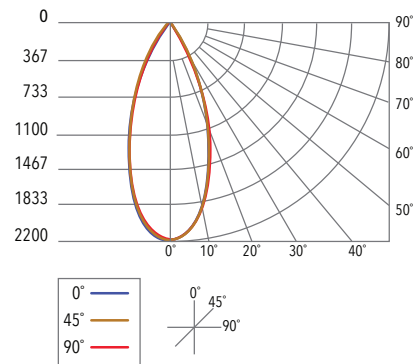
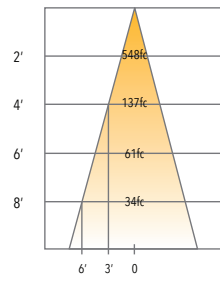

DESCRIPTION: LED Multiples  
20° Beam - 0° Tilt, 3000K  
MODEL: LED Multiples 20° Low

INPUT POWER (WATTS): 12.4  
INPUT POWER FACTOR: 0.98  
ABSOLUTE LUMINOUS FLUX (LUMENS): 984  
LUMEN EFFICACY (LUMENS PER WATT): 79.4

ANGLE	0°	45°	90°
0°	3210	3210	3210
5°	2929	2897	2822
10°	2118	2098	2046
15°	1383	1372	1331
20°	864	857	833
25°	498	498	479
30°	270	276	263
35°	151	154	147
40°	82	85	80
45°	44	45	44
50°	26	25	26
55°	15	15	15
60°	9	9	9
65°	6	6	6
70°	2	2	2
75°	0	0	0
80°	0	0	0
85°	0	0	0
90°	0	0	0

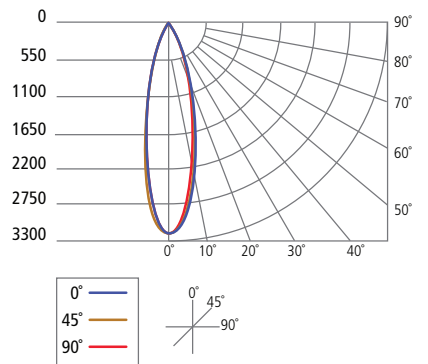
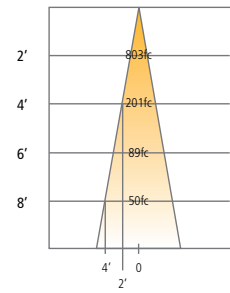

# 1x1 MULTIPLES

## TRIMMED

### PHOTOMETRICS: 60° OPTIC

DESCRIPTION: LED Multiples  
60° Beam - 0° Tilt, 3000K

MODEL: LED Multiples 60° High

INPUT POWER (WATTS): 21.1  
 INPUT POWER FACTOR: 0.98  
 ABSOLUTE LUMINOUS FLUX (LUMENS): 1401  
 LUMEN EFFICACY (LUMENS PER WATT): 66.4

DESCRIPTION: LED Multiples  
60° Beam - 0° Tilt, 3000K

MODEL: LED Multiples 60° Low

INPUT POWER (WATTS): 14.6  
 INPUT POWER FACTOR: 0.98  
 ABSOLUTE LUMINOUS FLUX (LUMENS): 1078  
 LUMEN EFFICACY (LUMENS PER WATT): 73.9

ANGLE	0°	45°	90°
0°	1435	1435	1435
5°	1422	1414	1404
10°	1356	1340	1327
15°	1241	1231	1206
20°	1091	1088	1047
25°	913	897	862
30°	707	679	655
35°	503	486	465
40°	340	332	315
45°	225	213	201
50°	137	130	119
55°	80	76	66
60°	43	41	35
65°	22	21	17
70°	8	7	6
75°	1	0	0
80°	0	0	0
85°	0	0	0
90°	0	0	0

ANGLE	0°	45°	90°
0°	1105	1105	1105
5°	1095	1089	1081
10°	1044	1032	1022
15°	955	948	929
20°	840	837	806
25°	703	691	664
30°	545	523	505
35°	388	374	358
40°	262	256	243
45°	173	164	154
50°	106	100	92
55°	61	58	51
60°	33	31	27
65°	17	16	13
70°	6	6	4
75°	0	0	0
80°	0	0	0
85°	0	0	0
90°	0	0	0

