

# 2" LED

## ADJUSTABLE DOWNLIGHT & WALL WASH

The ELEMENT 2" adjustable downlight boasts a 1.4" aperture and 2.75" ceiling cutout. Unique aiming/locking mechanism offers 0-45° tilt, 361° rotation, and ELEMENT's patented high-low lamp positioning. Flanged or flangeless (includes mud plate), round or square, flat or beveled die-cast trims in four finishes. Interchangeable optics: 20°, 30°, 40°, 60° and dedicated wall wash trims offer a full suite of installation solutions. Remodel installation also available with same performance and trim options. Suitable for use in .375"-2" ceiling thickness (Note: tilt restriction in thicker ceilings.)

- Hot aiming/locking mechanism offers 0-45° tilt, 361° rotation, and high-low lamp positioning
- Interchangeable optics: 20°, 30°, 40°, 60° and wall wash trim option
- Mechanism and junction box serviced through ceiling aperture
- Remodel installation also available with same performance and trim options

### SPECIFICATIONS

	HIGH OUTPUT (AT 3000K)		LOW OUTPUT (AT 3000K)		WARM DIM LOW OUTPUT
DELIVERED LUMENS	1565	1252	1163	930	850
WATTS	18.7	18.7	12.4	12.4	12
EFFICACY (L/W)	84	67	93	75	71
CRI	80+	90+	80+	90+	90+
CBCP	20° - 5136; 30° - 4644; 40° - 3050; 60° - 1764				
CCT OPTIONS	2700K, 3000K, 3500K, Warm Color Dimming (3000K-1800K)				
VOLTAGE	120V or 277V				
DIMMING*	TRIAC, ELV or 0-10V				
POWER SUPPLY	Constant Current driver with +.9 power factor and +80% efficiency				
OPTICS	20°, 30°, 40°, 60°, Wall Wash				
ADJUSTABILITY	0-45° tilt, 361° rotation, high-low lamp positioning				
CEILING APPEARANCE	Ceiling Mount: Flanged or Flangeless (Both accommodate 3/8" to 2" ceiling thickness. Note: tilt restricted in thicker ceilings, Not for use with T-Grid (Acoustic Tile). Housing Mount: T-Grid/Flanged (For up to 1 ceiling thickness max).				
CEILING APERTURE	2.75" ceiling cut-out				
HOUSING	IC Airtight, Non-IC Airtight, Chicago Plenum. IC suitable for insulation rating up to R60.				
CONSTRUCTION	Housing: Heavy gauge cold rolled steel Trims: Die-cast aluminum				
FINISH	Housing: Black powder coat Trims: Antique Bronze, Black, Satin Nickel, White (paintable)				
GENERAL LISTING	ETL listed. Damp listed. Shower version wet listed.				
CALIFORNIA TITLE 24	Registered CEC Appliance Database. Can be used to comply with CEC 2016 Title 24 Part 6 for 90 CRI versions.				
LED LIFETIME	L70; 50,000 hours				
WARRANTY**	5 Years				

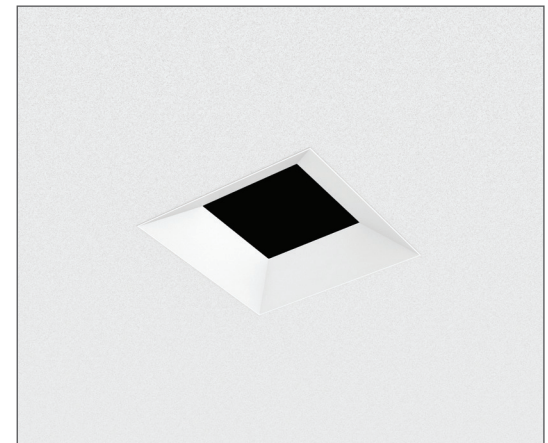

shown in flangeless bevel square

\*See ELEMENT-lighting.com for dimmer compatibility.  
\*\*Visit ELEMENT-lighting.com for specific warranty limitations and details.

TRIMS

ROUND

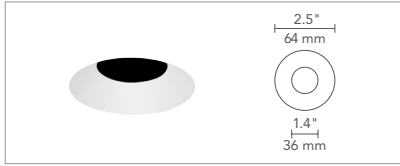

FLANGELESS BEVEL

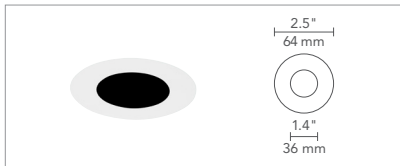

FLANGELESS FLAT

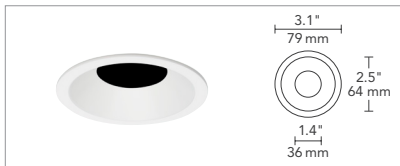

FLANGED BEVEL

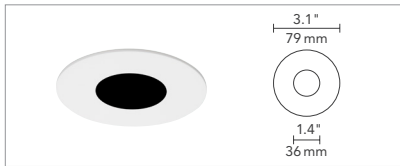

FLANGED FLAT

SQUARE

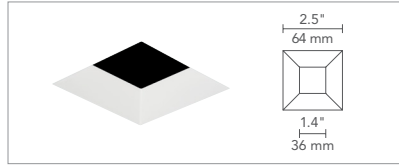

FLANGELESS BEVEL

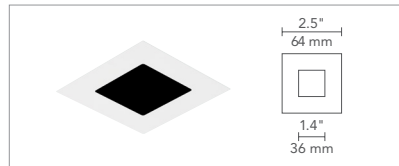

FLANGELESS FLAT

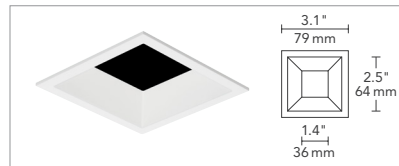

FLANGED BEVEL

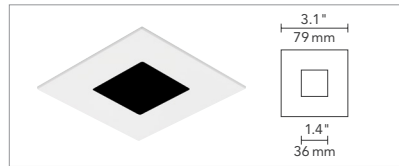

FLANGED FLAT

WALL WASH

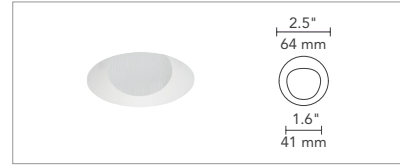

FLANGELESS WALL WASH

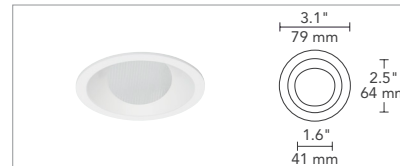

FLANGED WALL WASH

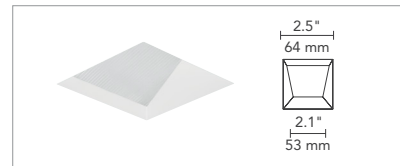

FLANGELESS WALL WASH



FLANGED WALL WASH

FINISH



ANTIQUE BRONZE



BLACK



SATIN NICKEL



WHITE (PAINTABLE)

2" HOUSING

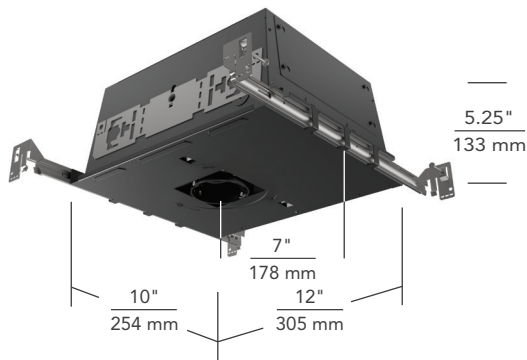

IC AIRTIGHT / CHICAGO PLENUM  
FLANGED/FLANGELESS CEILING MOUNT

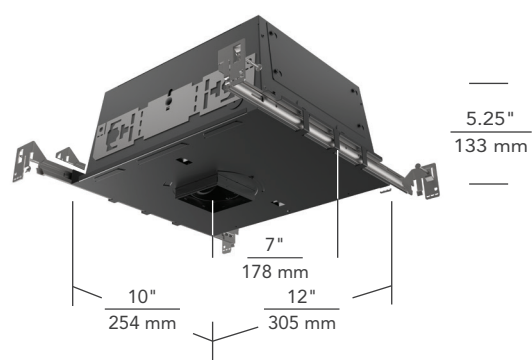

IC AIRTIGHT / CHICAGO PLENUM  
T-GRID FLANGED HOUSING MOUNT

### FLANGED/FLANGELESS - CEILING MOUNTED COLLAR

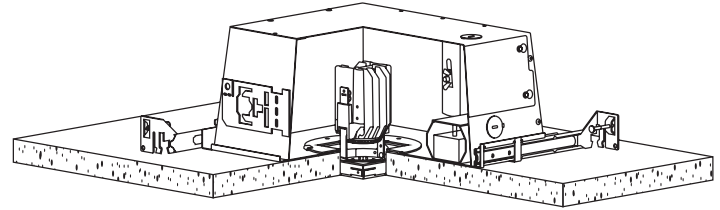
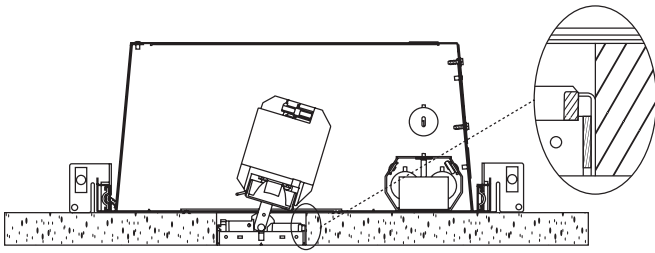

CEILING MOUNTED COLLAR

- FLANGED OR FLANGELESS
- COMPATIBLE WITH DRYWALL, WOOD
- NOT COMPATIBLE WITH T-GRID (ACOUSTIC TILE)
- OPTIMIZES LAMP POSITION REGARDLESS OF CEILING THICKNESS
- ALLOWS INSTALL IN UP TO 2.5" CEILING THICKNESS

### T-GRID/FLANGED - HOUSING MOUNTED COLLAR

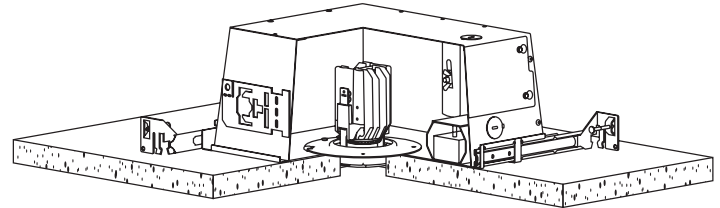
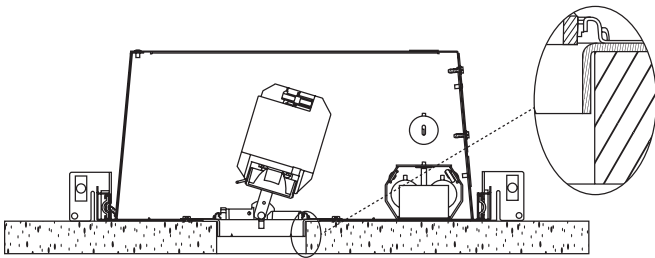

HOUSING MOUNTED COLLAR

- FLANGED ONLY
- COMPATIBLE WITH T-GRID (ACOUSTIC TILE), DRYWALL, WOOD
- FOR 1" CEILING THICKNESS MAX

When ordering the T-Grid/Flanged with Housing Mounted Collar, please order trim extender for ceiling thicknesses greater than 0.5" and for use up to 1" thickness (max). **Please consult instructions sheet.**

## GRIDS

### HOUSING

PRODUCT SERIES	CEILING APPEARANCE	LAMP	CRI	COLOR TEMPERATURE	BEAM SPREAD**	FUNCTION	HOUSING RATING	DRIVER	VOLTAGE
<b>E2R</b> ELEMENT 2" ROUND	<b>L</b> FLANGELESS (CEILING MOUNT)††	<b>-LH</b> HIGH OUTPUT	<b>8</b> 80 CRI <b>9</b> 90 CRI	<b>27</b> 2700K <b>30</b> 3000K	<b>20</b> 20° <b>30</b> 30°	<b>A</b> ADJUSTABLE***	<b>I</b> IC AIRTIGHT <b>C</b> CHICAGO PLENUM	STANDARD ELV (LEAVE BLANK)	120 VOLT (LEAVE BLANK)
<b>E2S</b> ELEMENT 2" SQUARE	<b>F</b> FLANGED (CEILING MOUNT)††	<b>-LO</b> LOW OUTPUT	<b>35</b> 3500K <b>WD</b> WARM DIM*	<b>35</b> 3500K <b>WD</b> WARM DIM*	<b>40</b> 40° <b>60</b> 60°			<b>-010</b> 0-10V DIMMING LINEAR†	<b>-277</b> 277 VOLT
	<b>T</b> T-GRID/FLANGED (HOUSING MOUNT)							<b>-ELD0A</b> ELDOLED 0% 0-10V LOGARITHMIC†	
								<b>-ELD1</b> ELDOLED 1% 0-10V LINEAR†	
								<b>-ELD1A</b> ELDOLED 1% 0-10V LOGARITHMIC†	
								<b>-ELDD</b> ELDOLED 0% DALI†	
								<b>-HLECO</b> HI-LUME 1% ECO-SYSTEM FADE-TO-BLACK†	
								<b>-HL2W</b> HI-LUME 2 WIRE/PWM†‡	

A

TRIMS ARE REQUIRED AND MUST BE ORDERED SEPERATELY. \*WARM DIM 90 CRI ONLY. ONLY AVAILABLE LOW OUTPUT. \*\*30° OPTIMAL FOR WALL WASH USE. \*\*\*ADJUST TO 15° TILT FOR WALL WASH APPLICATION. †REMOTE MOUNT ONLY (REMOTE ENCLOSURE SUPPLIED BY OTHERS). ††120V INPUT ONLY. †††FOR MAX 2" CEILING THICKNESS, MECHANISM AND COLLAR ARE FIELD ASSEMBLED TO THE CEILING, FLUSH. ††††FOR MAX 1" CEILING THICKNESS, MECHANISM AND COLLAR ARE FACTORY ASSEMBLED TO THE HOUSING, TRIM EXTENDER COLLARS ARE REQUESTED FOR CEILING THICKNESSES GREATER THAN 0.500".

### TRIM

PRODUCT SERIES	CEILING APPEARANCE	STYLE	APERTURE	FINISH
<b>E2R</b> ELEMENT 2" ROUND	<b>L</b> FLANGELESS	<b>B</b> BEVEL	<b>-O</b> NO LENS	<b>Z</b> ANTIQUE BRONZE
<b>E2S</b> ELEMENT 2" SQUARE	<b>F</b> FLANGED**	<b>F</b> FLAT	<b>-H</b> SHOWER	<b>B</b> BLACK
	<b>F6</b> FLANGED TRIM EXTENDER, 0.500" - 0.625" CEILING THICKNESS***	<b>W</b> WALL WASH*	<b>-L</b> LENSED	<b>S</b> SATIN NICKEL
	<b>F7</b> FLANGED TRIM EXTENDER, 0.625" - 0.750" CEILING THICKNESS***		<b>-W</b> WALL WASH (LENSED)*	<b>W</b> WHITE
	<b>F8</b> FLANGED TRIM EXTENDER, 0.7500" - 0.875" CEILING THICKNESS***			
	<b>F1</b> FLANGED TRIM EXTENDER, 0.875" - 1.000" CEILING THICKNESS***			

\*WALL WASH STYLE TRIM (W) REQUIRES WALL WASH LENSED APERTURE (-W). \*\*IF USED WITH T-GRID/FLANGED (T) STYLE HOUSING, FLANGED TRIMS WORK FOR 0.500" CEILING THICKNESS WITHOUT TRIM EXTENDERS. \*\*\*FOR USE WITH T-GRID/FLANGED (T) STYLE HOUSING AND CEILING THICKNESS GREATER THAN 0.500".

### REPLACEMENT OPTICS

	BEAM SPREAD
<b>353LEDGATOPT</b>	<b>20</b> 20° <b>30</b> 30° <b>40</b> 40° <b>60</b> 60°

**353LEDGATOPT**

### LENSES/LOUVERS

	TYPE
<b>MOC</b>	<b>GG</b> PLAIN GLASS <b>SF</b> SOFT FOCUS <b>LL</b> LINEAR SPREAD <b>EC</b> EGGCRATE LOUVER <b>LS1</b> 1" LONG SNOOT <b>LS12</b> 1/2" LONG SNOOT

**MOC**

### APERTURE SHIELD FOR CEILING THICKER THAN 1"

PRODUCT SERIES	CEILING APPEARANCE	FINISH
<b>E2R</b> ELEMENT 2" ROUND	<b>AC</b> APERTURE COLLAR FOR UP TO 2" THICK CEILINGS	<b>B</b> BLACK
<b>E2S</b> ELEMENT 2" SQUARE		
	<b>AC</b>	<b>B</b>

## PROJECT INFO

FIXTURE TYPE & QUANTITY	JOB NAME & INFO	NOTES

**ELEMENT**  
by Tech Lighting®

GENERATION BRANDS  
7400 Linder Avenue, Skokie, Illinois 60077  
T 847.410.4400 F 847.410.4500



© 2017 Tech Lighting, L.L.C. All rights reserved. The "Tech Lighting" graphic is a registered trademark of Tech Lighting, L.L.C. Tech Lighting reserves the right to change specifications for product improvements without notification.

## PHOTOMETRICS: 2" CITIZEN LED

DESCRIPTION: 2" LED Module  
20° Beam - 0° Tilt, 3000K  
MODEL: E2 Adjustable 20° High Output

INPUT POWER (WATTS): 18.7  
INPUT POWER FACTOR: 0.98  
ABSOLUTE LUMINOUS FLUX (LUMENS): 1206  
LUMEN EFFICACY (LUMENS PER WATT): 64.5

ANGLE	0°	45°	90°
0°	5136	5136	5136
5°	4054	4347	4616
10°	2654	2956	3278
15°	1383	1756	1896
20°	627	878	924
25°	249	326	393
30°	81	128	151
35°	24	65	50
40°	6	30	12
45°	3	6	4
50°	1	2	2
55°	1	1	1
60°	0	1	0
65°	0	1	0
70°	0	1	0
75°	0	1	0
80°	0	0	0
85°	0	0	0
90°	0	0	0

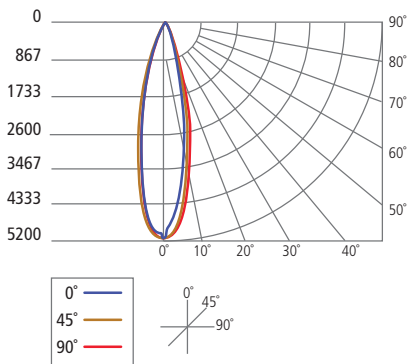
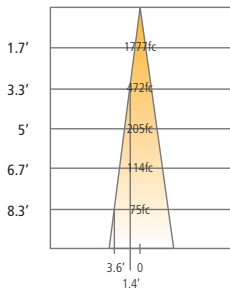

DESCRIPTION: 2" LED Module  
30° Beam - 0° Tilt, 3000K  
MODEL: E2 Adjustable 30° High Output

INPUT POWER (WATTS): 18.7  
INPUT POWER FACTOR: 0.98  
ABSOLUTE LUMINOUS FLUX (LUMENS): 1414  
LUMEN EFFICACY (LUMENS PER WATT): 75.5

ANGLE	0°	45°	90°
0°	4644	4644	4644
5°	4184	4322	4434
10°	3249	3454	3698
15°	1948	2286	2488
20°	933	1178	1304
25°	342	428	544
30°	87	161	176
35°	27	68	52
40°	7	27	12
45°	2	5	4
50°	1	2	1
55°	0	1	0
60°	0	1	0
65°	0	1	0
70°	0	0	0
75°	0	0	0
80°	0	0	0
85°	0	0	0
90°	0	0	0

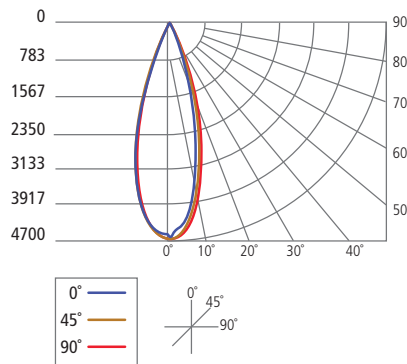
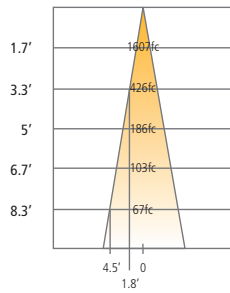

DESCRIPTION: 2" LED Module  
40° Beam - 0° Tilt, 3000K  
MODEL: E2 Adjustable 40° High Output

INPUT POWER (WATTS): 18.7  
INPUT POWER FACTOR: 0.98  
ABSOLUTE LUMINOUS FLUX (LUMENS): 1565  
LUMEN EFFICACY (LUMENS PER WATT): 83.7

ANGLE	0°	45°	90°
0°	3050	3050	3050
5°	2774	2892	2971
10°	2436	2549	2701
15°	1847	2085	2260
20°	1188	1460	1594
25°	571	776	959
30°	216	353	411
35°	84	142	154
40°	30	53	55
45°	11	18	20
50°	1	7	4
55°	0	2	0
60°	0	0	0
65°	0	0	0
70°	0	0	0
75°	0	0	0
80°	0	0	0
85°	0	0	0
90°	0	0	0

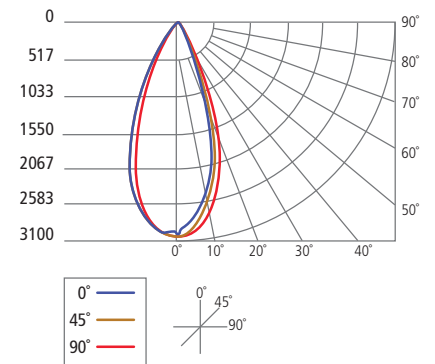
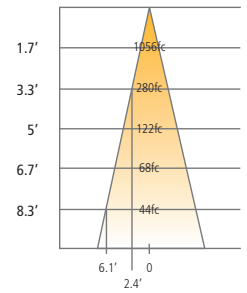

\*For 90 CRI values, multiply by 0.8.

## PHOTOMETRICS: 2" CITIZEN LED

DESCRIPTION: 2" LED Module  
60° Beam - 0° Tilt, 3000K

MODEL: E2 Adjustable 60° High Output

INPUT POWER (WATTS): 18.7

INPUT POWER FACTOR: 0.98

ABSOLUTE LUMINOUS FLUX (LUMENS): 1382

LUMEN EFFICACY (LUMENS PER WATT): 73.7

ANGLE	0°	45°	90°
0°	1764	1764	1764
5°	1667	1724	1721
10°	1562	1612	1629
15°	1380	1445	1483
20°	1109	1233	1235
25°	718	921	923
30°	442	638	542
35°	310	377	350
40°	208	239	238
45°	83	142	139
50°	1	70	26
55°	1	6	1
60°	0	1	0
65°	0	0	0
70°	0	1	0
75°	0	0	0
80°	0	0	0
85°	0	0	0
90°	0	0	0

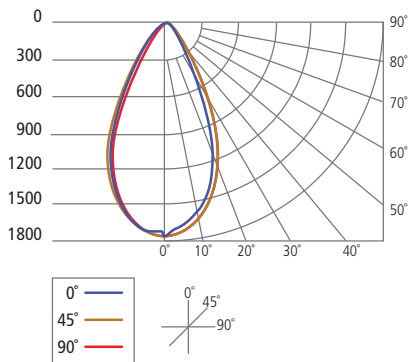
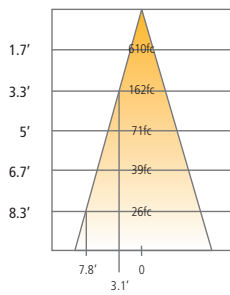

\*For 90 CRI values, multiply by 0.8.

GENERATION BRANDS



2017 Tech Lighting, L.L.C. All rights reserved. The "Element" graphic is a registered trademark of Element. Element reserves the right to change specifications for product improvements without notification.

**ELEMENT**  
by Tech Lighting®

7400 Linder Avenue, Skokie, Illinois 60077 T 847.410.4400 F 847.410.4500