

2" LED

REMODEL ADJUSTABLE DOWNLIGHT & WALL WASH

The ELEMENT 2" remodel adjustable downlight boasts a 1.4" aperture and 2.75" ceiling cutout. Newly developed aiming/locking mechanism offers 0-45° tilt, 361° rotation, and ELEMENT's patented high-low lamp positioning. Flanged or flangeless (includes mud plate), round or square, flat or beveled die-cast trims in four finishes with wet-listed options. Interchangeable optics: 20°, 30°, 40°, 60° and dedicated wall wash options. New construction also available. At this time not suitable for grid ceiling installation. Suitable for use in .375"-2" ceiling thickness (Note: tilt restriction in thicker ceilings.)

- Hot aiming/locking mechanism offers 0-45° tilt, 361° rotation, high-low lamp positioning
- Round or square, flat or beveled, flanged or flangeless cast trims in four finishes
- Interchangeable optics: 20°, 30°, 40°, 60° and wall wash trim options
- Mechanism and junction box serviced through ceiling aperture

SPECIFICATIONS

	HIGH OUTPUT (AT 3000K)		LOW OUTPUT (AT 3000K)		WARM DIM LOW OUTPUT
DELIVERED LUMENS	1565	1252	1163	930	850
WATTS	18.7	18.7	12.4	12.4	12
EFFICACY (L/W)	84	67	93	75	71
CRI	80+	90+	80+	90+	90+
CBCP	20° - 5136; 30° - 4644; 40° - 3050; 60° - 1764				
CCT OPTIONS	2700K, 3000K, 3500K, Warm Color Dimming (3000K-1800K)				
VOLTAGE	120V or 277V				
DIMMING*	TRIAC, ELV or 0-10V				
POWER SUPPLY	Constant Current driver with +.9 power factor and +80% efficiency				
OPTICS	20°, 30°, 40°, 60°				
ADJUSTABILITY	0-45° tilt, 361° rotation, high-low lamp positioning				
CEILING APPEARANCE	Flanged or Flangeless (Both accommodate 3/8" to 2" ceiling thickness. Note: tilt restriction in thicker ceilings.)				
CEILING APERTURE	2.75" ceiling cutout				
HOUSING	Non-IC				
CONSTRUCTION	Housing: Heavy gauge cold rolled steel Trims: Die-cast aluminum				
FINISH	Housing: Black powder coat Trims: Antique Bronze, Black, Satin Nickel, White (paintable)				
GENERAL LISTING	ETL listed. Damp listed. Shower version wet listed.				
LED LIFETIME	L70; 50,000 hours				
WARRANTY**	5 Years				



2" remodel adjustable

*See ELEMENT-lighting.com for dimmer compatibility.
**Visit ELEMENT-lighting.com for specific warranty limitations and details.

TRIMS

ROUND

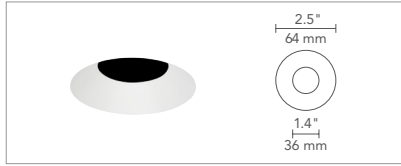

FLANGELESS BEVEL

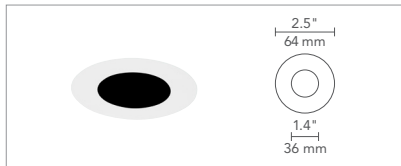

FLANGELESS FLAT

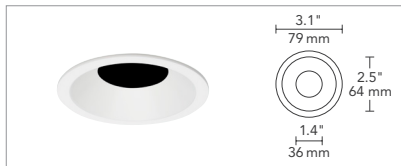

FLANGED BEVEL

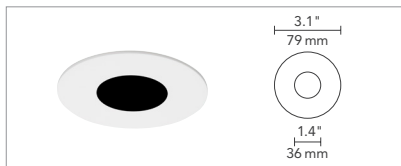

FLANGED FLAT

SQUARE

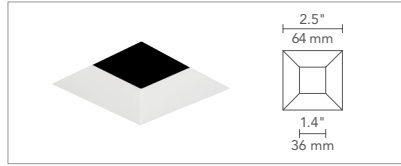

FLANGELESS BEVEL

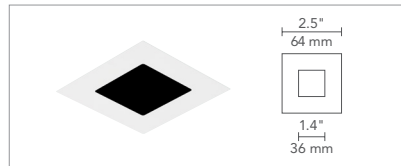

FLANGELESS FLAT

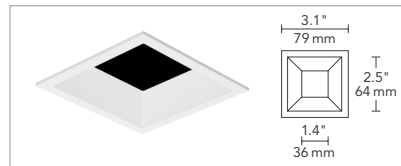

FLANGED BEVEL

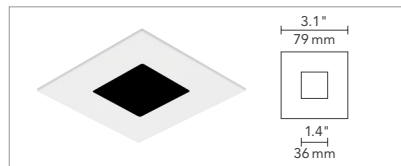

FLANGED FLAT

WALL WASH

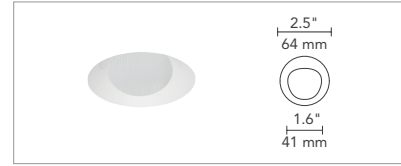

FLANGELESS WALL WASH



FLANGED WALL WASH

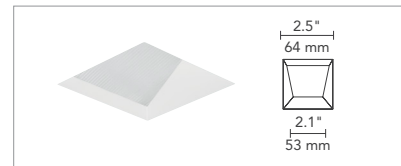

FLANGELESS WALL WASH



FLANGED WALL WASH

FINISH



ANTIQUE BRONZE



BLACK



SATIN NICKEL



WHITE (PAINTABLE)

2" MECHANISM*

ROUND

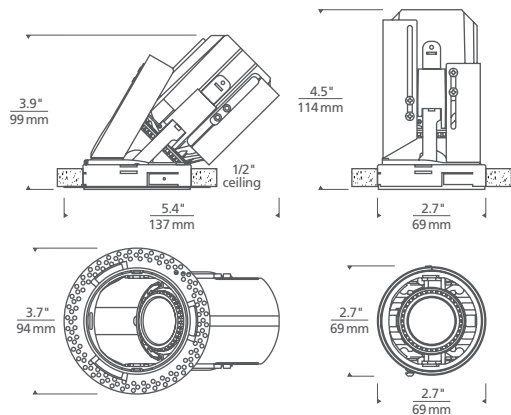

*SHOWN IN ROUND FLANGELESS AT FULL TILT (45°)

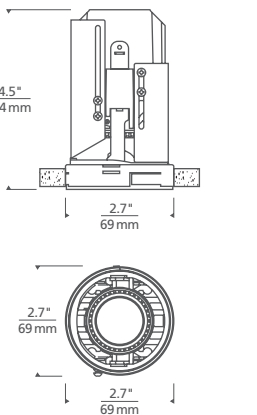

*SHOWN IN ROUND FLANGED AT NO TILT (0°)

SQUARE

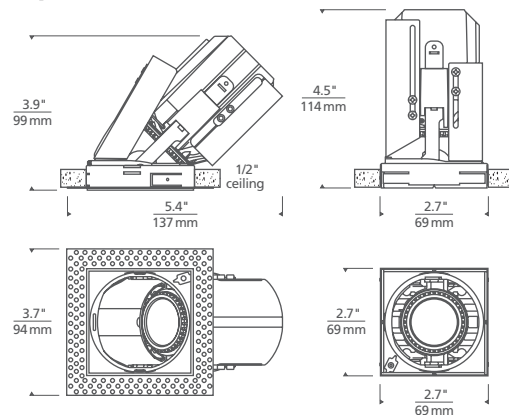

*SHOWN IN SQUARE FLANGELESS AT FULL TILT (45°)

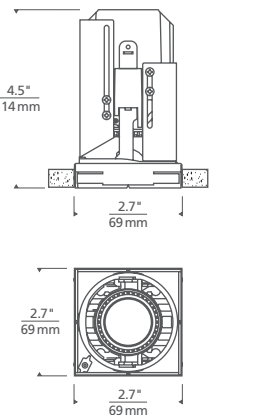

*SHOWN IN SQUARE FLANGED AT NO TILT (0°)

DRIVERS

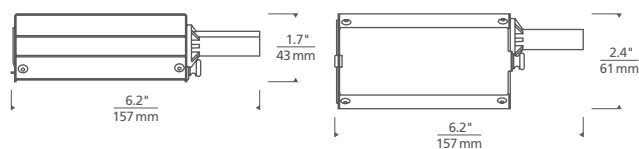

DRIVERS

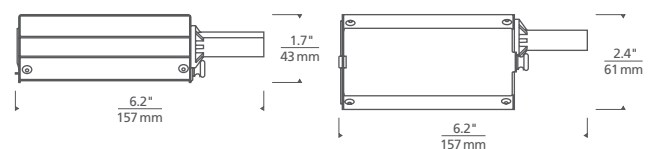

2" LED

REMODEL ADJUSTABLE DOWNLIGHT & WALL WASH

GRIDS

HOUSING

PRODUCT SERIES	CEILING APPEARANCE	LAMP	CRI	COLOR TEMPERATURE	BEAM SPREAD**	FUNCTION	HOUSING RATING	DRIVER	VOLTAGE
E2R ELEMENT 2" ROUND	RL REMODEL FLANGELESS	-LH HIGH OUTPUT	8 80 CRI 9 90 CRI	27 2700K 30 3000K	20 20° 30 30°	A ADJUSTABLE***	N NON-IC	STANDARD ELV (LEAVE BLANK)	120 VOLT (LEAVE BLANK)
E2S ELEMENT 2" SQUARE	RF REMODEL FLANGED	-LO LOW OUTPUT	35 3500K WD WARM DIM*	40 40° 60 60°	40 40° 60 60°			-010 0-10V DIMMING	-277 277 VOLT
							A	N	

TRIMS ARE REQUIRED AND MUST BE ORDERED SEPARATELY.
 AT THIS TIME NOT AVAILABLE FOR GRID CEILING INSTALLATION.
 *WARM DIM 90 CRI ONLY. ONLY AVAILABLE LOW OUTPUT.
 **30° OPTIMAL FOR WALL WASH USE.
 ***ADJUST TO 15° TILT FOR WALL WASH APPLICATION.

TRIM

PRODUCT SERIES	CEILING APPEARANCE	STYLE	APERTURE	FINISH
E2R ELEMENT 2" ROUND	L FLANGELESS	B BEVEL	-O NO LENS	Z ANTIQUE BRONZE
E2S ELEMENT 2" SQUARE	F FLANGED	F FLAT	-H SHOWER	B BLACK
		W WALL WASH*	-L LENSED	S SATIN NICKEL
			-W WALL WASH (LENSED)*	W WHITE

*WALL WASH STYLE TRIM (W) REQUIRES WALL WASH LENSED APERTURE (-W).

REPLACEMENT OPTICS

	BEAM SPREAD
353LEDGATOPT	20 20° 30 30° 40 40° 60 60°

353LEDGATOPT

LENSES/LOUVERS

MOC	TYPE
GG	PLAIN GLASS
SF	SOFT FOCUS
LL	LINEAR SPREAD
EC	EGGCRATE LOUVER
LS1	1" LONG SNOOT
LS12	1/2" LONG SNOOT

MOC

APERTURE SHIELD FOR CEILING THICKER THAN 1"

PRODUCT SERIES	CEILING APPEARANCE	FINISH
E2R ELEMENT 2" ROUND	AC APERTURE COLLAR FOR UP TO 2" THICK CEILINGS	B BLACK
E2S ELEMENT 2" SQUARE		
AC		B

PROJECT INFO

FIXTURE TYPE & QUANTITY

JOB NAME & INFO

NOTES

ELEMENT
by Tech Lighting®

GENERATION BRANDS
 7400 Linder Avenue, Skokie, Illinois 60077
 T 847.410.4400 F 847.410.4500



© 2017 Tech Lighting, L.L.C. All rights reserved. The "Tech Lighting" graphic is a registered trademark of Tech Lighting, L.L.C. Tech Lighting reserves the right to change specifications for product improvements without notification.

2" LED

REMODEL ADJUSTABLE DOWNLIGHT & WALL WASH

PHOTOMETRICS: 2" CITIZEN LED

DESCRIPTION: 2" LED Module
20° Beam - 0° Tilt, 3000K
MODEL: E2 Adjustable 20° High Output

INPUT POWER (WATTS): 18.7
INPUT POWER FACTOR: 0.98
ABSOLUTE LUMINOUS FLUX (LUMENS): 1206
LUMEN EFFICACY (LUMENS PER WATT): 64.5

ANGLE	0°	45°	90°
0°	5136	5136	5136
5°	4054	4347	4616
10°	2654	2956	3278
15°	1383	1756	1896
20°	627	878	924
25°	249	326	393
30°	81	128	151
35°	24	65	50
40°	6	30	12
45°	3	6	4
50°	1	2	2
55°	1	1	1
60°	0	1	0
65°	0	1	0
70°	0	1	0
75°	0	1	0
80°	0	0	0
85°	0	0	0
90°	0	0	0

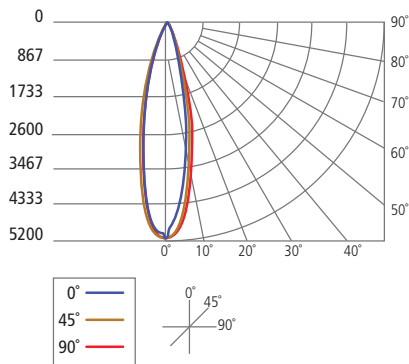
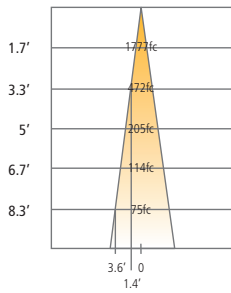

DESCRIPTION: 2" LED Module
30° Beam - 0° Tilt, 3000K
MODEL: E2 Adjustable 30° High Output

INPUT POWER (WATTS): 18.7
INPUT POWER FACTOR: 0.98
ABSOLUTE LUMINOUS FLUX (LUMENS): 1414
LUMEN EFFICACY (LUMENS PER WATT): 75.5

ANGLE	0°	45°	90°
0°	4644	4644	4644
5°	4184	4322	4434
10°	3249	3454	3698
15°	1948	2286	2488
20°	933	1178	1304
25°	342	428	544
30°	87	161	176
35°	27	68	52
40°	7	27	12
45°	2	5	4
50°	1	2	1
55°	0	1	0
60°	0	1	0
65°	0	1	0
70°	0	0	0
75°	0	0	0
80°	0	0	0
85°	0	0	0
90°	0	0	0

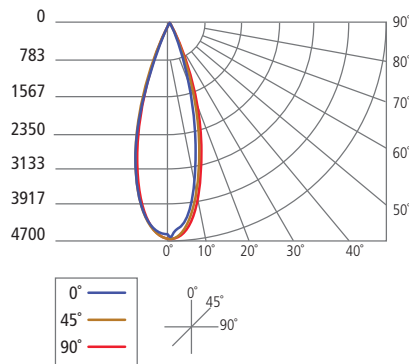
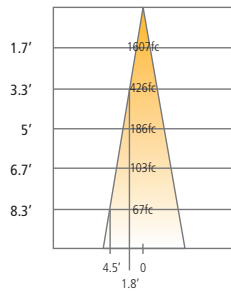

DESCRIPTION: 2" LED Module
40° Beam - 0° Tilt, 3000K
MODEL: E2 Adjustable 40° High Output

INPUT POWER (WATTS): 18.7
INPUT POWER FACTOR: 0.98
ABSOLUTE LUMINOUS FLUX (LUMENS): 1565
LUMEN EFFICACY (LUMENS PER WATT): 83.7

ANGLE	0°	45°	90°
0°	3050	3050	3050
5°	2774	2892	2971
10°	2436	2549	2701
15°	1847	2085	2260
20°	1188	1460	1594
25°	571	776	959
30°	216	353	411
35°	84	142	154
40°	30	53	55
45°	11	18	20
50°	1	7	4
55°	0	2	0
60°	0	0	0
65°	0	0	0
70°	0	0	0
75°	0	0	0
80°	0	0	0
85°	0	0	0
90°	0	0	0

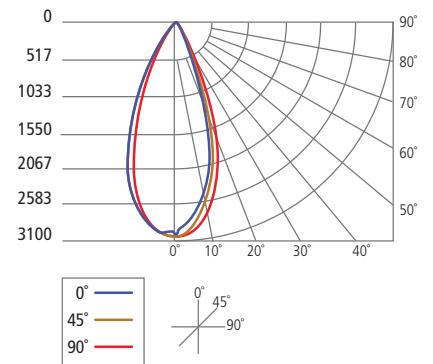
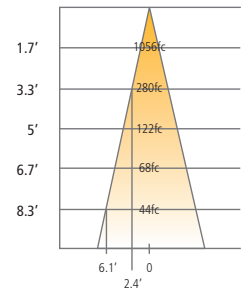

*For 90 CRI values, multiply by 0.8.

2" LED

REMODEL ADJUSTABLE DOWNLIGHT & WALL WASH

PHOTOMETRICS: 2" CITIZEN LED

DESCRIPTION: 2" LED Module
60° Beam - 0° Tilt, 3000K

MODEL: E2 Adjustable 60° High Output

INPUT POWER (WATTS): 18.7

INPUT POWER FACTOR: 0.98

ABSOLUTE LUMINOUS FLUX (LUMENS): 1382

LUMEN EFFICACY (LUMENS PER WATT): 73.7

ANGLE	0°	45°	90°
0°	1764	1764	1764
5°	1667	1724	1721
10°	1562	1612	1629
15°	1380	1445	1483
20°	1109	1233	1235
25°	718	921	923
30°	442	638	542
35°	310	377	350
40°	208	239	238
45°	83	142	139
50°	1	70	26
55°	1	6	1
60°	0	1	0
65°	0	0	0
70°	0	1	0
75°	0	0	0
80°	0	0	0
85°	0	0	0
90°	0	0	0

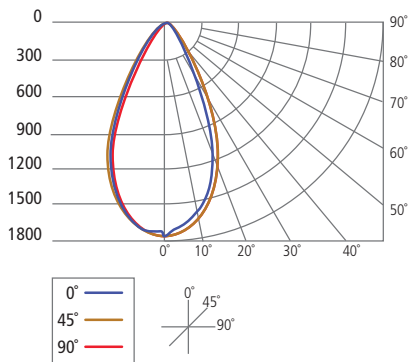
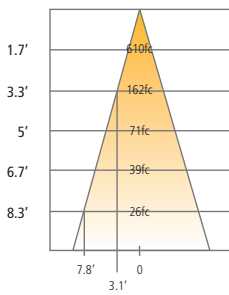

*For 90 CRI values, multiply by 0.8.

GENERATION BRANDS



2017 Tech Lighting, L.L.C. All rights reserved. The "Element" graphic is a registered trademark of Element. Element reserves the right to change specifications for product improvements without notification.

ELEMENT
by Tech Lighting®

7400 Linder Avenue, Skokie, Illinois 60077 T 847.410.4400 F 847.410.4500