

Project Name:	Type:
Part Number:	Date:

4" INNOFIT GEN 2 COMMERCIAL DOWNLIGHT

SPECIFICATION FEATURES

- **Mechanical** - INNOFIT, with integrated driver, retrofits existing commercial housings and is field accessible from below the ceiling. Stainless steel spring action clips accommodate ½" to 2" ceiling thicknesses. Optional New Construction housing available.
- **Electrical** - Field select from three lumen outputs using SelectDrive technology. Universal 120-277V or 120V only, 50/60 Hz drivers available. Universal 0-10V drivers are dimmable to 5% with low end cutoff. 120V drivers are dimmable to 10% using forward or reverse phase dimmers.
- **Optical** - Self flanged, spun aluminum reflector with baffle trim for pleasant aesthetic in matte white finish. High resistance polycarbonate optical lens, with smooth diffusion. 90° beam angle. LED binned to 3-step SDCM to ensure color uniformity in 2700K, 3000K, 3500K, 4000K or 5000K CCT, with Minimum 80 CRI.
- **Thermal** - Fixture designed using passive thermal management to achieve a L70 rating of 50,000 hours.
Fixture operating temperature: -13°F to 95°F (-25°C to 35°C).
- **Compliance and Warranty** - ETL Classified and Listed for wet locations. Certified air-tight per ASTM 283-04. IC Rated for direct contact with insulation. Complies with FCC 47CFR Part 15B consumer limits for EMI/RFI emissions. 5 year parts warranty for complete fixture. Optional 10 Year Extended Warranty available, subject to same terms, conditions and installation requirements as standard 5 Year Warranty.



040921



BENEFITS

- Field select lumen output
- Quick and easy installation
- 0-10V or 120V dimmable
- Wet Location, IC and Airtight Rated
- Long life time, L70 Rated for 50,000 hours

APPLICATIONS

- New and retrofit construction
- Shallow plenum applications
- Commercial
- Retail & Office
- Education and Hospitality

ORDERING INFORMATION

Series	Size	CRI	CCT	Dimming
<input checked="" type="checkbox"/> INFT INNOFIT	<input checked="" type="checkbox"/> 4 4" 500 / 700 / 1,000 lumens	<input checked="" type="checkbox"/> 8 CRI 80	<input type="checkbox"/> 27 2700K	<input type="checkbox"/> DIM010UNV 120-277V, 0-10V (Dimmable to 5%)
			<input type="checkbox"/> 30 3000K	
			<input type="checkbox"/> 35 3500K	
			<input type="checkbox"/> 40 4000K	
			<input type="checkbox"/> 50 5000K	



4" INNOFIT GEN 2 COMMERCIAL DOWNLIGHT

LINE DRAWINGS

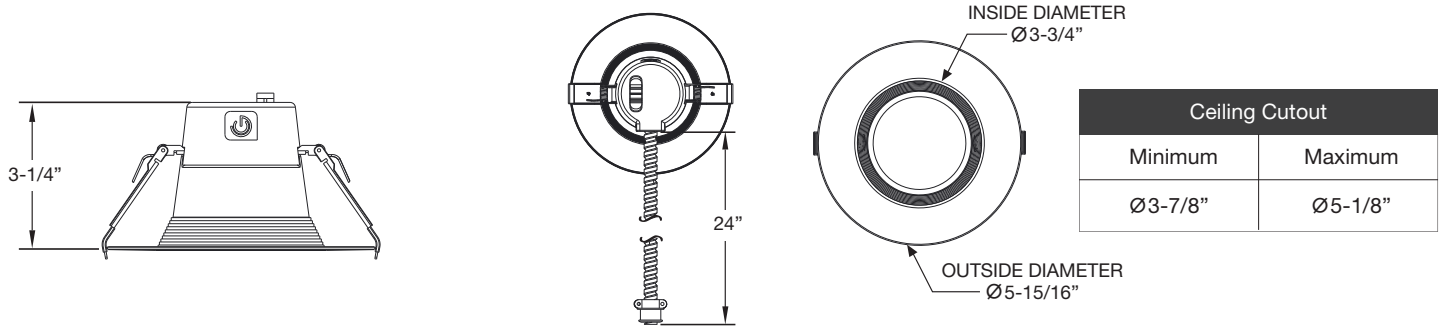

Ceiling Cutout	
Minimum	Maximum
Ø3-7/8"	Ø5-1/8"

TECHNICAL INFORMATION

Dimming	Input Voltage	Input Frequency	Input Current (Low / Med / High)	Input Power	THD Power	Power Factor
DIM120V	120V	50 / 60Hz	0.045 / 0.06 / 0.085A	5 / 7 / 10W	<20%	>0.9
DIM010VUNV	120V	50 / 60Hz	0.045 / 0.06 / 0.085A	5 / 7 / 10W	<20%	>0.9
	277V					

PHOTOMETRY

INFT4/835/DIM010UNV (HIGH OUTPUT)

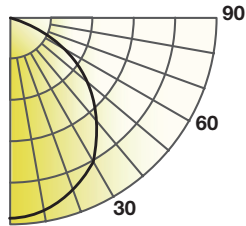

Lumens: 1,149 lm
CBCP: 518 cd
Power: 10.2 W
Efficacy: 112 lm/W
CRI: 80+
Spacing Criteria: 1.18
Beam Angle: 94.6°

Candlepower Distribution	
Angle (°)	Average (cd)
0	515
5	514
15	491
25	444
35	374
45	288
55	196
65	109
75	38
85	6
90	0

Initial Footcandles		
Height (ft)	Fc	Diameter (ft)
8	12	17.3
9	9	19.5
10	8	21.7
12	5	26.0
15	3	32.5











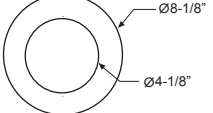

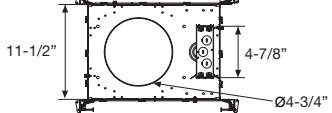
Zonal Lumen Summary		
Zone	Lumens	%Fixture
0-30	388	34%
0-40	618	54%
0-60	1,001	87%
0-90	1,149	100%

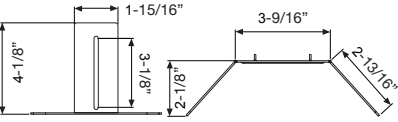
NOMINAL PERFORMANCE

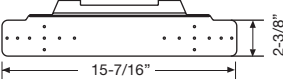
CCT	2700K			3000K			3500K			4000K			5000K		
	Low	Med	High	Low	Med	High	Low	Med	High	Low	Med	High	Low	Med	High
Lumens	510	715	1,020	525	735	1,050	535	750	1,070	545	765	1,090	545	765	1,090
LPW	102	102	102	105	105	105	107	107	107	109	109	109	109	109	109

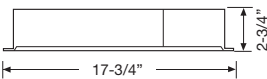

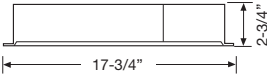
4" INNOFIT GEN 2 COMMERCIAL DOWNLIGHT

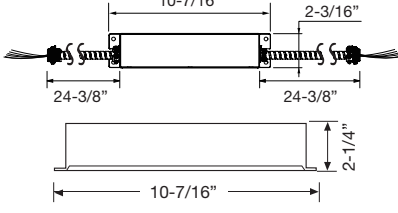
ACCESSORY ORDERING INFORMATION				
Product	Model	Description	Pictures	Dimensions
98569	GOOFRING4	4" Goof Ring - Outer Diameter 8-1/8"		
35121	NCFJB4	4" Round New Construction Rough-in Frame with Jbox		
35126	NCFBFB	Field Installable Butterfly Brackets For New Construction Rough-in Frame		
35125	NCFEMB	Field Installable Emergency Bracket For New Construction Rough-in Frame		
58012	35EMINVERTER	35W Emergency Inverter (Field Installation)		
58013	35EMINVERTER/CEC	California Title 20 Compliant 35W Emergency Inverter (Field Installation)		
98003	23EMDRIVER	California Title 20 Compliant 23W Emergency LED Driver (Field Installation)		



4" INNOFIT GEN 2 COMMERCIAL DOWNLIGHT

ORDERING GUIDE

Product	Model
35061	INFT4/827/DIM010UNV
35062	INFT4/830/DIM010UNV
35063	INFT4/835/DIM010UNV
35064	INFT4/840/DIM010UNV
35065	INFT4/850/DIM010UNV
35101	INFT4/827/DIM120V
35102	INFT4/830/DIM120V
35103	INFT4/835/DIM120V
35104	INFT4/840/DIM120V
35105	INFT4/850/DIM120V

10 YEAR EXTENDED WARRANTY

Model	INFT4/10YEARWARRANTY
-------	----------------------

Note: All rights reserved. All sizes and specifications are subject to change at any time without notice.

Project Name:	Type:
Part Number:	Date:

6" INNOFIT GEN 2 COMMERCIAL DOWNLIGHT

SPECIFICATION FEATURES

- **Mechanical** - INNOFIT, with integrated driver, retrofits existing commercial housings and is field accessible from below the ceiling. Stainless steel spring action clips accommodate ½" to 2" ceiling thicknesses. Optional New Construction housing available.
- **Electrical** - Field select from three lumen outputs using SelectDrive technology. Universal 120-277V or 120V only, 50/60 Hz drivers available. Universal 0-10V drivers are dimmable to 5% with low end cutoff. 120V drivers are dimmable to 10% using forward or reverse phase dimmers.
- **Optical** - Self flanged, spun aluminum reflector with baffle trim for pleasant aesthetic in matte white finish. High resistance polycarbonate optical lens, with smooth diffusion. 105° beam angle. LED binned to 3-step SDCM to ensure color uniformity in 2700K, 3000K, 3500K, 4000K or 5000K CCT, with Minimum 80 CRI.
- **Thermal** - Fixture designed using passive thermal management to achieve a L70 rating of 50,000 hours.
Fixture operating temperature: -13°F to 95°F (-25°C to 35°C).
- **Compliance and Warranty** - ETL Classified and Listed for wet locations. Certified air-tight per ASTM 283-04. IC Rated for direct contact with insulation. Complies with FCC 47CFR Part 15B consumer limits for EMI/RFI emissions. 5 year parts warranty for complete fixture. Optional 10 Year Extended Warranty available, subject to same terms, conditions and installation requirements as standard 5 Year Warranty.



040921



BENEFITS

- Field select lumen output
- Quick and easy installation
- 0-10V or 120V dimmable
- Wet Location, IC and Airtight Rated
- Long life time, L70 Rated for 50,000 hours

APPLICATIONS

- New and retrofit construction
- Shallow plenum applications
- Commercial
- Retail & Office
- Education and Hospitality

ORDERING INFORMATION

Series	Size	CRI	CCT	Dimming
<input checked="" type="checkbox"/> INFT INNOFIT	<input checked="" type="checkbox"/> 6 6" 800 / 1,100 / 1,600 lumens	<input checked="" type="checkbox"/> 8 CRI 80	<input type="checkbox"/> 27 2700K	<input type="checkbox"/> DIM010UNV 120-277V, 0-10V (Dimmable to 5%)
			<input type="checkbox"/> 30 3000K	
			<input type="checkbox"/> 35 3500K	
			<input type="checkbox"/> 40 4000K	
			<input type="checkbox"/> 50 5000K	

6" INNOFIT GEN 2 COMMERCIAL DOWNLIGHT

LINE DRAWINGS

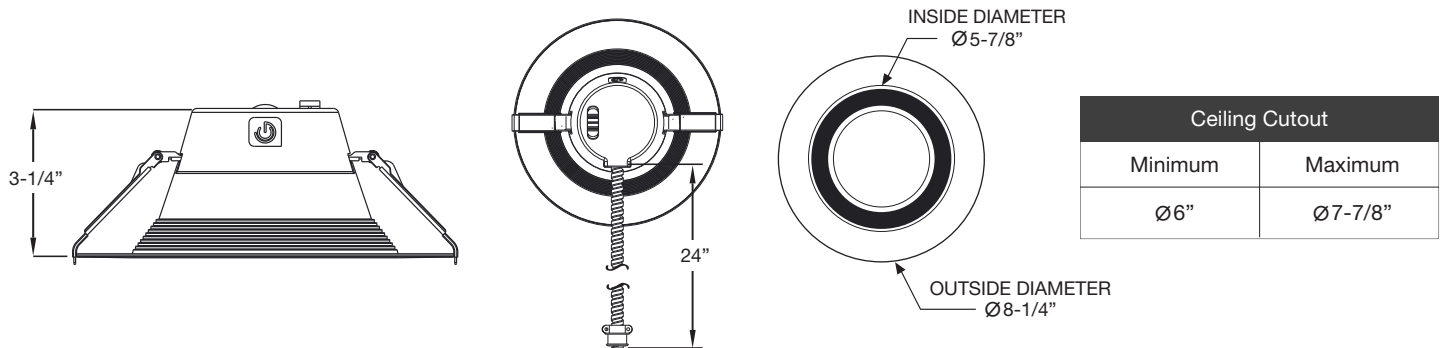

TECHNICAL INFORMATION

Dimming	Input Voltage	Input Frequency	Input Current (Low / Med / High)	Input Power	THD Power	Power Factor
DIM120V	120V	50 / 60Hz	0.06 / 0.08 / 0.11A	6.5 / 9 / 13W	<20%	>0.9
DIM010VUNV	120V	50 / 60Hz	0.055 / 0.08 / 0.11A	6.5 / 9 / 13W	<20%	>0.9
	277V		0.032 / 0.04 / 0.052A			

PHOTOMETRY

INFT6/835/DIM010UNV (HIGH OUTPUT)

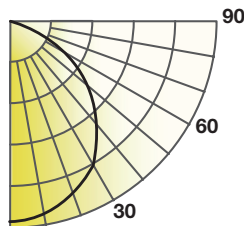

Lumens: 1,686 lm
 CBCP: 673 cd
 Power: 12.4 W
 Efficacy: 136 lm/W
 CRI: 80+
 Spacing Criteria: 1.24
 Beam Angle: 104.4°

Candlepower Distribution	
Angle (°)	Average (cd)
0	673
5	671
15	643
25	590
35	514
45	423
55	309
65	189
75	72
85	7
90	0

Initial Footcandles		
Height (ft)	Fc	Diameter (ft)
8	16	20.6
9	12	23.2
10	10	25.8
12	7	30.9
15	4	38.7

Zonal Lumen Summary		
Zone	Lumens	%Fixture
0-30	514	30%
0-40	833	49%
0-60	1,425	85%
0-90	1,686	100%

PERFORMANCE

CCT	2700K			3000K			3500K			4000K			5000K		
	Low	Med	High	Low	Med	High	Low	Med	High	Low	Med	High	Low	Med	High
Lumens	745	1,035	1,495	765	1,060	1,535	780	1,080	1,560	800	1,105	1,600	800	1,105	1,600
LPW	115	115	115	118	118	118	120	120	120	123	123	123	123	123	123



6" INNOFIT GEN 2 COMMERCIAL DOWNLIGHT

ACCESSORY ORDERING INFORMATION				
Product	Model	Description	Pictures	Dimensions
98568	GOOFRING6	Goof ring for extending from 8-1/4" to 10-1/2"		
35122	NCFJB6	6" Round New Construction Rough-in Frame with Jbox		
35126	NCFBFB	Field Installable Butterfly Brackets For New Construction Rough-in Frame		
35125	NCFEMB	Field Installable Emergency Bracket For New Construction Rough-in Frame		
58012	35EMINVERTER	35W Emergency Inverter (Field Installation)		
58013	35EMINVERTER/CEC	California Title 20 Compliant 35W Emergency Inverter (Field Installation)		
98003	23EMDRIVER	California Title 20 Compliant 23W Emergency LED Driver (Field Installation)		



6" INNOFIT GEN 2 COMMERCIAL DOWNLIGHT

ORDERING GUIDE

Product	Model
35066	INFT6/827/DIM010UNV
35067	INFT6/830/DIM010UNV
35068	INFT6/835/DIM010UNV
35069	INFT6/840/DIM010UNV
35070	INFT6/850/DIM010UNV
35106	INFT6/827/DIM120V
35107	INFT6/830/DIM120V
35108	INFT6/835/DIM120V
35109	INFT6/840/DIM120V
35110	INFT6/850/DIM120V

10 YEAR EXTENDED WARRANTY

Model	INFT6/10YEARWARRANTY
-------	----------------------

Note: All rights reserved. All sizes and specifications are subject to change at any time without notice.

Project Name:	Type:
Part Number:	Date:

8" INNOFIT GEN 2 COMMERCIAL DOWNLIGHT

SPECIFICATION FEATURES

- **Mechanical** - INNOFIT, with integrated driver, retrofits existing commercial housings and is field accessible from below the ceiling. Stainless steel spring action clips accommodate ½" to 2" ceiling thicknesses. Optional New Construction housing available.
- **Electrical** - Field select from three lumen outputs using SelectDrive technology. Universal 120-277V or 120V only, 50/60 Hz drivers available. Universal 0-10V drivers are dimmable to 5% with low end cutoff. 120V drivers are dimmable to 10% using forward or reverse phase dimmers.
- **Optical** - Self flanged, spun aluminum reflector with baffle trim for pleasant aesthetic in matte white finish. High resistance polycarbonate optical lens, with smooth diffusion. 110° beam angle. LED binned to 3-step SDCM to ensure color uniformity in 2700K, 3000K, 3500K, 4000K or 5000K CCT, with Minimum 80 CRI.
- **Thermal** - Fixture designed using passive thermal management to achieve a L70 rating of 50,000 hours.
Fixture operating temperature: -13°F to 95°F (-25°C to 35°C).
- **Compliance and Warranty** - ETL Classified and Listed for wet locations. Certified air-tight per ASTM 283-04. IC Rated for direct contact with insulation. Complies with FCC 47CFR Part 15B consumer limits for EMI/RFI emissions. 5 year parts warranty for complete fixture. Optional 10 Year Extended Warranty available, subject to same terms, conditions and installation requirements as standard 5 Year Warranty.



040921



BENEFITS

- Field select lumen output
- Quick and easy installation
- 0-10V or 120V dimmable
- Wet Location, IC and Airtight Rated
- Long life time, L70 Rated for 50,000 hours

APPLICATIONS

- New and retrofit construction
- Shallow plenum applications
- Commercial
- Retail & Office
- Education and Hospitality

ORDERING INFORMATION

Series	Size	CRI	CCT	Dimming
<input checked="" type="checkbox"/> INFT INNOFIT	<input checked="" type="checkbox"/> 8 8" 1,100 / 1,600 / 2,100 lumens	<input checked="" type="checkbox"/> 8 CRI 80	<input type="checkbox"/> 27 2700K	<input type="checkbox"/> DIM010UNV 120-277V, 0-10V (Dimmable to 5%)
			<input type="checkbox"/> 30 3000K	
			<input type="checkbox"/> 35 3500K	
			<input type="checkbox"/> 40 4000K	
			<input type="checkbox"/> 50 5000K	



8" INNOFIT GEN 2 COMMERCIAL DOWNLIGHT

LINE DRAWINGS

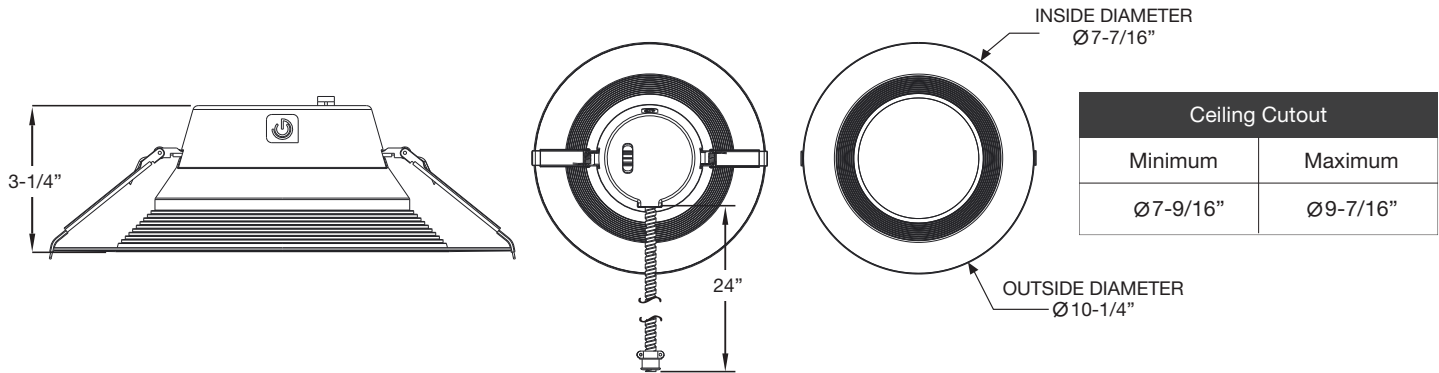

TECHNICAL INFORMATION

Dimming	Input Voltage	Input Frequency	Input Current (Low / Med / High)	Input Power	THD Power	Power Factor
DIM120V	120V	50 / 60Hz	0.078 / 0.1 / 0.145A	8.5 / 12 / 17W	<20%	>0.9
DIM010VUNV	120V	50 / 60Hz	0.07 / 0.1 / 0.145A	8.5 / 12 / 17W	<20%	>0.9
	277V		0.045 / 0.06 / 0.078A			

PHOTOMETRY

INFT8/835/DIM010UNV (HIGH OUTPUT)

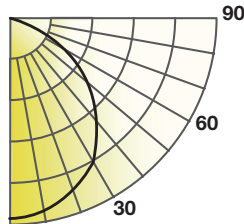

Lumens: 2,296 lm
CBCP: 898 cd
Power: 17.6 W
Efficacy: 130 lm/W
CRI: 80+
Spacing Criteria: 1.22
Beam Angle: 106.5°

Candlepower Distribution	
Angle (°)	Average (cd)
0	989
5	893
15	851
25	788
35	689
45	571
55	434
65	270
75	109
85	7
90	0

Initial Footcandles		
Height (ft)	Fc	Diameter (ft)
8	23	21.4
9	18	24.1
10	15	26.8
12	10	32.1
15	7	40.2

Zonal Lumen Summary		
Zone	Lumens	%Fixture
0-30	686	30%
0-40	1,112	48%
0-60	1,922	84%
0-90	2,296	100%

PERFORMANCE

CCT	2700K			3000K			3500K			4000K			5000K		
	Low	Med	High	Low	Med	High	Low	Med	High	Low	Med	High	Low	Med	High
Output	1,000	1,415	2,000	1,030	1,450	2,060	1,045	1,475	2,090	1,060	1,500	2,125	1,060	1,500	2,125
LPW	118	118	118	121	121	121	123	123	123	125	125	125	125	125	125



8" INNOFIT GEN 2 COMMERCIAL DOWNLIGHT

ACCESSORY ORDERING INFORMATION				
Product	Model	Description	Pictures	Dimensions
98567	GOOFRING8	8" Goof Ring - Outer Diameter 12-1/2"		
35123	NCFJB8	8" Round New Construction Rough-in Frame with Jbox		
35126	NCFBFB	Field Installable Butterfly Brackets For New Construction Rough-in Frame		
35125	NCFEMB	Field Installable Emergency Bracket For New Construction Rough-in Frame		
58012	35EMINVERTER	35W Emergency Inverter (Field Installation)		
58013	35EMINVERTER/CEC	California Title 20 Compliant 35W Emergency Inverter (Field Installation)		
98003	23EMDRIVER	California Title 20 Compliant 23W Emergency LED Driver (Field Installation)		



8" INNOFIT GEN 2 COMMERCIAL DOWNLIGHT

ORDERING GUIDE

Product	Model
35071	INFT8/827/DIM010UNV
35072	INFT8/830/DIM010UNV
35073	INFT8/835/DIM010UNV
35074	INFT8/840/DIM010UNV
35075	INFT8/850/DIM010UNV
35111	INFT8/827/DIM120V
35112	INFT8/830/DIM120V
35113	INFT8/835/DIM120V
35114	INFT8/840/DIM120V
35115	INFT8/850/DIM120V

10 YEAR EXTENDED WARRANTY

Model	INFT8/10YEARWARRANTY
-------	----------------------

Note: All rights reserved. All sizes and specifications are subject to change at any time without notice.

Project Name:	Type:
Part Number:	Date:

9.5" INNOFIT GEN 2 COMMERCIAL DOWNLIGHT

SPECIFICATION FEATURES

- **Mechanical** - INNOFIT, with integrated driver, retrofits existing commercial housings and is field accessible from below the ceiling. Stainless steel spring action clips accommodate ½" to 2" ceiling thicknesses. Optional New Construction housing available.
- **Electrical** - Field select from three lumen outputs using SelectDrive technology. Universal 120-277V or 120V only, 50/60 Hz drivers available. Universal 0-10V drivers are dimmable to 5% with low end cutoff. 120V drivers are dimmable to 10% using forward or reverse phase dimmers.
- **Optical** - Self flanged, spun aluminum reflector with baffle trim for pleasant aesthetic in matte white finish. High resistance polycarbonate optical lens, with smooth diffusion. 110° beam angle. LED binned to 3-step SDCM to ensure color uniformity in 2700K, 3000K, 3500K, 4000K or 5000K CCT, with Minimum 80 CRI.
- **Thermal** - Fixture designed using passive thermal management to achieve a L70 rating of 50,000 hours. Fixture operating temperature: -13°F to 95°F (-25°C to 35°C).
- **Compliance and Warranty** - ETL Classified and Listed for wet locations. Certified air-tight per ASTM 283-04. IC Rated for direct contact with insulation. Complies with FCC 47CFR Part 15B consumer limits for EMI/RFI emissions. 5 year parts warranty for complete fixture. Optional 10 Year Extended Warranty available, subject to same terms, conditions and installation requirements as standard 5 Year Warranty.



040921



BENEFITS

- Field select lumen output
- Quick and easy installation
- 0-10V or 120V dimmable
- Wet Location, IC and Airtight Rated
- Long life time, L70 Rated for 50,000 hours

APPLICATIONS

- New and retrofit construction
- Shallow plenum applications
- Commercial
- Retail & Office
- Education and Hospitality

ORDERING INFORMATION

Series	Size	CRI	CCT	Dimming
<input checked="" type="checkbox"/> INFT INNOFIT	<input checked="" type="checkbox"/> 9.5 9.5" 2,100 / 2,600 / 3,500 lumens	<input checked="" type="checkbox"/> 8 CRI 80	<input type="checkbox"/> 27 2700K	<input type="checkbox"/> DIM010UNV 120-277V, 0-10V (Dimmable to 5%)
			<input type="checkbox"/> 30 3000K	
			<input type="checkbox"/> 35 3500K	
			<input type="checkbox"/> 40 4000K	
			<input type="checkbox"/> 50 5000K	



9.5" INNOFIT GEN 2 COMMERCIAL DOWNLIGHT

LINE DRAWINGS

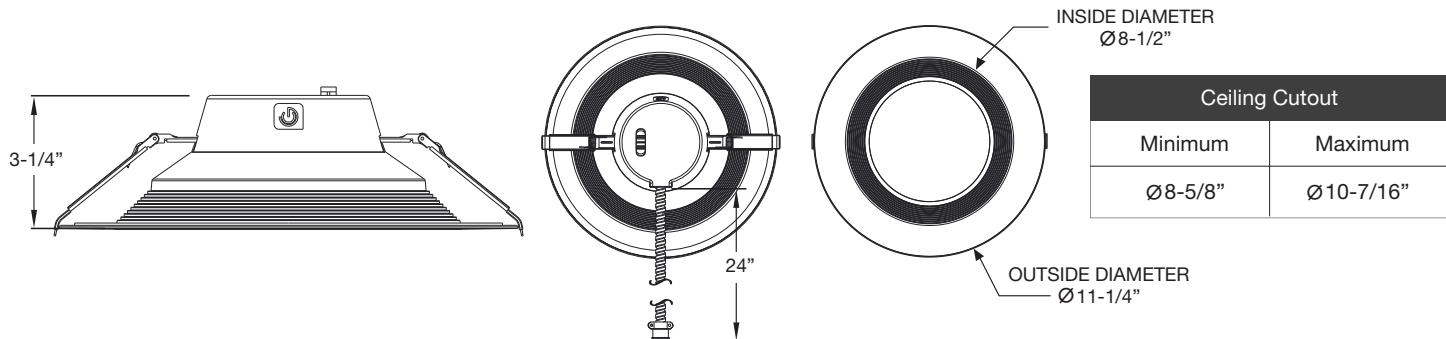

TECHNICAL INFORMATION

Dimming	Input Voltage	Input Frequency	Input Current (Low / Med / High)	Input Power	THD Power	Power Factor
DIM120V	120V	50 / 60Hz	0.145/0.18/0.235A	17/ 21 / 27W	<20%	>0.9
DIM010VUNV	120V	50 / 60Hz	0.145/0.18/0.235A	17/ 21 / 27W	<20%	>0.9
	277V		0.082/0.095/0.115A			

PHOTOMETRY

INFT9.5/835/DIM010UNV (HIGH OUTPUT)

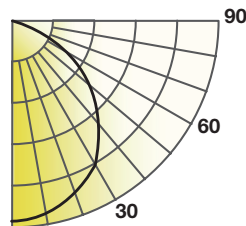

Lumens: 3,595 lm
 CBCP: 1,358 cd
 Power: 26.6 W
 Efficacy: 135 lm/W
 CRI: 80+
 Spacing Criteria: 1.23
 Beam Angle: 108.4°

Candlepower Distribution	
Angle (°)	Average (cd)
0	1,358
5	1,351
15	1,294
25	1,187
35	1,041
45	862
55	654
65	423
75	172
85	10
90	0

Initial Footcandles		
Height (ft)	Fc	Diameter (ft)
8	32	22.2
9	25	25.0
10	20	27.7
12	14	33.3
15	9	41.6









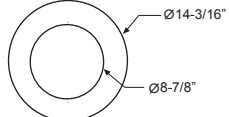

Zonal Lumen Summary		
Zone	Lumens	%Fixture
0-30	1,042	29%
0-40	1,694	47%
0-60	2,954	82%
0-90	3,595	100%

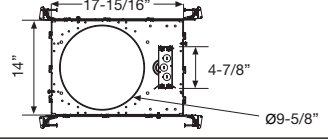
PERFORMANCE

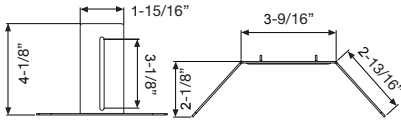
CCT	2700K			3000K			3500K			4000K			5000K		
	Low	Med	High	Low	Med	High	Low	Med	High	Low	Med	High	Low	Med	High
Output	2,040	2,520	3,240	2,090	2,585	3,320	2,125	2,625	3,375	2,160	2,665	3,430	2,160	2,665	3,430
LPW	120	120	120	123	123	123	125	125	125	127	127	127	127	127	127

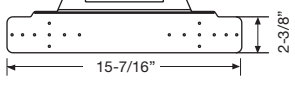

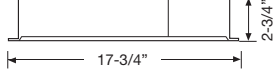
9.5" INNOFIT GEN 2 COMMERCIAL DOWNLIGHT

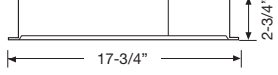
ACCESSORY ORDERING INFORMATION				
Product	Model	Description	Pictures	Dimensions
98566	GOOFRING9.5	9.5" Goof Ring - Outer Diameter 14-3/16"		
35124	NCFJB9.5	9.5" Round New Construction Rough-in Frame with Jbox		
35126	NCFBFB	Field Installable Butterfly Brackets For New Construction Rough-in Frame		
35125	NCFEMB	Field Installable Emergency Bracket For New Construction Rough-in Frame		
58012	35EMINVERTER	35W Emergency Inverter (Field Installation)		
58013	35EMINVERTER/CEC	California Title 20 Compliant 35W Emergency Inverter (Field Installation)		

ORDERING GUIDE

Product	Model
35076	INFT9.5/827/DIM010UNV
35077	INFT9.5/830/DIM010UNV
35078	INFT9.5/835/DIM010UNV
35079	INFT9.5/840/DIM010UNV
35080	INFT9.5/850/DIM010UNV
35116	INFT9.5/827/DIM120V
35117	INFT9.5/830/DIM120V
35118	INFT9.5/835/DIM120V
35119	INFT9.5/840/DIM120V
35120	INFT9.5/850/DIM120V

10 YEAR EXTENDED WARRANTY

Model	INFT9.5/10YEARWARRANTY
-------	------------------------

Note: All rights reserved. All sizes and specifications are subject to change at any time without notice.