

Walkway Lite

| |
|----------|
| PROJECT: |
| TYPE: |
| SOURCE: |
| NOTES: |

PURELED SPECIFICATIONS

| | |
|----------------------------|--|
| LED Chip | Cree XPG-3 Plug and Play field replaceable LED board |
| Luminaire Output | 120 Lumens @ 700mA (2 watts), delivered from luminaire with unobstructed beam. |
| Lumens Per Watt | 60 Lumens minimum @ 4 watts, delivered from luminaire with unobstructed beam |
| CRI (3000K) | 85+ Standard, 90+ Optional |
| Colour Temperatures | 2700K, 3000K, 4000K |
| Beam Angles | Asymmetric |
| Ingress Protection | IP44 |

| | |
|------------------|---|
| Warranty | Electronics = 5 years Body Cop/SS = 10 years |
| Standards | AS/NZS 61046 cUL 1838, 2108 CSA C22.2 No.250.7, No.250.0-08 CE |

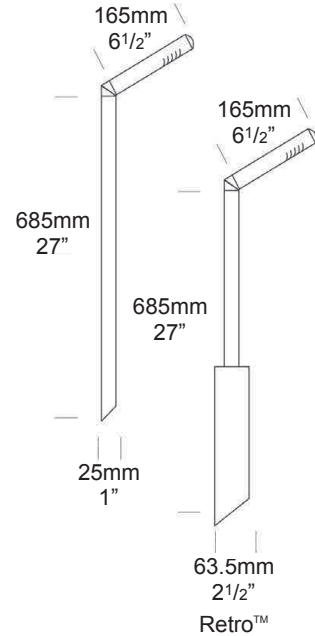

PRODUCT CONFIGURATION

Please fill in appropriate codes into boxes provided

Cat. No. WW/L

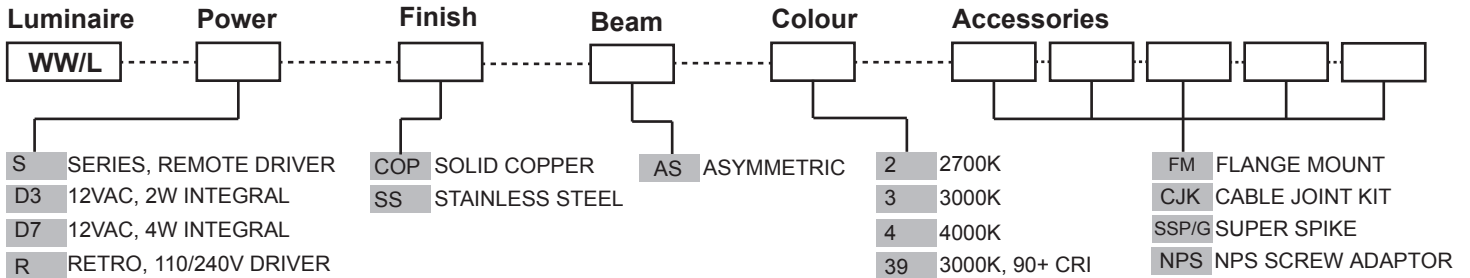

SERIES, REMOTE DRIVER REQUIRED:
Constant current driver
Individual fixtures require 3vdc @ 700mA maximum

12VAC INTEGRAL DRIVER:
Hunza Buckbullet driver (included)
Input: 12VAC, 3watt at 700mA
Output: 3vdc @ D3=350mA, D7=700mA

110/240VAC RETRO DRIVER:
Input: 120/240vac, 3 watt total (included)
Output: 3vdc, 700mA
0-10 volt dimming
(USA - non dimming)

OTHER LAMP OPTIONS:
WW/H - G4 Halogen 12V Lamp
WW/GL - G4 LED Retrofit 12V Lamp (lamps vary by market - please refer to supplier for details)

Please click for Remote Power Supply Guidance Charts:

[USA \(page 3\)](#)
[Rest of the World \(page 3\)](#)

[Click here for halogen specification sheet](#)

LUMINAIRE CONSTRUCTION

CNC machined from one of the following metals:

Copper

Pole: solid copper 25.4mm (1") rod.
End cap: solid copper 25.4mm (1") rod.

316 Stainless Steel

Pole: 316 stainless steel 25.4mm (1") rod.
End cap: 316 stainless steel 25.4mm (1") rod.

Elbow: investment cast in brass or stainless steel

Lens:

22mm (3/4") extra clear low iron flush fit shatter resistant glass tube.
Lifetime warranty.

Gaskets:

Silicone, iron impregnated 220°C (428°F).

Mounting

The pole 685mm (27") is directly mounted into the earth or concrete. For extra stability in sand or loose ground use the Super Spike. Flange Mount option is available for hard surfaces.

Luminaire Weight:

Low voltage
Cop: 1.100kg (2lb 6oz)
SS: 1.100kg (2lb 6oz)
Retro™
Cop: 2.380kg (5lb 3oz)
SS: 2.380kg (5lb 3oz)

ACCESSORIES

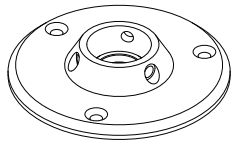

Flange Mount

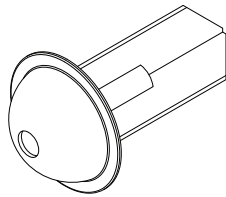

Super Spike

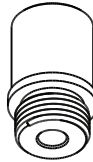

NPS 1/2"
Screw Mount Adaptor

BEAM ANGLES

High efficiency PMMA TIR lenses. Field replaceable

IES files available for download: <http://www.hunzalighting.com/download.php>

WIRING GUIDE

Series/remote driver

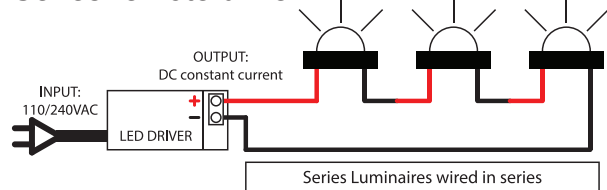

Diagrams are a guide only, wire colours and polarity may change depending on fixture and country

available for download: <http://www.hunzalighting.com/download.php>

12v integral driver

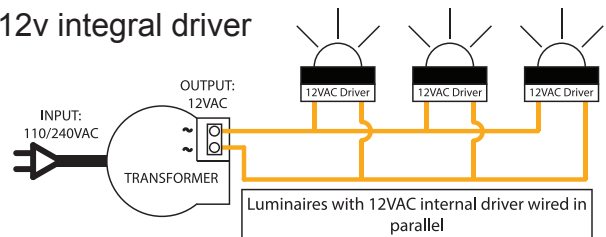

Specifications may change without notification

Aug 2017