



LOW PROFILE 3-1/4" LED RECESSED ADJUSTABLE 800/1200/1500/2000 LUMEN ANGLE CUT CONE TC420LP, IC415LP, IC412LP, IC408LP with 438N Trim

PRODUCT DESCRIPTION

Low Profile recessed adjustable LED luminaire is less than 4" tall with 3 1/4" angle cut cone produces up to 2000 delivered lumens. Fixture has 45° visual cutoff and features precision geared hot-aiming. Available in both IC and Non-IC rated configurations.

PRODUCT SPECIFICATIONS

LED Light Engine Consistent fixture to fixture color within 3-step MacAdam ellipse • 2700K, 3000K, 3500K, or 4000K color temperatures are available with 80 CRI minimum • 2700K and 3000K also available with 90 CRI minimum.

Modular Optics Available with 12° Spot, 24° Narrow Flood, 35° Flood and 50° wide flood field interchangeable optics • Additional distributions of 20°, 30°, 40°, 45° and 60° FWHM can be achieved with the use of the diffusing films and spot primary optic • Patented (US Patent 8,950,911) auto-adjusting optic holder maximizes luminaire efficiency by maintaining optimal LED optic position • Accommodates up to two (2) additional beam control lenses and/or filters.

Adjustability Acu-Aim™ precision geared hot-aiming achieves 370° rotation, 45° tilt • Optimized center beam optics translates light engine forward as it is aimed off nadir, ensuring maximum light and low brightness • Black aiming mechanism preserves dark aperture.

Reflector .040" aluminum angle-cut reflector in clear, black, haze, or wheat haze Alzak finish provides 50° cut-off.

Trims Style Trim Ring, Self Flanged and Flush Mount reflectors utilize torsion spring retention for tight, secure fit to ceiling • Trim ring features beveled knife edge for clean ceiling interface • Self Flanged reflectors with polished or optional white painted flange • For flush mount installations in drywall ceilings use the FMA4 flush mount adapter • For flush mount installations in wood, stone, or tile ceilings the FMA4-SC*** must be used (specify ceiling thickness and adapter finish).

LED Driver Seven (7) driver options available to accommodate 120-277V input and multiple control protocols • For a list of compatible dimmers, refer to [ACLXLED3-DIM](#) • Power Factor > 0.9 • Field replaceable from below or above ceiling.

Life Rated for 50,000 hrs at 70% lumen maintenance.

Warranty 5 years from date of purchase on LED components • Standard Juno Lighting Group product guarantee terms and conditions apply.

Codes/Labels UL and cUL listed for through branch wiring, damp locations • IC housings meet energy code Air Leakage requirements per ASTM E283 • ENERGY STAR® Qualified with select trims • IC rated luminaires with 90CRI light engine are certified to high efficacy requirements of California T24 with select color temperatures and trims • IC housings are rated for direct contact with insulation • IC408LP and IC412LP are compatible with spray foam insulation with an R-Value of 3.7 per inch or less • Union made.

New Construction Mounting Shallow new construction fixture is less than 4" tall for applications with limited space • Features patented (US Patent 8,038,113) Pro-VI™ bar hanger system, permitting quick placement of housing with 24" on-center joists or suspended ceilings and vertically adjustable mounting brackets (butterfly brackets) • Centerline indicators on plaster frame and patented (US Patent 8,277,090) Tru-Line™ Platform featuring +/- 1/2" translation aids fixture alignment after installation, prior to drywall.

Junction Box Rated for 4 No. 12 AWG 90° C through branch circuit conductors and includes (6) 1/2", (1) 3/4", and (4) Non-metallic sheathed cable knock-outs • Push-in electrical connectors for field connections.

Ceiling Thickness 1/2" – 7/8" ceiling standard • For thicker ceilings, order CTA4N-125 (7/8"-1 1/4"), CTA4N-163 (1 1/4"-1 5/8") or CTA4N-200 (1 5/8"-2") • CTA4N not required for wood, stone, or tile flush mount applications.



Type	Cat. No.
_____	_____
Project: _____	
Notes: _____	

DIMENSIONS

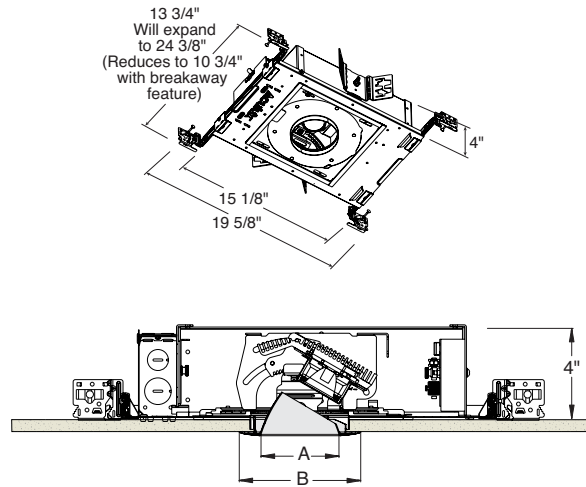

4 1/4" CEILING CUTOUT
(REFER TO INSTRUCTION SHEET FOR
FLUSH MOUNT CEILING CUTOUT)

	A	B
Trim Ring	3 1/4"	5"
Self Flanged	3 3/8"	4 5/8"
Flush Mount	3 3/8"	3 7/8"

ELECTRICAL DATA

Lumen Package	800	1200	1500	2000
Voltage	120 277	120 277	120 277	120 277
Input Power	9.6W 9.7W	15.1W 15.3W	19.8W 19.8W	27.0W 26.7
Input Current	0.08 0.04	0.13 0.06	0.17 0.08	0.23 0.10
Frequency	50/60Hz	50/60Hz	50/60Hz	50/60Hz
Power Factor	>0.9 >0.9	>0.9 >0.9	>0.9 >0.9	>0.9 >0.9

3-1/4" LED RECESSED ADJUSTABLE 800/1200/1500/2000 LUMEN

ANGLE CUT CONE
NEW CONSTRUCTION

**IC/TC420L, IC415L, IC412L, IC408L
with 438N Trim**

Ordering Information Housing, trim and accessories each ordered separately

Example: **IC412LP-830-N-1**

Series	CRI/Color Temperature	Optic	Driver	Options
IC408LP 800 Lumen, IC Rated	827 2700K, 80CRI	S 12° Spot	I 120V, Forward & Reverse Phase Dimming, 5%	CP* Chicago Plenum
IC412LP 1200 Lumen, IC Rated	830 3000K, 80CRI	N 24° Narrow Flood	EZ1 120-277V, eldoLED ECOdrive 0-10V Dimming, 1%	N1¹ nLight® dimming pack, 120V
IC415LP 1500 Lumen, IC Rated	835 3500K, 80CRI	F 35° Flood	EZB 120-277V, eldoLED SOLdrive 0-10V Dimming, 0.1%	N2¹ nLight® dimming pack, 277V
TC420LP 2000 Lumen, Non-IC Rated	840 4000K, 80CRI	W 50° Wide Flood	L 120-277V, Lutron Hi-Lume 3-Wire Dimming, Ecosystem Compatible, 1%	CPNL^{1,2} nLight® dimming pack and Chicago Plenum rated
	927 2700K, 90CRI		D 120V, Lutron Hi-Lume 2-Wire Dimming, 1%	*Chicago Plenum not available on TC420LP
	930 3000K, 90CRI		M 120-277V, DMX512/RDM	¹ Available with eldoLED drivers only
			A 120-277V, DALI Dimming	² nLight® NPS80EZ ships loose for remote mounting

Example: **438NB-WH**

Trim
<input type="text"/>



Trim Ring ¹	Self Flanged ²	Flush Mount ³	Description
438NB-WH	438NB-SF	438NB-FM	Black Cone
438NB-ABZ	-	-	Black Cone
438NB-SC	-	-	Black Cone
438NC-WH	438NC-SF	438NC-FM	Clear Cone
438NHZ-SC	-	-	Haze Cone
438NHZ-WH	438NHZ-SF	438NHZ-FM	Haze Cone
438NWHZ-ABZ	-	-	Wheat Haze Cone
438NWHZ-WH	438NWHZ-SF	438NWHZ-FM	Wheat Haze Cone

¹Trim Ring Finish: ABZ - Classic Aged Bronze, SC - Satin Chrome, WH - White.
²For self flanged reflector with optional white painted flange, replace "SF" suffix with "SFWH".
³Flush Mount trims must be used with Flush Mount Adapter, ordered separately.
 Product specifications subject to change without notice.

	Construction:	Type IC & Non-IC
	CCT/CRI:	827, 830, 835, 840, 930
	Optic:	S, N, F, W
	Trim Finish:	C, HZ, WHZ

	Construction:	Type IC
	CCT/CRI:	927, 930
	Optic:	S, N, F, W
	Trim Finish:	C, HZ, WHZ

3-1/4" LED RECESSED ADJUSTABLE 800/1200/1500/2000 LUMEN

ANGLE CUT CONE
NEW CONSTRUCTION

IC/TC420L, IC415L, IC412L, IC408L
with 438N Trim

To achieve the desired beam angle (FWHM), specify the following primary LED optic on the luminaire and order the diffusing film from the table below

Desired FWHM	Primary Optic	Film
12°	S	-
20°	S	AF3-10
24°	N	-
30°	S	AF3-20
35°	F	-
40°	S	AF3-30
45°	S	AF3-40
50°	W	-
60°	S	AF3-50
20°x60°	S	AF3-60x1

Flush Mount Adapters

Cat. #	Description
FMA4	Drywall Ceiling Adapter
FMA4-SC087-WH	Wood, Stone, Tile, 1/2"-7/8" Thick Ceiling, Adapter, White
FMA4-SC087-BL	Wood, Stone, Tile, 1/2"-7/8" Thick Ceiling, Adapter, Black
FMA4-SC125-WH	Wood, Stone, Tile, 7/8"-1 1/4" Thick Ceiling, Adapter, White
FMA4-SC125-BL	Wood, Stone, Tile, 7/8"-1 1/4" Thick Ceiling, Adapter, Black
FMA4-SC163-WH	Wood, Stone, Tile, 1 1/4"-1 5/8" Thick Ceiling, Adapter, White
FMA4-SC163-BL	Wood, Stone, Tile, 1 1/4"-1 5/8" Thick Ceiling, Adapter, Black

Optical Accessories

Cat. #	Description	Cat. #	Description
TIR-ACLX3-SP	12° Spot Optic	T746	Med. Green Color Filter
TIR-ACLX3-NFL	24° Narrow Flood Optic	T7401	Red Dichroic Lens
TIR-ACLX3-FL	35° Flood Optic	T7403	Med. Green Dichroic Lens
TIR-ACLX3-WFL	50° Wide Flood Optic	T7404	Med. Blue Dichroic Lens
AF3-10	10° Film (Use with Spot Optic)	T7405	Yellow Dichroic Lens
AF3-20	20° Film (Use with Spot Optic)	T7406	Magenta Dichroic Lens
AF3-30	30° Film (Use with Spot Optic)	T7411	Blue Green Dichroic Lens
AF3-40	40° Film (Use with Spot Optic)	T7416	Daylight Blue Correction Lens
AF3-50	50° Film (Use with Spot Optic)	T7420	Diffuse Spread Lens
AF3-60x1	60°x1° Film (Use with Spot Optic)	T7421	Uniformity Lens
T741	Med. Pink Color Filter	T7422	UV Filter Lens
T742	Warm Red Color Filter	T7477	Prismatic Lens
T743	Daylight Blue Color Filter	T7478	Linear Spread Lens
T744	Med. Blue Color Filter	T7459BL	Hexcell Louver
T745	Med. Amber Color Filter		

Product specifications subject to change without notice.

Misc. Accessories

Cat. #	Description
CTA4N-125	1 1/4" Thick Ceiling Adapter
CTA4N-163	1 5/8" Thick Ceiling Adapter
CTA4N-200	2" Thick Ceiling Adapter
HB-1	(2) Real Nail 3 Bar Hangers
HB-26	(2) 26" C-Channel Bar Hangers
HB-50	(2) 50" C-Channel Bar Hangers
LB-27	(2) 27" Linear Bar Hangers
EMI-20	20W Emergency Lighting Inverter

To order, specify catalog number.



3-1/4" LED RECESSED ADJUSTABLE 800/1200/1500/2000 LUMEN

ANGLE CUT CONE
NEW CONSTRUCTION

IC/TC420L, IC415L, IC412L, IC408L
with 438N Trim

SPOT PHOTOMETRIC REPORT

Test Report: PTO4152501
Catalog No: IC/TC420L-830-S-1
(Aim at 30°)
with 438NC trim

Watts: 26.2
Lumens: 1847
Luminaire LPW: 70

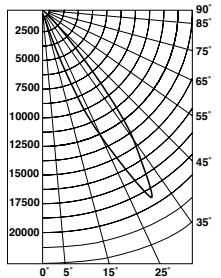

Candlepower Distribution (Candelas)

Degrees	Vertical Candela
0°	440
5°	358
10°	937
15°	1941
20°	5893
25°	13906
30°	19322
35°	14239
40°	6103
45°	1659
50°	165
55°	52
60°	7
65°	1
70°	0
75°	0
80°	0
85°	0
90°	0

NARROW FLOOD PHOTOMETRIC REPORT

Test Report: PTO4152701
Catalog No: IC/TC420L-830-N-1
(Aim at 30°)
with 438NC trim

Watts: 26.2
Lumens: 1918
Luminaire LPW: 73

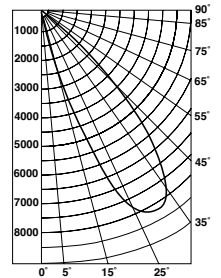

Candlepower Distribution (Candelas)

Degrees	Vertical Candela
0°	514
5°	497
10°	880
15°	2232
20°	4959
25°	7292
30°	8215
35°	7774
40°	6177
45°	3722
50°	984
55°	143
60°	55
65°	2
70°	0
75°	0
80°	0
85°	0
90°	0

FLOOD PHOTOMETRIC REPORT

Test Report: PTO4152801
Catalog No: IC/TC420L-830-F-1
(Aim at 30°)
with 438NC trim

Watts: 26.2
Lumens: 1936
Luminaire LPW: 74

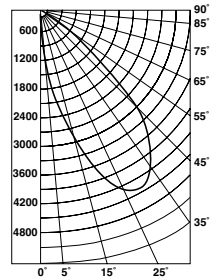

Candlepower Distribution (Candelas)

Degrees	Vertical Candela
0°	567
5°	1156
10°	1934
15°	2926
20°	3773
25°	4225
30°	4360
35°	4164
40°	3713
45°	3009
50°	1842
55°	991
60°	488
65°	7
70°	0
75°	0
80°	0
85°	0
90°	0

WIDE FLOOD PHOTOMETRIC REPORT

Test Report: PTO4152901
Catalog No: IC/TC420L-830-W-1
(Aim at 30°)
with 438NC trim

Watts: 26.2
Lumens: 1716
Luminaire LPW: 65

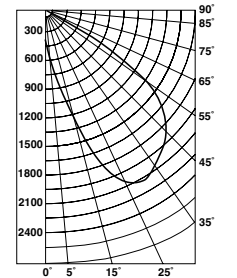

Candlepower Distribution (Candelas)

Degrees	Vertical Candela
0°	427
5°	615
10°	906
15°	1292
20°	1735
25°	2032
30°	2126
35°	2074
40°	1989
45°	1906
50°	1771
55°	1345
60°	673
65°	13
70°	1
75°	0
80°	0
85°	0
90°	0

LUMEN OUTPUT MULTIPLIERS

Color Temperature	CRI	Multiplier	Lumen Package	Multiplier
2700K	80	0.95	800	0.40
3000K	80	1.00	1200	0.61
3500K	80	1.05	1500	0.75
4000K	80	1.10	2000	1.00
2700K	90	0.83		
3000K	90	0.87		

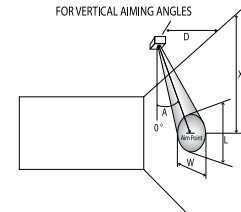
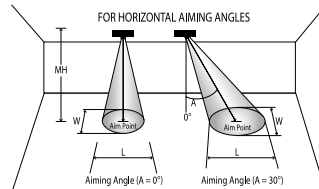

CBCP • Centerbeam candlepower
FC • Footcandles at beam center (aim point)

In vertical aiming applications, aim point (X) is determined by dividing distance from the wall (D) by the tangent of the desired aim angle (A) (0.5774 for 30°, 1.0 for 45°).

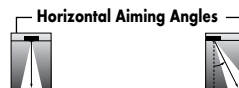

Beam Type	Beam Spread	CBCP	0°			30°			30°			45°						
			MH	FC	L	W	FC	L	W	D	FC	X	L	W	FC	X	L	W
SPT	12°	19322	6	537	1.6	1.6	349	2.1	1.8	3	268	5.2	3.5	1.6	759	3.0	1.6	1.1
			8	302	2.1	2.1	196	2.8	2.4	4	151	6.9	4.5	2.1	427	4.0	2.2	1.5
			10	193	2.7	2.7	126	3.6	3.1	5	97	8.7	5.6	2.7	273	5.0	2.7	1.9
			12	134	3.2	3.2	87	4.3	3.7	6	67	10.4	6.7	3.2	190	6.0	3.2	2.2
			14	99	3.7	3.7	64	5.0	4.3	7	49	12.1	7.8	3.7	139	7.0	3.8	2.6
NFL	24°	8215	4	513	1.8	1.8	333	2.5	2.1	2	257	3.5	4.4	1.8	726	2.0	1.9	1.3
			6	228	2.8	2.8	148	3.7	3.2	3	114	5.2	6.6	2.8	323	3.0	2.9	2.0
			8	128	3.7	3.7	83	5.0	4.2	4	64	6.9	8.7	3.7	182	4.0	3.9	2.6
			10	82	4.6	4.6	53	6.2	5.3	5	41	8.7	10.9	4.6	116	5.0	4.9	3.3
FL	35°	4360	12	57	5.5	5.5	37	7.5	6.4	6	29	10.4	13.1	5.5	81	6.0	5.8	3.9
			4	273	2.7	2.7	177	3.8	3.2	2	136	3.5	8.4	2.7	385	2.0	3.1	1.9
			6	121	4.1	4.1	79	5.7	4.7	3	61	5.2	12.6	4.1	171	3.0	4.6	2.9
			8	68	5.5	5.5	44	7.6	6.3	4	34	6.9	16.8	5.5	96	4.0	6.2	3.9
WFL	50°	2126	10	44	6.8	6.8	28	9.5	7.9	5	22	8.7	21.0	6.8	62	5.0	7.7	4.8
			12	30	8.2	8.2	20	11.4	9.5	6	15	10.4	25.2	8.2	43	6.0	9.3	5.8
			4	133	4.1	4.1	86	6.0	4.7	2	66	3.5	37.5	4.1	188	2.0	5.5	2.9
			6	59	6.1	6.1	38	8.9	7.1	3	30	5.2	56.3	6.1	84	3.0	8.3	4.3
			8	33	8.2	8.2	22	11.9	9.4	4	17	6.9	75.0	8.2	47	4.0	11.1	5.8
			10	21	10.2	10.2	14	14.9	11.8	5	11	8.7	93.8	10.2	30	5.0	13.9	7.2
			12	15	12.3	12.3	10	17.9	14.2	6	7	10.4	112.5	12.3	21	6.0	16.6	8.7

