



4" LOW VOLTAGE UNIVERSAL TC HOUSING

Project: _____

Fixture Type: _____

Location: _____

Contact/Phone: _____

75W MR16
TC47

PRODUCT DESCRIPTION

TC Housing design for use in non-insulated areas • If installed where insulation is present, the insulation must be pulled back 3" from all sides of the TC housing.

PRODUCT SPECIFICATIONS

Lamp One 12V, 75W MR16 lamp (certain trims limited to 50W - see trim selection).

Socket Ceramic bi-pin socket with aluminum heat shield.

Trims Trim selection shown on reverse.

Transformer 120V to 12V 75VA thermally protected magnetic transformer mounted to junction box.

Dimming May be dimmed using dimmers specifically designed for low voltage magnetic transformers; consult factory or dimmer manufacturer for additional information.

Labels U.L. listed for through-branch wiring, damp locations and IP • Product thermally protected against improper use of lamps or insulation • Union made • UL Listed/CSA certified • Trim No. 441 is wet location approved for covered ceiling applications.

Testing All reports are based on published industry procedures; field performance may differ from laboratory performance.

Product specifications subject to change without notice.

INSTALLATION

Real Nail 3 Bar Hangers Telescoping, Patented (US Patent D552,969) Real Nail 3 system permits quick placement of housing anywhere within 24" O.C. joists or suspended ceilings • Integral T-bar notch and clip secures housing in suspended ceiling grid – no accessory clips required • 24" expansion stop allows quick placement of fixture in standard grid spacing • Bars scored in two locations for fast, clean breaking, allowing housing installation in tight applications • Bars captive to mounting frame • Edge-mounted for extra strength • Captive bugle-headed ring shank nail for quick one-step installation and easy removal with claw hammer for fixture relocation • Quick-Loc slot and oversized locking set screw lock fixture in position • Bar hanger foot contoured to align to bottom of construction joist • Alternate mounting holes included.

Junction Box Pre-wired junction box provided with (5) ½" and (1) ¾" knockouts, (4) Non-metallic sheathed cable connectors and ground wire, U.L. listed/CSA certified for through branch wiring, maximum 8 No. 12 AWG 90° C branch circuit conductors (4 in, 4 out) • Junction box provided with removable access plates • Knockouts equipped with pryout slots.

Mounting Frame 22-gauge die-formed galvanized steel mounting frame • Rough-in section (junction box, mounting frame, housing and bar hangers) fully assembled for ease of installation.

Housing TC housing, .040" thick aluminum • Housing is vertically adjustable to accommodate up to a 1" ceiling thickness.

DIMENSIONS

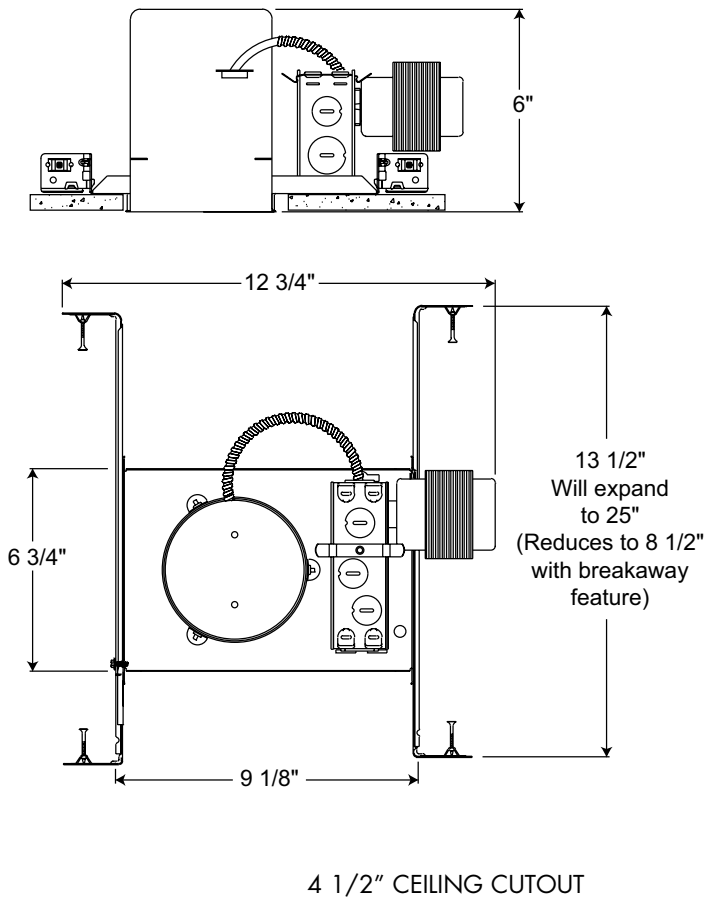

ACCESSORIES

Catalog No.	Description
4TSA	Torsion Spring Adapter (for original style housing)

To order, specify catalog number.







PRODUCT CODES

Catalog Number	Input Voltage	Lamp Rating (max.)
TC47	120V	12V 75W MR16



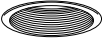

4" LOW VOLTAGE UNIVERSAL TC HOUSING

75W MR16
TC47

TRIMS (MAXIMUM 12V 75W MR16)

Cat. No.	Description	Cat. No.	Description
 443B-WH	Pinhole with Black Baffle Downlight	 447C-WH	Downlight or Adjustable - Clear Alzak®
 444B-WH	Downlight or Adjustable with Black Baffle	447G-WH	Downlight or Adjustable - Gold Alzak®
444B-SC	Downlight or Adjustable with Black Baffle	447B-WH	Downlight or Adjustable - Black Alzak®
444B-ABZ	Downlight or Adjustable with Black Baffle	447PT-SC	Downlight or Adjustable - Pewter Alzak®
444B-BL	Downlight or Adjustable with Black Baffle	447HZ-WH	Downlight or Adjustable - Haze
444W-WH	Downlight or Adjustable with White Baffle 35° Vertical Adjustment	447WHZ-WH	Downlight or Adjustable - Wheat Haze
 445-WH	Slot Aperture Downlight or Adjustable 50° Vertical Adjustable	 448-WH	Eyeball with Black Baffle
 446-WH	Scoop Adjustable 50° Vertical Adjustable	448-SC	Eyeball with Black Baffle 35° Vertical Adjustment
		 XR16101WH	AVIO Square Gimbal Ring - White
		XR16101BL	AVIO Square Gimbal Ring - Black
		XR16101GP	AVIO Square Gimbal Ring - Graphite
		XR16101SL	AVIO Square Gimbal Ring - Silver

TRIMS (MAXIMUM 12V 50W MR16)

Cat. No.	Description	Cat. No.	Description
 440-WH	Flush Gimbal Ring - White	 449-WH	75° Aiming Adjustable
440-BL	Flush Gimbal Ring - Black	449-BL	75° Vertical Adjustment
440-SC	Flush Gimbal Ring - Satin Chrome	449-SC	
440-ABZ	Flush Gimbal Ring - Classic Aged Bronze 40° Vertical Adjustment	449-ABZ	
 441W-WH ◆	Adjustable Shower Trim, frosted lens with clear center		
441W-SC ◆	Adjustable Shower Trim, frosted lens with clear center		
441W-ABZ ◆	Adjustable Shower Trim, frosted lens with clear center 35° Vertical Adjustment		
 442C-WH	Deep Cone Downlight - Clear Alzak®		
442G-WH	Deep Cone Downlight - Gold Alzak®		
442B-WH	Deep Cone Downlight - Black Alzak®		
442HZ-WH	Deep Cone Downlight - Haze		
442WHZ-WH	Deep Cone Downlight - Wheat Haze		

Note: Lamps may be dimmed. Use dimmers specifically designed for low voltage magnetic transformers; consult factory or dimmer manufacturer for additional information.

Trim Size: 5" O.D.

Trim Finish: ABZ - Classic Aged Bronze, BL - Black, GP - Graphite,
PW - Plastic White (Polycarbonate material shower trim), SC - Satin Chrome, SL - Silver, WH - White.
Alzak is a registered trademark of Alcoa Corp.

◆ UL Listed for use in wet location.