

KICHLER®

52" Colerne LED

Product images may vary slightly from actual product.



INSTRUCTION MANUAL

TABLE OF CONTENTS

SAFETY RULES	4	ATTACHING THE FAN BLADES	12
TOOLS REQUIRED	5	INSTALLING THE SWITCH HOUSING	13
PACKAGE CONTENTS	5	INSTALLING THE LIGHT KIT AND GLASS	14
MOUNTING OPTIONS	6	INSTALLING THE WALL CONTROL	15
HANGING THE FAN	7	CONTROL SYSTEM SET-UP	16
INSTALLATION OF SAFETY SUPPORT	9	OPERATING INSTRUCTIONS	17
ELECTRIC CONNECTIONS	10	TROUBLESHOOTING.....	18
FINISHING THE INSTALLATION	11	FCC WARNING.....	19

SAFETY RULES

1. To reduce the risk of electric shock, insure electricity has been turned off at the circuit breaker or fuse box before beginning.
2. All wiring must be in accordance with the National Electrical Code (NEC) and local electrical codes. Electrical installation should be performed by a qualified licensed electrician.
3. **WARNING:** Suitable for use with solid-state speed controls.
4. **WARNING:** To reduce the risk of personal injury, use only the two steel screws (and lock washers) provided with the outlet box for mounting to the outlet box. Most outlet boxes commonly used for the support of lighting fixtures are not acceptable for fan support and may need to be replaced, consult a qualified electrician if in doubt.
5. To operate the reverse function on this fan, press the reverse button while the fan is running.
6. Avoid placing objects in the path of the blades.
7. To avoid personal injury or damage to the fan and other items, be cautious when working around or cleaning the fan.
8. Do not use water or detergents when cleaning the fan or fan blades. A dry dust cloth or lightly dampened cloth will be suitable for most cleaning.
9. After making the electrical connections, spliced conductors should be turned upward and pushed carefully up into outlet box. The wires should be spread apart with the ground wire and white (common) wire to one side with the black (load) wire to the other side of the outlet box.
10. Electrical diagrams are reference only. Light kits that are not packed with the fan must be ETL Listed and marked suitable for use with the model fan you are installing. Switches must be ETL General Use Switches. Refer to the Instructions packaged with the light kits and switches for proper assembly.

WARNING

TO REDUCE THE RISK OF PERSONAL INJURY, DO NOT BEND THE BLADE

BRACKETS (ALSO REFERRED TO AS FLANGES) DURING ASSEMBLY OR AFTER

INSTALLATION. DO NOT INSERT OBJECTS IN THE PATH OF THE BLADES.

TOOLS REQUIRED

- Phillips screwdriver
- Blade screwdriver
- 11 mm wrench
- Step ladder
- Wire cutters

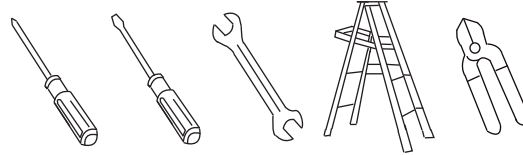

PACKAGE CONTENTS

Unpack your fan and check the contents . You should have the following items:

- A. Mounting bracket
- B. Ball / downrod assembly
- C. Canopy
- D. Canopy Hole Cover
- E. Decoration Ring
- F. Coupling Cover
- G. Motor Body
- H. Fan Blade (5)
- I. Blade Arm (5)
- J. Switch Housing
- K. Light Kit
- L. Glass Assembly
- M. Wall Control System

- N. Package hardware
- 1) Mounting hardware :
Wood screw (2) ,Flat Washer (2) , Screw (2) ,
Lock washer (2), Wire Connector (3)
- 2) Blade attachment hardware :
Screws (17) , Washers (17)
- 3) Safety cable hardware :
Wood screw (1) ,Spring washer (1),
Flat washer (1)
- 4) Balance kit
- 5) Light Kit hardware: screw (3)
- 6) Blade Arm hardware: Screw (2)

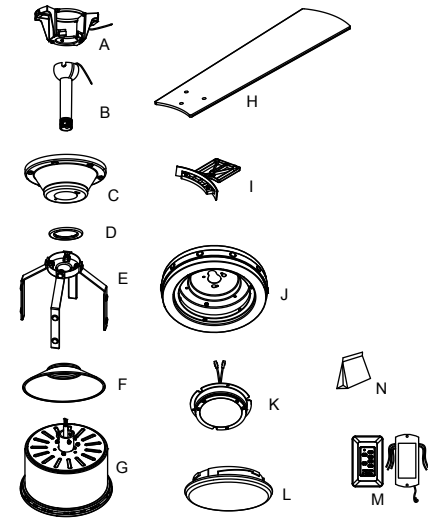

MOUNTING OPTIONS

If there isn't an existing UL (cUL for Canadian Installation) listed mounting box, then read the following instructions. Disconnect the power by removing fuses or turning off circuit breakers.

Secure the outlet box directly to the building structure. Use appropriate fasteners and building materials. The outlet box and its support must be able to fully support the moving weight of the fan (at least 50 lbs). Do not use plastic outlet boxes.

Figures 1, 2 and 3 are examples of different ways to mount the outlet box.

NOTE: If you are installing the ceiling fan on a sloped (vaulted) ceiling, you may need a longer downrod to maintain proper clearance between the tip of the blade and the ceiling. A minimum clearance of 12" is suggested for optimal operation.

NOTE: Depending on the location you have selected for installation, you may need to purchase and install a "Joist Hanger" for the support of the outlet box. Make sure the joist hanger you purchase has been designed for use with ceiling fans. (Fig. 4)

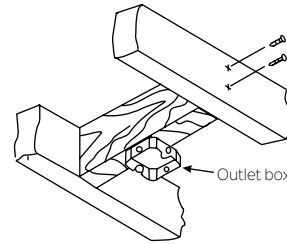

Fig. 1

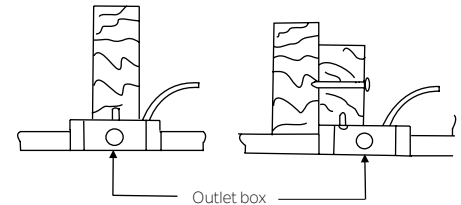

Fig. 2

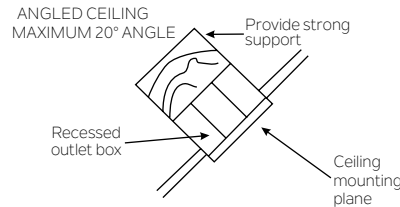

Fig. 3

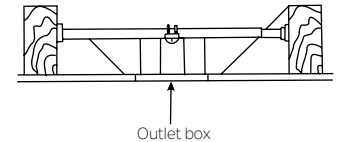

Fig. 4

HANGING THE FAN

REMEMBER to turn off the power before you begin installation. This is necessary for your safety and also the proper programming of the control system. To properly install your ceiling fan, follow the steps below.

Step 1. Before attaching fan to outlet box (not included), ensure the outlet box is securely fastened to at least two points to a structural ceiling member (a loose box will cause the fan to wobble). Pass the 120 volt supply wires from the ceiling outlet box through the center of the ceiling mounting bracket. Install mounting bracket to outlet box in ceiling using the screws and washers included with the outlet box or screws and washers in the hardware bag. (Fig. 5)

Step 2. Remove the hanger ball from downrod assembly by loosening set screws, removing the cross pin, and sliding ball off the rod. (Fig. 6)

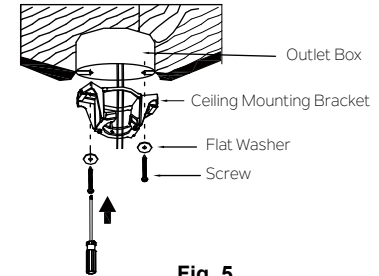

Fig. 5

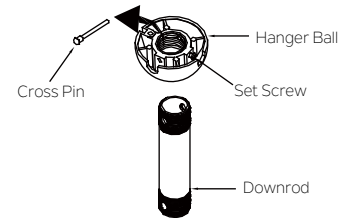

Fig. 6

HANGING THE FAN

Step 3. Loosen the two set screws and remove the cross pin and chip from the top coupling of the motor body. Carefully feed the fan wires and safety cable up through the downrod. Thread the downrod onto the motor coupling until the cross pin holes are aligned. Next, replace the cross pin and clip, and tighten both set screws. (Fig. 7)

Step 4. Slip the coupling cover, decoration ring canopy hole cover and canopy onto the downrod. Carefully reinstall the hanger ball onto the downrod. Make sure the cross pin is in the correct position and the set screw is tight and the wires are not twisted. (Fig. 8)

Step 5. Now lift the motor body into position and place the hanger ball into the hanger bracket. Rotate until the "Check Tab" has dropped into the "Registration Slot" and seats firmly. (Fig. 9) The entire motor body should not rotate if this is done correctly.

WARNING: Failure to properly seat the "Check Tab" can damage the ceiling fan during operation.

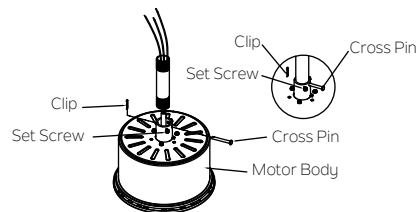

Fig. 7

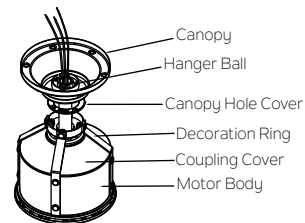

Fig. 8

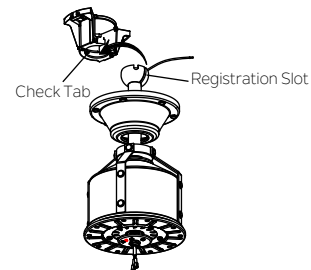

Fig. 9

INSTALLATION OF SAFETY SUPPORT (required for Canadian installation ONLY)

A safety support cable is provided to help prevent the ceiling fan from falling, please install it as follows.

Step 1. Drive a wood screw and washers into the side of the brace that holds the outlet box. Leave 3mm (1/8") of space between the support brace and the washer. (Fig. 10)

Step 2. Insert the safety cable through the mounting bracket and one of the holes in the outlet box into the ceiling. Adjust the length of the safety cable to reach the screw and washers by pulling the extra cable through the cable clamp until the overall length is correct, put the end of the cable back through the cable clamp, forming a loop at the end of the cable. Tighten the cable clamp securely. Now, put the loop in the end of the safety cable over the wood screw and under the washer. Tighten the wood screw securely. (Fig. 11)

NOTE: Although the safety support cable is required for Canadian installations only. It's a good idea to make the attachment with any installation.

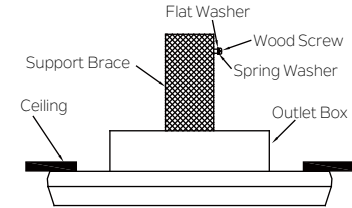

Fig. 10

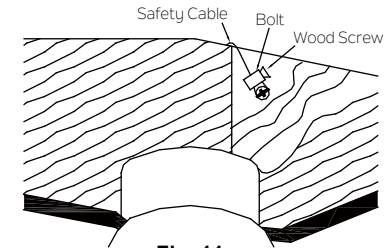

Fig. 11

MAKE THE ELECTRIC CONNECTIONS

WARNING: To avoid possible electrical shock, be sure you have turned off the power at the main circuit panel before wiring. Follow the steps below to connect the fan to your household wiring. Use the wire connecting nuts supplied with your fan. Secure the connector with electrical tape. Make sure there are no loose wire stands or connections.

WARNING: If your house wires are different colors than referenced in this manual, stop immediately. A professional electrician is recommended to determine proper wiring.

Step 1. Insert the receiver into the mounting bracket, and keep flat in opposition of ceiling. (Fig. 12)

Step 2. Motor to Receiver Electrical Connections: Connect the BLACK wire from the fan to BLACK wire marked "TO MOTOR L" from the receiver. Connect the WHITE wire from the fan to the WHITE wire marked "TO MOTOR N" from the receiver. Connect the BLUE wire from the fan to the BLUE wire marked "FOR LIGHT" from the receiver. Secure all the wire connections with the plastic wire nuts provided. (Fig. 13)

Step 3. Remote Receiver to Outlet Box Electrical Connections: Connect the BLACK (hot) wire from the ceiling to the BLACK wire marked "AC IN L" from the wall control. Connect the WHITE (Neutral) wire from the ceiling to the WHITE wire marked "AC IN N" from the receiver. Connect the BLACK (To Motor L) wire from the wall control to the BLACK wire marked "AC IN L" from the receiver. Secure the wire connections with the plastic wire connectors provided. (Fig. 13)

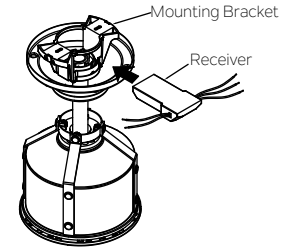

Fig. 12

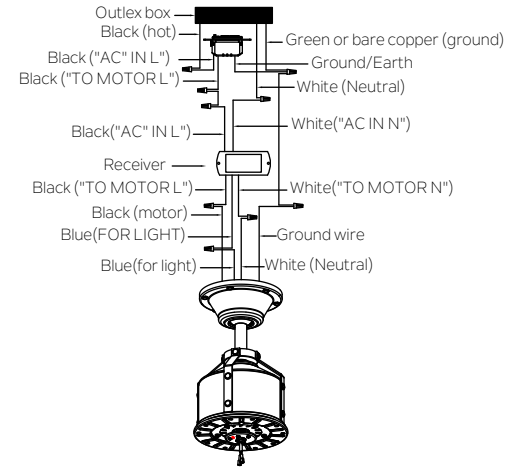

Fig. 13

MAKE THE ELECTRIC CONNECTIONS

Step 4. If your outlet box has a ground wire (green or bare copper) connect it to the fan ground wires : otherwise connect the fan ground wire to the mounting bracket. Secure the wire connection with a plastic nut provided. After connecting the wires, spread them apart so that the green and white wires are on one side of the outlet box and black and blue wires are on the other side. (Fig. 13)

NOTE: Carefully tuck the wire connections up into the outlet box.

NOTE: Fan must be installed at a maximum distance of 30 feet from the transmitting unit for proper signal transmission between the transmitting unit and the fan's receiving unit.

FINISHING THE INSTALLATION

Step 1. Remove one of the two shoulder screws in the mounting bracket. Loosen the second shoulder screw without fully removing it. (Fig. 14)

Step 2. Assemble canopy by rotating key slot in canopy over shoulder screw in mounting bracket. Reinstall the shoulder screw that was previously removed, then retighten two shoulder screws securely.(Fig.15)

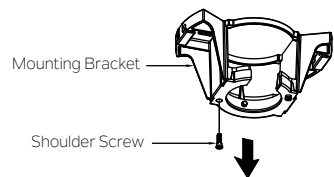

Fig. 14

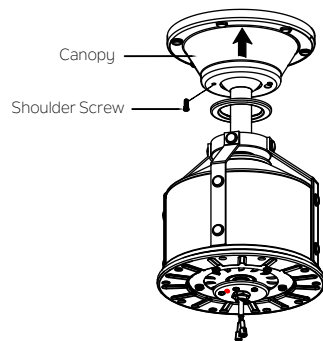

Fig. 15

FINISHING THE INSTALLATION

Step 3. Securely attach and tighten the canopy hole cover over the shoulder screws in the mounting bracket utilizing the keyslot twist-lock feature. (Fig. 16)

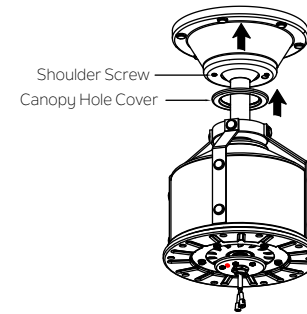

Fig. 16

ATTACHING THE FAN BLADES

NOTE: Before continuing, make sure the power is disconnected by turning off the circuit breaker or removing the fuse at the circuit box.

Step 1. Position the blade over the blade arm with threaded posts showing. Make sure the bottom edge of the blade is fully seated against the blade arm. With a Phillips screwdriver, start a blade screw and washer into the blade arm (do not tighten) and repeat for the 2 remaining blade screws and washers. Tighten each screw securely starting with the center screw. Make sure the blade is straight. Repeat steps for the remaining blades. (Fig. 17)

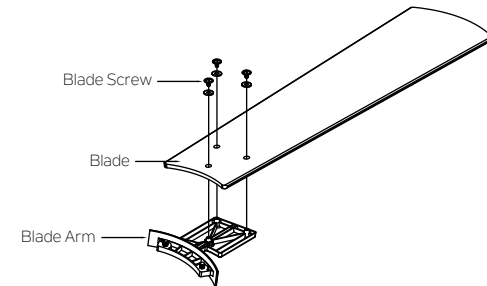

Fig. 17

ATTACHING THE FAN BLADES

Step 2. Fasten blade assembly to the holes located on the bottom of the flywheel. Tighten the two "pre- installed" motor screws in the blade arm. Repeat steps for the remaining blades assemblies.(Fig. 18)

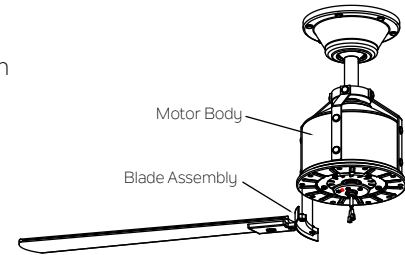

Fig. 18

INSTALLING THE SWITCH HOUSING

Step 1. Remove the screw marked with a dot label which preinstalled on mounting plate and Keep for later use. Loosen the other two (do not remove). Place the two slot holes on the switch housing over the 2 screws previously loosened from the mounting plate. Rotate the switch housing until it locks in place at the narrow end of the key holes. Securely by tightening the 2 screws previously loosened and the one previously removed. (Fig. 19)

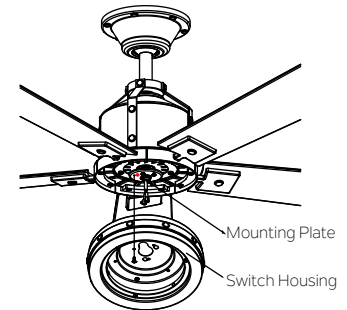

Fig. 19

INSTALLING THE LIGHT KIT AND GLASS

NOTE: Before continuing installation, confirm that the power is still turned off at the main circuit breaker or by removing the correct fuse. Turning the power off using a wall switch is not sufficient to prevent electrical shock.

Step 1. Hold the light kit close to the switch housing and connect the WHITE wires from the light kit and fan by pushing the connectors together. Follow the same procedure with the BLACK wires. (Fig. 20)

Step 2. Tuck the connections neatly into the light kit. Align three round holes on the light kit and switch housing. Securely tighten with 2 screws found in light kit hardware pack. (Fig. 20)

Step 3. Secure the glass to light kit by twisting in a clockwise direction. Do not over-tighten. (Fig. 21)

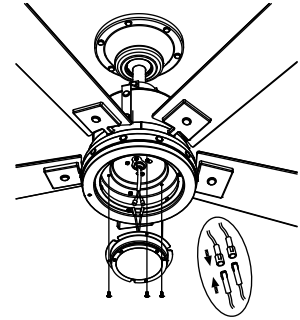

Fig. 20

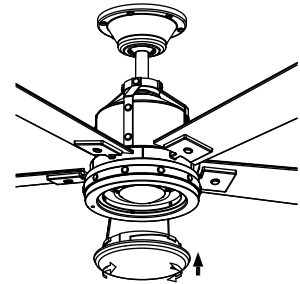

Fig. 21

INSTALLING THE WALL CONTROL

All wiring must be in accordance with the National Electrical Code and local electrical codes. Electrical installation should be performed by a qualified licensed electrician. Select a location to install your wall control. You can replace an existing wall switch, or install the wall control on ANY flat surface.

NOTE: SWITCH INSTALLATION MUST COMPLY WITH ALL LOCAL AND NATIONAL ELECTRIC CODE .

Step 1. Remove the existing wall plate and the old switch from the wall outlet box. Wire nut the BLACK leads (hot) together and push back inside the outlet box. (Fig. 22) or select the desired location with a new wall outlet box.

Step 2. Use the screws provided to secure the wall control to the outlet box.(Fig. 23)

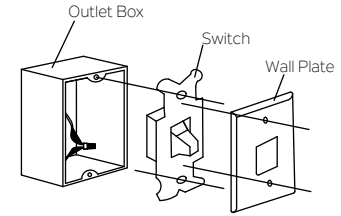

Fig. 22

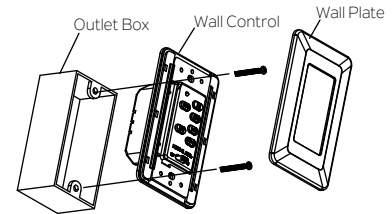

Fig. 23

CONTROL SYSTEM SET-UP

Step 1. After installation is complete, press the LEARN button for 3 seconds within 30 seconds of AC power is turned on. Fan will turn on at medium speed and light (if installed) will turn on. This confirms that the SMART SYNC setting is active and ok. (Fig. 24)

Step 2. If you cannot finish the setting within the 30 seconds time frame, the main power must be turned off and re-started again. This will repeat step 1 until the LEARN feature is activated as indicated.

OPERATING INSTRUCTIONS

Restore power to ceiling fan and test for proper operation (Fig. 24)

1. Fan Control: To start the fan. Press the selected speed button to run the fan at the desired speed: Hi-high speed; MED-medium speed; LOW-low speed; Press the "FAN OFF" button to turn off the fan.
2. Light button: Press once to turn the light on or off. Continuous pressure on the light button dims light in a continuous cycle from light to dark, or dark to light.
3. REV button: Controls direction, forward or reverse.
4. If your ceiling fan has fluorescent lighting, please slide the switch to "O" position. If the ceiling fan has incandescent or halogen lighting or LED, please slide the switch to "D" position.

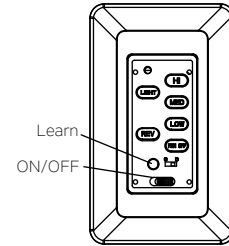

Fig. 24

TROUBLESHOOTING

Problem

Solution

Fan will not start.

1. Check circuit fuses or breakers.
2. Check all electrical connections to insure proper contact. **CAUTION:** Make sure the main power is OFF when checking any electrical connection.
3. Make sure the transmitter batteries are installed properly. Positive (+) side facing out.
4. Insure the batteries have a good charge.

Fan sounds noisy.

1. Make sure all motor housing screws are snug.
2. Make sure the screws that attach the fan blade brackets to the motor are tight.
3. Make sure wire nut connections are not rubbing against each other or the interior wall of the switch housing. **CAUTION:** Make sure main power is off.
4. Allow a 24-hour "breaking-in" period. Most noise associated with a new fan disappear during this time.
5. If using an optional light kit, make sure the screws securing the glassware are tight. Make sure the light bulbs are not touching any other component.
6. Do not connect this fan to a wall mounted variable speed control(s). They are not compatible with ceiling fan motors or remote controls.
7. Make sure the upper canopy is a short distance from the ceiling. It should not touch the ceiling.

Fan wobble.

1. Check that all blade and blade arm screws are secure.
2. Most fan wobbling problems are caused when blade levels are unequal. Check this level by selecting a point on the ceiling above the tip of one of the blades. Measure this distance. Rotate the fan until the next blade is positioned for measurement. Repeat for each blade. The distance deviation should be equal within 1/8".
3. Use the enclosed Blade Balancing Kit if the blade wobble is still noticeable.
4. If the blade wobble is still noticeable, interchanging two adjacent (side by side) blades can redistribute the weight and possibly result in smoother operation.

TROUBLESHOOTING

Problem

Solution

Remote control malfunction.

1.Ceiling Fans with remote control systems CAN NOT be operated in conjunction with any other control system EXCEPT a basic On/Off wall switch, if desired.

FCC WARNING

This device complies with part 15 of the FCC Rules. Operation is subject to the following two conditions:

(1) This device may not cause harmful interference, and (2) this device must accept any interference received, including interference that may cause undesired operation.

Changes or modifications not expressly approved by the party responsible for compliance could void the user's authority to operate the equipment.

NOTE: This equipment has been tested and found to comply with the limits for a Class B digital device, pursuant to part 15 of the FCC Rules. These limits are designed to provide reasonable protection against harmful interference in a residential installation. This equipment generates, uses and can radiate radio frequency energy and, if not installed and used in accordance with the instructions, may cause harmful interference to radio communications. However, there is no guarantee that interference will not occur in a particular installation. If this equipment does cause harmful interference to radio or television reception, which can be determined by turning the equipment off and on, the user is encouraged to try to correct the interference by one or more of the following measures:

Reorient or relocate the receiving antenna, increase the separation between the equipment and receiver, and connect the equipment into an outlet on a circuit different from that to which the fan is connected.

KICHLER®

www.kichler.com

KICHLER® LIGHTING

7711 EAST PLEASANT VALLEY ROAD P.O. BOX 318010

CLEVELAND, OHIO 44131-8010

CUSTOMER SERVICE 866.558.5706

8:30 AM TO 5:00 PM EST, MONDAY - FRIDAY