

IC/Air2 and IC/Air3

Installation Instructions and Owners Manual



Please read and save these instructions.

Should you have any questions or difficulty installing your fan, **call us first!**

Customer Service
Monday-Friday, 8am - 4pm (PST)
(tel) 888.588.3267 or 541.482.8545



Net weight IC/Air2 fan: 14 lbs.
Net weight IC/Air3 fan: 15 lbs.

Safety Instructions

Please read all safety instructions prior to installing your ceiling fan and save this manual for future reference. If you are in doubt with any of the information provided, we recommend that you consult with or hire a qualified electrician to install your outlet box and ceiling fan.

If you have any questions or difficulty installing your fan, call our customer service at (888) 588-3267.



WARNING!!

To reduce the risk of fire, electrical shock, or personal injury please observe the following:

- Mount fan directly from building structure and/or an outlet box marked "Acceptable for Fan Support" of 50 lbs (22.7 kg) and use the mounting screws provided with the outlet box. **Note:** Most outlet boxes commonly used for light fixtures are not acceptable for fan support and may need to be replaced. Consult a qualified electrician if in doubt.
- Prior to installation or servicing always disconnect the power by turning off the circuit breakers to the outlet box and associated wall switch location. If you cannot lock the circuit breaker in the off position, securely fasten a prominent warning device, such as a tag, to the service panel.
- Do not bend the blade brackets when installing the brackets, balancing the blades, or cleaning the fan. Do not insert foreign objects in between rotating fan blades.
- All wiring must be in accordance with national and local electrical codes ANSI/NFPA 70. If you are unfamiliar with wiring, use a qualified electrician.
- Use this unit only in the manner intended by the manufacturer. If you have any questions contact the Modern Fan Co at (888) 588-3267.
- Use only Modern Fan Co replacement parts.

Installation Preparation



Make sure the installation site you choose allows the fan blades to rotate without obstruction. Allow a minimum clearance of 7 feet from the floor to the blades and 30 inches from the wall to the end of the blades.



Your new ceiling fan will require a grounded electrical supply line of 120 volts AC, 60 Hz, 15 amp circuit. The outlet box must be securely anchored and capable of withstanding a load of 50 lbs.

Tools Needed:

A stepladder, phillips head screwdriver and a wire stripper.

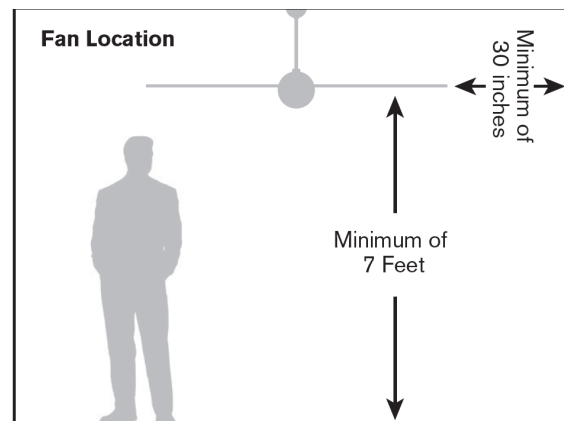

Fan Installation

- 1** Remove and identify contents of carton.

2 or 3 Blades **Bottom Cap** **Body** **Canopy**

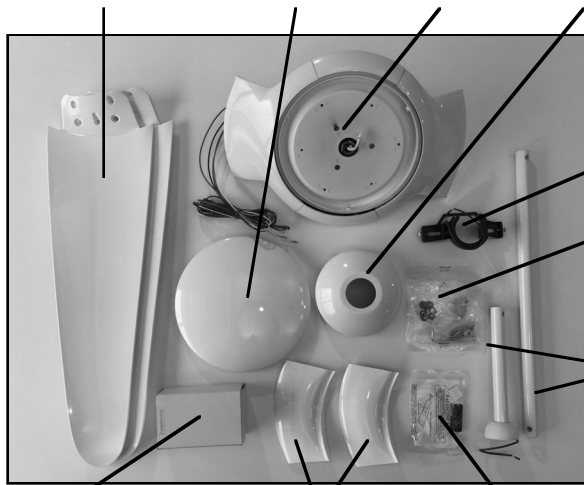

Control(s) **2 or 3 Screw Covers** **Balancing Kit**

Hanging Bracket

Hardware Pack

Down Rods

Optional Light Kit parts:

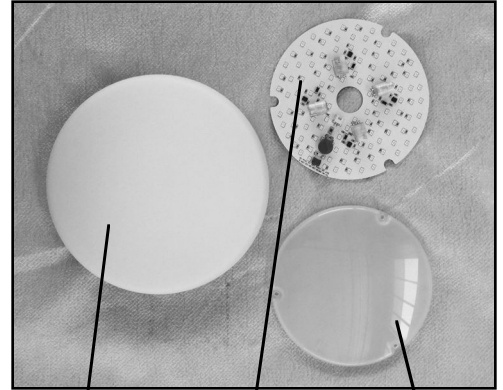

Glass Diffuser **LED Board** **LED Cover**

- 2** If your fan was ordered with the optional LED light kit, continue with Step 2 here. If your fan was not ordered with the optional light kit, proceed to step 3. Keep in mind, the optional LED can be ordered and added to your fan at a later date.

To install optional LED, carefully place fan body (bottom side up) on top of either piece of packing foam. Take care to protect wires and fan body from damage. Place LED board on light plate so that three screws are positioned in cutout notches of the LED board. Carefully insert 2-pin connector into port on LED board. If excess wire length is protruding from bottom of fan, gently pull the blue and white wires from the top side of fan to reduce length on underside of fan. Next, remove the three screws from the light plate and place plastic LED cover over LED board with holes aligned for attachment. Reinstall the same three screws from the light plate to secure the LED cover and the LED board in place.

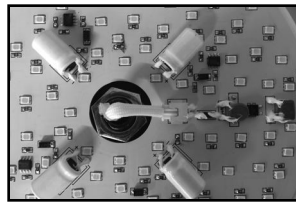
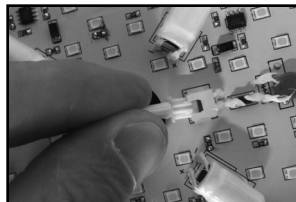
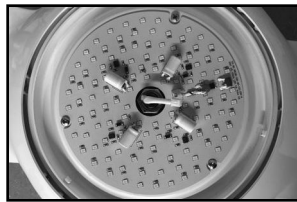

- 3** Place the fan body on either piece of the foam packaging in a manner so as to avoid damage to the light kit lead wires or the LED cover on the underside of the fan. Position a blade over a blade arm making sure that the outer edges are fitted under the blade arm spurs. While applying a bit of upward pressure on the blade tip, use the screws and rubber washers from the hardware package to secure the blade in place. Repeat for second blade (and third blade if you have a three bladed fan). Carefully position the blade screw covers over the blade arms and snap into place.

Blade arm spur

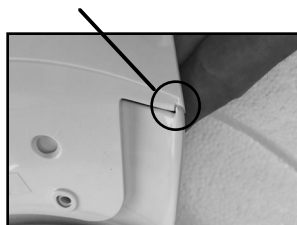

Blade screws w/ rubber washers

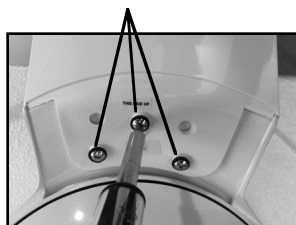

Blade screw cover

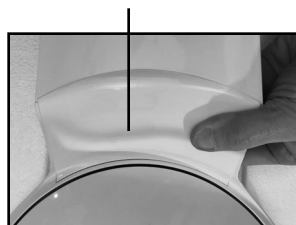

- 4** Remove down rod stopper screw from fan body and loosen collar hex screw with hex key (included in hardware pack). Remove half-ball from down rod by loosening set screw and removing stopper pin, setting aside for Step 5. Run lead wires from fan body through selected down rod and fit down rod into fan body collar, taking care not to pinch or damage wires. Align holes in down rod with hole in collar and reinstall stopper screw. Firmly tighten collar hex screw against down rod.

Note: If ceiling height allows, a longer down rod will improve air flow performance.

Remove stopper screw & loosen hex screw



Remove half-ball

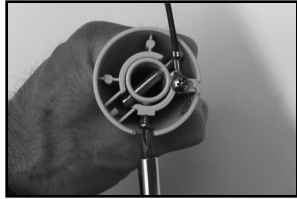

Reinstall stopper screw



Tighten collar hex screw



- 5** Run lead wires through center hole of canopy and gently set canopy on fan body. Then run lead wires through half-ball, reinstall stopper pin and tighten half-ball set screw.

Using the existing screws from your junction box, or the machine screws from the hardware package, secure the hanging bracket to the ceiling junction box. Lift fan to ceiling and set half ball in the hanging bracket so that the ridge on the edge of the hanging bracket is seated in the slotted channel in the half ball.

Canopy

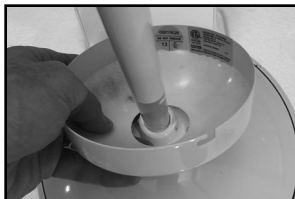

Reinstall half-ball

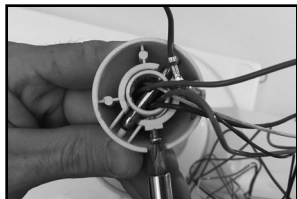

Hanging bracket



Place fan in bracket



- 6** Identify control components from control package(s). In addition to a receiving unit, your fan may have been ordered with a wall control (transmitter), a handheld remote control (transmitter) or both.



Receiving unit

Switch plate

Wall switch

Hardware & wire nuts

Batteries

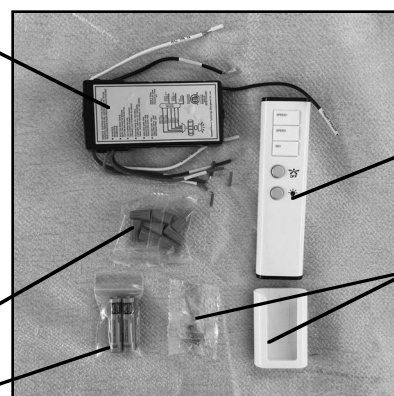

Handset

Wall Clip & hardware

Insert receiving unit into hanging bracket (between bracket arms) and make wire connections according to wire colors, labels and diagram below. If ordered, install wall switch into wall box, taking note of dip-switch settings and related instructions referenced below.



WARNING!!

Power must be disconnected at circuit breaker prior to any contact with electrical wires.

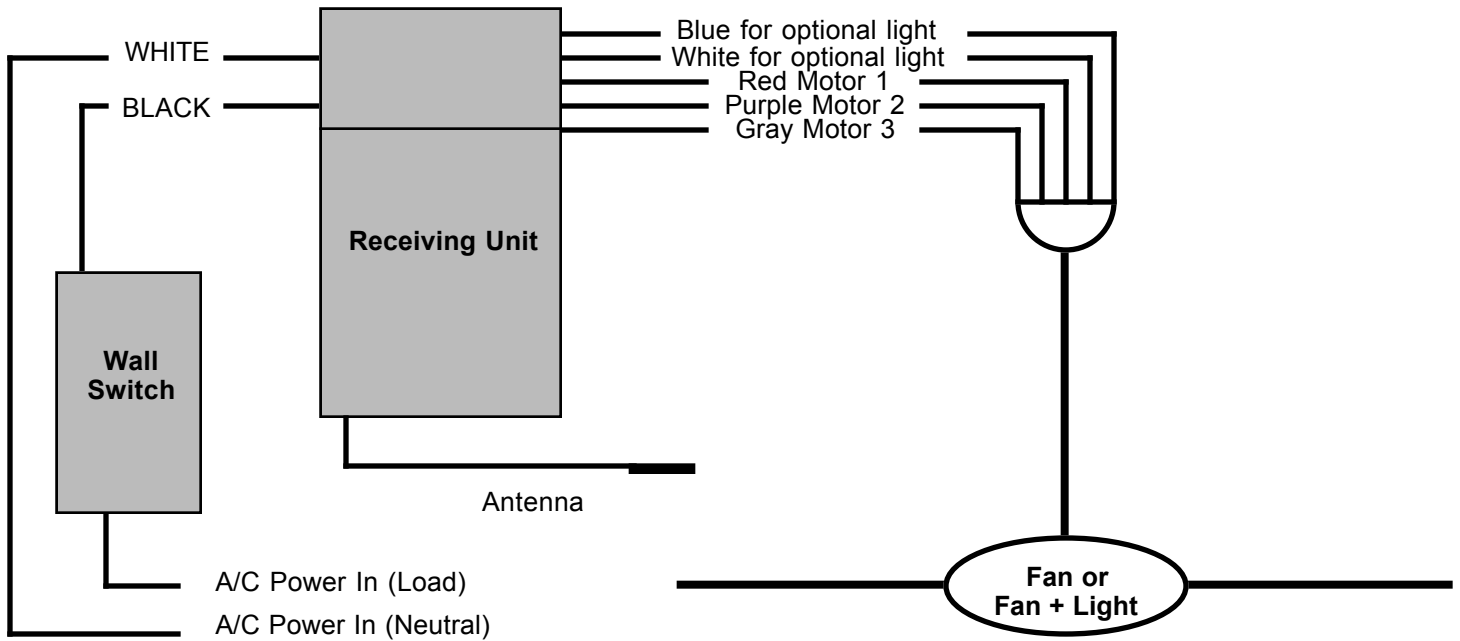

WARNING!!

Power must be disconnected at circuit breaker prior to any contact with electrical wires.

7

Your control(s) or transmitter(s) ship configured to a “Universal” or common RF channel. If you have multiple fans in close proximity, you will want to pair your wall control and/or handheld transmitters to a dedicated (or Individual) channel for each transmitter. On the wall control/transmitter, the Individual Code can be set by moving the LEFT (or upper) dip switch down (from ON to 1). On the handset, this is achieved by moving the horizontally oriented dip switch to the RIGHT (from ON to 1).

You can also select “dimming” or “on/off” light function on the wall control and/or remote handset. These transmitters ship in the “on/off” configuration. To enable dimming function on the wall transmitter, move the RIGHT (or lower) dip switch down (from ON to 2). To enable dimming function on your handset, move the vertically oriented dip switch down (from ON to 1).

Dip switches on wall switch (on left side):

Dip Switch 1- RF Code Selection
 U = Universal code for multiple fans and controls on the same channel.
 or
 I = Individual Code for isolating each fan and control to a dedicated channel.

Dip Switch 2- Light Dimming
 X = On/Off only (dimming off)
 D = Dimming on

Dip switches on handset (inside battery cover):

Dip Switch 1- RF Code Setting
 U = Universal code for multiple fans and controls on the same channel.
 or
 I = Individual Code for isolating each fan and control to a dedicated channel.

Dip Switch 2- Light Dimming
 X = On/Off only (dimming off)
 D = Dimming on

- 8 Once wire connections are completed, remove set screws on outside of hanging bracket, lift canopy up to cover receiving unit, wire connections and hanging bracket, then reinstall set screws on each side of canopy to secure in place.



- 9 Align slotted openings in bottom cap (or glass shade if optional LED is installed) with small posts on underside of fan body. Push bottom cap (or glass shade) up and gently rotate into place. There is no need to forcefully over tighten bottom cap (or glass).

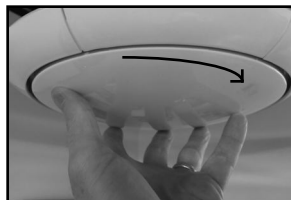

Pairing Transmitter(s)

- 10 With dip switches on the transmitter(s) set for desired function, turn power off at the bottom of your wall control or at your on/off wall switch (if using a remote handset only). Turn power back on at the breaker.

Note: If your installation does not include a switch leg, you may need a second person to execute the pairing steps described below immediately after breaker is turned on.

To pair a transmitter with the receiver, move the on/off switch on your wall control or your on/off wall switch (if using remote handset only) to the **ON** position. Immediately press and hold down the **LIGHT** and **FAN OFF** buttons (simultaneously) on your transmitter for 10-15 seconds. Your receiver can pair with two separate transmitting codes. If using a wall transmitter and a handheld transmitter with your fan, repeat pairing steps with second device. If using only one transmitter, repeat pairing steps again with your primary device. This “pushes out” the Universal code from the receiver memory and will avoid unintended interference from any nearby transmitters using the Universal channel.



Test the pairing by pressing the **SPEED+** button once. Your fan will pause and make several subtle movements prior to achieving a normal spinning motion. If fan does not respond, verify that power is on at the breaker and repeat pairing steps above. If fan does respond as expected, press the **FAN OFF** button, wait for fan to come to complete stop and then test pairing of second transmitter (if applicable).

Fan Operation

- 11 The **ON/OFF** switch on the bottom of your wall control (transmitter) terminates power to the fan. This switch must be in the “**ON**” position for your fan to receive commands and to operate. Alternatively, you may use an on/off toggle switch at the wall box in combination with a remote control handset (transmitter). In some cases, when no switch leg is present, your fan may have continuous power to the receiving unit.

Your fan has six speeds, each of which can be reached by pressing the **SPEED+** or **SPEED-** buttons on the wall control or the remote handset. The fan will always start at speed 1 (slowest) and the receiving unit will provide an audible indication (using short “chirps” and longer “beeps”) to confirm the speed you have selected as follows:

Audible fan speed indicators: 1 chirp = speed 1 (slowest)
2 chirps = speed 2
3 chirps = speed 3

1 beep = speed 4
2 beeps = speed 5
3 beeps = speed 6 (fastest)

Fan Operation... continued

The **REV** button can be used to change the direction of the fan for summer or winter operation. Allow adequate time for the fan to come to a complete stop and then restart in the opposite direction. The fan will return to the same speed at which it was operating prior to the **REV** button being used. Alternatively, you can leave your fan in the summer (downward) airflow setting and simply set it to a low speed for winter use. This method will also achieve effective destratification (recirculation) of warmer air trapped at the ceiling level.

The **LIGHT** button turns the light on and off with each contact. If the dip switch on your controller is set to “**D**” for dimming, pressing and holding the light button will achieve continuous dimming (cycling all the way down then all the way back up) until you release the **LIGHT** button. The top and bottom of the dimming range are indicated by an audible “chirp” from the receiving unit.

If you slide the **ON/OFF** switch to “**OFF**”, the fan will return to the same speed and directional setting (and light setting if an optional light is installed) when you slide the switch back to the “**ON**” position. The same memory function will exhibit if you are using an **ON/OFF** toggle switch in combination with a handheld remote control (transmitter).

It is recommended that when the fan is not in use for an extended duration, the **ON/OFF** switch on the wall control (transmitter) should be moved to the “**OFF**” position. Similarly, if you are using an **ON/OFF** toggle switch in combination with a handheld remote control (transmitter), it is recommended that the switch be turned “**OFF**” when the fan is not in use for a continuous duration.

Fan Balancing

- 12** The rotor and motor of your fan have been dynamically tested and balanced during manufacturing and production. In addition, the blades have been matched to the nearest gram to ensure well balanced operation. Furthermore, a blade balancing kit has been included with your fan. Please refer to the instructions packaged with the balancing kit should your fan require additional balancing.



709 Washington Street • Ashland, OR 97520 • (tel) 888.588.3267 • (e) info@modernfan.com

www.modernfan.com