

Installation Instructions

ONYX 6" LED RETROFIT

READ PRIOR TO ATTEMPTING INSTALLATION
ALWAYS TURN OFF MAIN POWER BEFORE INSTALLATION
INSTALLATION SHOULD BE CARRIED OUT BY YOUR LOCAL ELECTRICIAN

- ⚠ WARNING** - Risk of fire or electric shock. LED Retrofit Kit installation requires knowledge of luminaire electrical systems. If not qualified, do not attempt installation. Contact a qualified electrician.
- ⚠ WARNING** - Risk of fire or electric shock. Install this kit only in luminaires that have the construction features and dimensions shown in the photographs and / or drawings and where the input rating of the retrofit kit does not exceed the input rating of the luminaire.
- ⚠ WARNING** - To prevent wiring damage or abrasion, do not expose wiring to edges of sheet metal or other sharp objects.
- ⚠ WARNING** - Only those open holes indicated in the photographs and / or drawings may be made or altered as a result of kit installation. Do not leave other open holes in an enclosure of wiring or electrical components.
- ⚠ WARNING** - This equipment is intended to be installed only by qualified personnel. The installation must be made in accordance with the current edition to the National Electric Code and all applicable state and local building codes. The final installation must be approved by the appropriate qualified electrical/building inspector(s). Improper installation may result in a fire or electrical hazard. Be sure the electrical power to the circuit has been disconnected before installing this electrical system.
- ⚠ AVERTISSEMENT** - Risque d'incendie ou d'électrocution. L'installation du kit LED Retrofit requiert la connaissance des systèmes électriques des luminaires. Si vous n'êtes pas qualifié, ne tentez pas l'installation. Contactez un électricien qualifié.
- ⚠ AVERTISSEMENT** - Risque d'incendie ou de choc électrique. N'installez ce kit que dans des luminaires ayant les caractéristiques de construction et les dimensions indiquées sur les photographies et / ou les dessins et dont la valeur d'entrée du kit de conversion ne dépasse pas la puissance nominale du luminaire.
- ⚠ AVERTISSEMENT** - Pour éviter d'endommager le câblage ou l'abrasion, n'exposez pas le câblage aux bords de la tôle ou d'autres objets pointus.
- ⚠ AVERTISSEMENT** - Seuls les trous ouverts indiqués sur les photographies et / ou les dessins peuvent être réalisés ou modifiés à la suite de l'installation du kit. Ne laissez pas d'autres trous ouverts dans une enceinte de câblage ou de composants électriques.
- ⚠ AVERTISSEMENT** - Cet équipement est destiné à être installé uniquement par du personnel qualifié. L'installation doit être faite en conformité avec l'édition actuelle du Code national de l'électricité et toutes étatiques et locales codes du bâtiment applicables. L'installation finale doit être approuvée par l'inspecteur en électricité / bâtiment qualifié approprié(s). Une mauvaise installation peut entraîner un incendie ou un risque électrique. Soyez sûr de la puissance électrique vers le circuit a été coupée avant l'installation de ce système électrique.

THIS RETROFIT KIT IS ACCEPTED AS A COMPONENT OF A LUMINAIRE WHERE THE SUITABILITY OF THE COMBINATION SHALL BE DETERMINED BY AUTHORITIES HAVING JURISDICTION.

CE KIT DE RETROFIT EST ACCEPTÉ COMME COMPOSANT D'UN LUMINAIRE OÙ L'ADÉQUATION DE LA COMBINAISON EST DÉTERMINÉE PAR LES AUTORITÉS COMPÉTENTES.

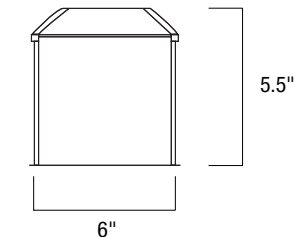
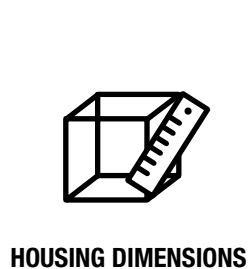
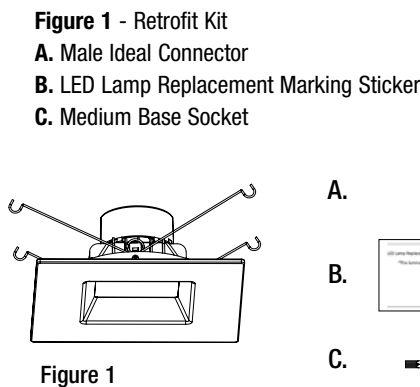

MIN. LAMP COMPARTMENT DIMENSIONS
152mm (6") (D) X 139mm (5-1/2") (H)

Safety tests was conducted in minimum housing dimension specified (Figure 2).
Luminaire malfunction and overheating may occur if installed into a smaller housing.

Figure 2

Installation Instructions

ONYX 6" LED RETROFIT

READ PRIOR TO ATTEMPTING INSTALLATION
ALWAYS TURN OFF MAIN POWER BEFORE INSTALLATION
INSTALLATION SHOULD BE CARRIED OUT BY YOUR LOCAL ELECTRICIAN

For Retrofit Housings:

1. Connect orange female to male connector of the fixture to housing. (Figure 3)
Connector is not intended to support weight of the fixture. Please support fixture at all times.
2. Squeeze in mounting blade on both side and carefully push fixture into the housing (Figure 4)
3. Squeeze tension springs together and insert into holder in housing for 6" Onyx. (Figure 5)

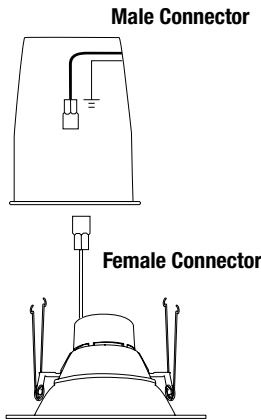

Figure 3

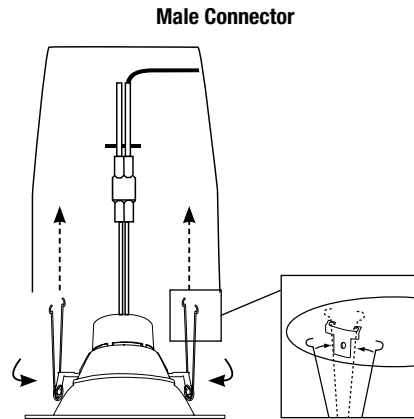

Figure 4

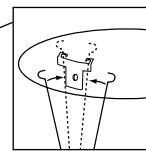
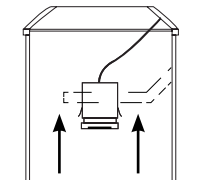

Figure 5

For Retrofit Housings:

1. Place provided LED Lamp Replacement Marking Sticker inside the housing where visible to installer.
2. Remove medium-base mounting bracket only if necessary to provide room for fixture to be installed fully and properly into the housing. (Figure 7)



Remove bracket if necessary.

Figure 7

3. Use provided medium-base socket adapter and attach each end to housing and fixture. (Figure 8)

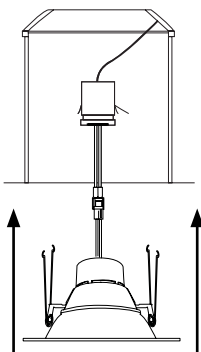

Figure 8

For Retrofit Housings (Optional):

1. Place provided LED Lamp Replacement Marking Sticker inside the housing where visible to installer.
2. Cut Medium base socket adapter (Figure A)

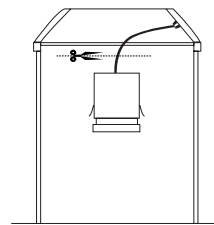

Figure A

3. Replace with provided male orange connector. (Figure B)

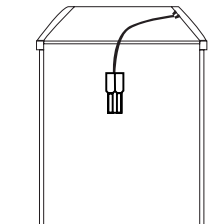

Figure B

4. Squeeze in mounting torsion springs on both sides and carefully push fixture into the housing. (Figure 5)