

T24M TUBO SMALL 2-CIRCUIT MAGNETIC TRACK HEAD

24VDC INTEGRATED LED, STATIC WHITE & WARM DIM TECHNOLOGY

REV 04.16.25



T24M-2C-TUBS-SP-30K-WH



T24M-2C-TUBS-SP-30K-BK

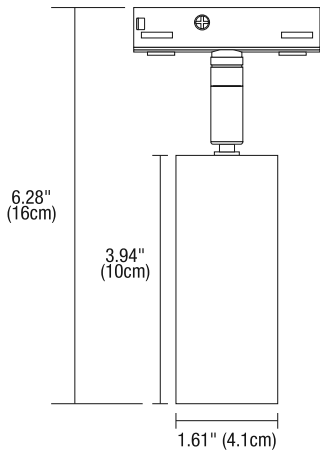

Magnetic Track Heads Easily Click Into Place



DESCRIPTION

Our 2-Circuit Magnetic Tubo Small Track Head is an 8-watt luminaire that delivers up to 485 lumens blending practical technology with minimalist aesthetics making the most out of ceiling space while exhibiting a simple, modern design. Being part of an entirely Low Voltage 24VDC system, it offers unsurpassed efficiency in comparison to traditional track lighting systems. The cylindrical flat-back design houses the heat-sink, LED module, and integrated driver offering 360° horizontal rotation and 90° vertical aiming. Available in five Color Temperatures including Warm Dim (30D), that dims from 3000K-1800K exhibiting designer-grade color rendering as high as 98 CRI and R9-90. The low voltage track connector is compatible with Magnetic TruTrack and Magnetic Surface Track. Choose from four different beam spreads as well as multiple lens accessories, including field-changeable, optic reflectors. With every element designed to be slender and unobtrusive, the Tubo Small provides superb illumination and functionality within a small package. For custom quotes and layout assistance, send your drawings and ideas to our design team: design@PureEdgeLighting.com.

MOUNTING OPTIONS

Compatible with PureEdge T24M Track Heads are Compatible with TruTrack® (TR24M-2C) and Surface Mount track (TS24M-2C).

REMOTE POWER SUPPLIES (SOLD SEPARATELY)

24VDC, Class 2 wiring

- Uni Trim Power Supply Universal Dimming (TRIAC, ELV, 0-10V)
ELV & TRIAC Smart Dimmer & Switch

DIMMING

- Compatible with Lutron Diva, Skylark and Legrand 0-10 Volt dimmers
- Dimmable to 1%, Flicker less than 2%

LAMPING

BEAM ANGLE REFERENCE 45°					
COLOR TEMPERATURE	24K	27K	30K	30D	35K
TOTAL LUMENS	503	420	434	287	515
WATTS	9	9	9	8	9
LUMENS PER WATT (lm/w)	59	49	51	39	61
CRI	97	92	93	94	98
TM-30 DATA	R9: 60 Rf: 93 Rg: 98	R9: 97 Rf: 92 Rg: 100	R9: 64 Rf: 91 Rg: 98	R9: 90 Rf: 95 Rg: 102	R9: 92 Rf: 94 Rg: 101
LAMP LIFE	60,000 Hours, 70% Lumen Maintenance				

ACCESSORIES

Additional lenses can be ordered and changed in the field offered in NS (15°), SP (25°), NF (35°), FL (45°), WF (60°) beam spread options

APPLICATIONS

Designed for indoor use only, dry and damp locations. Ideal applications in Commercial, Retail, Residential, Hospitality, Education and Healthcare Institutions.

WARRANTY / LABELS

Pro-rated 5 year warranty. Assembled in America, ETL (Conforms to UL1598 and CSA 22.2 #250.0) RoHs, JA8 listed with universal power supplies in 27K> CCT.

FINISHES

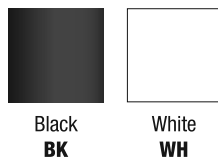

System	Type	Fixture	Beam Spread	Color Temperature	Finish
T24M	2C	TUBS	SP	30K	BK
T24M Track Head 24V Magnetic Connector	2C 2 Circuit	TUBS Tubo Small	NS Narrow Spot 15° SP Spot 25° NF Narrow Flood 35° FL Flood 45° WF Wide Flood 60° For 7° use STB16-BK snoot with NS	24K 2400K Very Warm White 27K 2700K Incandescent White 30D 3000D Warm Dim* 30K 3000K Warm White 35K 3500K Neutral White *NS with 30D Warm Dim uses snoot see accessory pages for details	BK Black Powder Coat WH White Powder Coat





PROJECT	FIXTURE TYPE	DATE
---------	--------------	------

T24M TUBO SMALL 2-CIRCUIT MAGNETIC TRACK HEAD

24VDC INTEGRATED LED, STATIC WHITE & WARM DIM TECHNOLOGY

REV 04.16.25

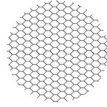
Additional Lenses and Accessories

TUBO SMALL LENS		SNOOT	LOUVER	FOCUS LENS	LINEAR SPREAD FILM	
						
ORDERING CODE	STATIC WHITE LEN-TUBS-NS-SW LEN-TUBS-SP-SW LEN-TUBS-NF-SW LEN-TUBS-FL-SW LEN-TUBS-WF-SW	WARM DIM LEN-TUBS-NS-WD LEN-TUBS-SP-WD LEN-TUBS-NF-WD LEN-TUBS-FL-WD LEN-TUBS-WF-WD	TUBS-ST-BK TUBS-ST-WH (WHITE SHELL)	L016-H	LF-TUBS-SF (SOFT FOCUS), MF (MEDIUM FOCUS), WF (WHITE FOCUS)	LF-TUBS-LS
LENS SIZE	1.375" (35mm) Diameter					
BEAM SPREADS	NS (15°), SP (25°), NF (35°), FL (45°), WF (60°)		Conical snoot creates a 7° Beam spread and is designed to reduce spill and control glare. Spun aluminum.	Hexcell louver eliminates glare. 0.125" Thickness.	Soft focus lens is included with every track head. Diffuses the beam, providing uniform illumination.	Linear spread film: directs the light into an elongated beam. Typical applications using 10°, 15°, 25° include illuminating landscape oriented art. 35°, 40°, 60° create an elongated oval typically used for wall washing.

TUBO SMALL NARROW SPOT (NS) 30D WARM DIM WITH SNOOT DETAIL

WARM DIM: 8 WATTS

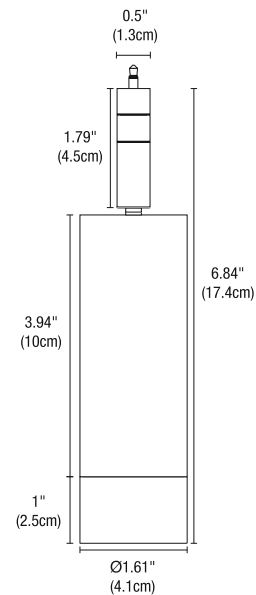

*Snoot is included in ordering code & required for use

TUBO SMALL Photometric Data at 3000K

D - Distance from fixture FC - Initial foot candles at the center of beam DIA - Diameter

NARROW SPOT BEAM ANGLE 15°

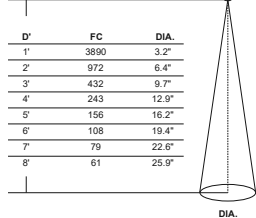

SPOT BEAM ANGLE 25°

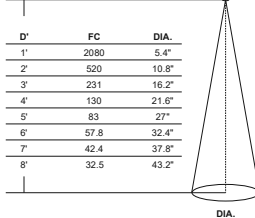

NARROW FLOOD BEAM ANGLE 35°

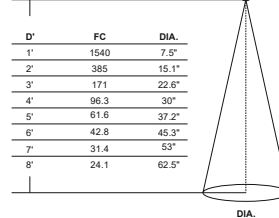

FLOOD BEAM ANGLE 45°

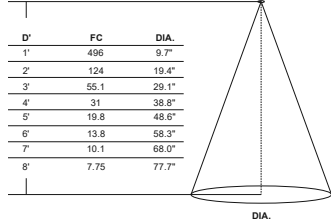

WIDE FLOOD BEAM ANGLE 60°

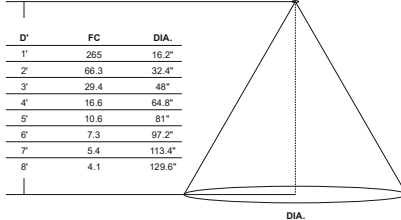

PROJECT	FIXTURE TYPE	DATE
---------	--------------	------

UNIVERSAL POWER SUPPLIES WITH TRIM

24VDC, UNIVERSAL DIMMING (ELV, TRIAC, 0-10V) STATIC WHITE & WARM DIM FOR TRACK HEADS

REV 04.16.25



DESCRIPTION

The Uni TRIM Power Supply is designed for 24 Volt Track Heads, accepts input voltage in a range of 120 - 277VAC and outputs 24VDC power up to 96 watts. Can be used as a dimmable or non-dim Power Supply. Dims down 7% with an ELV dimmer or a 0-10 volt dimmer when two additional wires are connected to the dimmer. The enclosure provides a space inside for electrical connections. Power Supply features short circuit and overload and over temperature protection. Indoor applications only. For custom quotes and layout assistance, send your drawings and ideas to our design team: design@PureEdgeLighting.com.

MOUNTING

Surface mounted with conduit access

COMPATIBILITY

Compatible with PureEdge 24VDC Track heads (T24, T24M), Vanishing Point and Mono-point/Multi-point heads (FJ24, VR, V2MR, MR2R, M44R, 2RRE, 3R8R).

POWER INPUT

120-277 volts AC, 50/60Hz

POWER OUTPUT

Class 2; 24 volts DC 4A, 96 watts maximum

EFFICIENCY

85%

AMBIENT OPERATING TEMPERATURE

-25C to 40C

ELV DIMMER TYPE

Legrand: Adorne ADTP703TU
Lutron: Diva DVELV-300P, Skylark SELV-300P, Maestro MAELV-600 and Radio RA 2

MAKE IT SMART

ELV & TRIAC [Smart Dimmer & Switch](#)

0-10 DIMMER TYPE

Lutron: Radio RA2 (with GRX-TVI), Grafik Eye Qs (with GRX-TVI), Diva (with PP20); Nova T
Philips: Sunrise SR1200ZTUNV
Leviton: IP710-DL

DIMMING CURVE

Linear, Logarithmic 100% - 7% (HydraDrive)

APPLICATIONS: Indoor

To avoid overheating the power supply, install it in a ventilated remote location where air flows. Maintain proper spacing among power supplies when multiple power supplies are installed in the same remote location.



Product	Wattage	Dimming	Voltage	Type	Options
PSB	96W	UNI	24VDC	T	STANDARD (Leave Blank)
PSB Power Supply with Enclosure Box	40W 40 Watt 60W 60 Watt 96W 96 Watt 2X40W 2x40 Watt 2X60W 2x60 Watt 2X96W 2x96 Watt	UNI Universal Power Supply	24VDC 24 Volt DC	T Trim	TB T-Bar CP Chicago Plenum

PROJECT		FIXTURE TYPE		DATE	
---------	--	--------------	--	------	--



UNIVERSAL POWER SUPPLIES WITH TRIM

24VDC, UNIVERSAL DIMMING (ELV, TRIAC, 0-10V) STATIC WHITE & WARM DIM FOR TRACK HEADS

UNIVERSAL POWER SUPPLIES & RECOMMENDED DIMMERS

	PSB-40W-UNI-24VDC-T	PSB-60W-UNI-24VDC-T	PSB-96W-UNI-24VDC-T
ORDERING CODE			
SPECIFICATIONS			
MAXIMUM LOAD	40W	60W	96W
INPUT VOLTAGE	120-277VAC	120-277VAC	120-277VAC
OUTPUT VOLTAGE	24VDC	24VDC	24VDC
DIMENSIONS	15.65" X 6.37" X 3.43"	15.65" X 6.37" X 3.43"	15.65" X 6.37" X 3.43"
CLASSIFICATION	CLASS 2	CLASS 2	CLASS 2
T-BAR MOUNTING	PSB-40W-UNI-24VDC-T-TB	PSB-60W-UNI-24VDC-T-TB	PSB-96W-UNI-24VDC-T-TB
T-BAR CHICAGO PLENUM	PSB-40W-UNI-24VDC-T-CP	PSB-60W-UNI-24VDC-T-CP	PSB-96W-UNI-24VDC-T-CP

UNIVERSAL POWER SUPPLIES & RECOMMENDED DIMMERS

	PSB-2X40W-UNI-24VDC-T	PSB-2X60W-UNI-24VDC-T	PSB-2X96W-UNI-24VDC-T
ORDERING CODE			
SPECIFICATIONS			
MAXIMUM LOAD	2X40W	2X60W	2X96W
INPUT VOLTAGE	120-277VAC	120-277VAC	120-277VAC
OUTPUT VOLTAGE	24VDC	24VDC	24VDC
DIMENSIONS	15.4" X 9.73" X 3.43"	15.4" X 9.73" X 3.43"	15.4" X 9.73" X 3.43"
CLASSIFICATION	CLASS 2	CLASS 2	CLASS 2
T-BAR MOUNTING	PSB-2X40W-UNI-24VDC-T-TB	PSB-2X60W-UNI-24VDC-T-TB	PSB-2X96W-UNI-24VDC-T-TB
T-BAR CHICAGO PLENUM	PSB-2X40W-UNI-24VDC-T-CP	PSB-2X60W-UNI-24VDC-T-CP	PSB-2X96W-UNI-24VDC-T-CP

ELV DIMMING & CONTROLS

LUTRON DIVA: DVELV-300P	•	•	•
LUTRON SKYLARK: SELV-300P	•	•	•
LUTRON RADIO RA3: RR-PROC3-XX	•	•	•
LUTRON MAESTRO: MAELV-600	•	•	•
LEGRAND ADORNE: ADTP-703TUM4	•	•	•

0-10 DIMMING & CONTROLS

PHILIPS SUNRISE: SR1200ZTUNV	•	•	•
LUTRON DIVA: DVTW-WH, DVSTV-WH	•	•	•
LUTRON NOVA T: NTSTV-DV-XX	•	•	•
LUTRON GRAFIX EYE QS: QSGRJ-XP	•	•	•
LUTRON RADIO RA3: RR-PROC3-XX	•	•	•
LEVITON: LEV40050	•	•	•
LEVITON IP710-LFZ	•	•	•
LEGRAND: ADPD4FBL3P2W4	•	•	•
LEGRAND RADIANT: RH703PTUW	•	•	•

TRIAC DIMMING & CONTROLS

LUTRON SKYLARK: S2-L-WH	•	•	•
LUTRON DIVA DVLV-600P-WH	•	•	•
LUTRON DIVA DVLV-603P-WH	•	•	•
LUTRON MAESTRO MALV-600-WH	•	•	•
LUTRON MAESTRO MALV-1000-WH	•	•	•
LUTRON MAESTRO MA-R-XX	•	•	•
PURE SMART DIMMER AND SWITCH	•	•	•

- Flicker free dimming
- Aluminum casing for optimal heat dissipation
- Isolated output power per e and UL safety requirements
- UL & ETL recognized/ listed, meets UL 8750, 1310 requirements
- Auto-reset; short circuit, overload and thermal protection
- Class 2 power supply
- Efficient, High power factor > 0.90

- The Solid State Constant Voltage Uni-Power Supply is compatible with most commercially available Dimmers:
 - Triac Dimmer: (Forward Phase) Typically used for the dimming of Incandescent and Low Voltage Magnetic Transformers
 - ELV Dimmer: (Reverse Phase) Dimming of Electronic Low Voltage Transformers and Power Supplies used for LED lighting
 - 0-10 Dimmer : Dims the Low Voltage side of a 0-10 volt power supply commonly used in large scale lighting or commercial applications.
- The Uni-Power Supply is recommended with any Siemens/Murray brand of arc fault breaker to overcome the issues with tripping the breakers with ELV Low Voltage Drivers.

*Title 24 with JA8 listed PureEdge products and systems

PROJECT	FIXTURE TYPE	DATE
---------	--------------	------

UNIVERSAL POWER SUPPLIES WITH TRIM

24VDC, UNIVERSAL DIMMING (ELV, TRIAC, 0-10V) STATIC WHITE & WARM DIM FOR TRACK HEADS

POWER SUPPLY DIMENSIONS & DIAGRAMS

40W, 60W, 96W

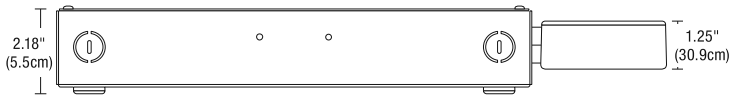
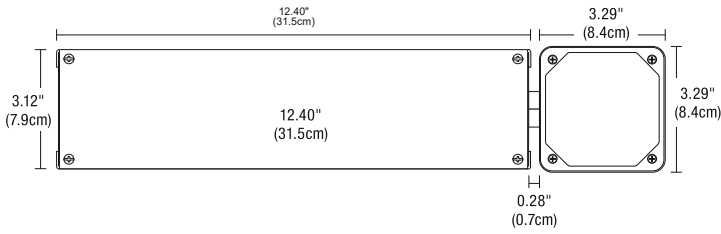

2X40W, 2X60W, 2X96W

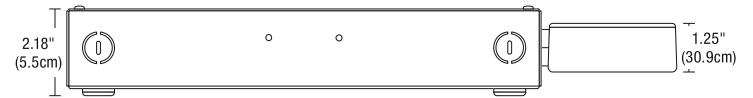
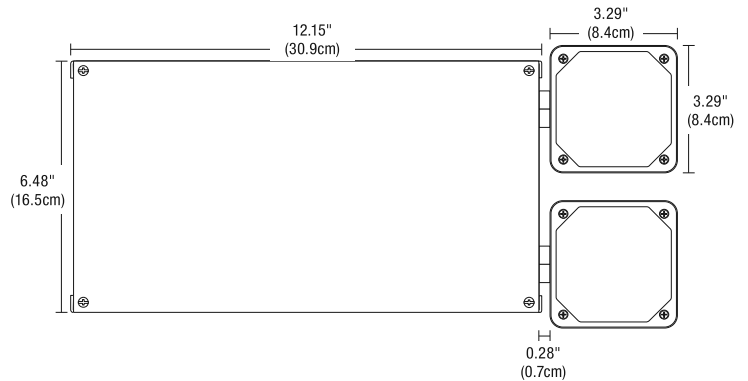

T-BAR GRID CEILING

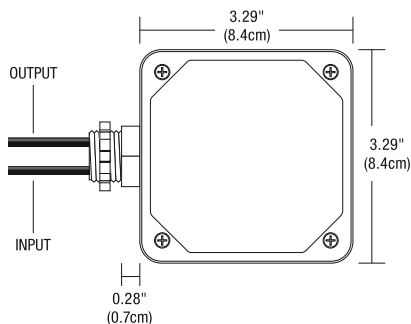
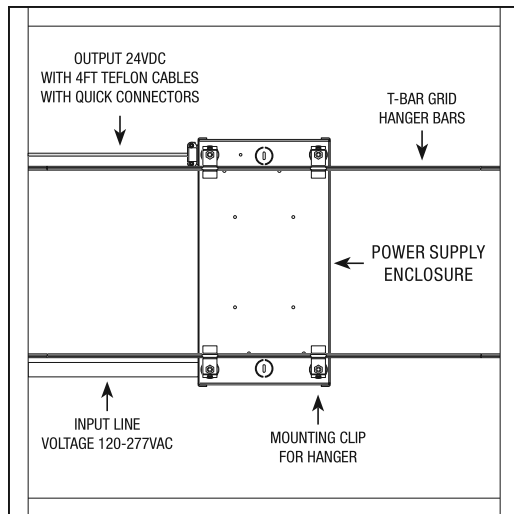

VOLTAGE TRIM BOX

Voltage Trim Box is included with power supply. Mounts in 1/2" knock-outs. The part number below is to be used for replacement only.

Product	Voltage	Type
PSB	24VDC	TRIM
PSB Power Supply with Enclosure Box	24VDC 24 Volt DC	TRIM Voltage Trim Box

PROJECT	FIXTURE TYPE	DATE
---------	--------------	------

UNIVERSAL POWER SUPPLIES WITH TRIM

24VDC, UNIVERSAL DIMMING (ELV, TRIAC, 0-10V) STATIC WHITE & WARM DIM FOR TRACK HEADS

REV 04.16.25

ELV WIRING DIAGRAM

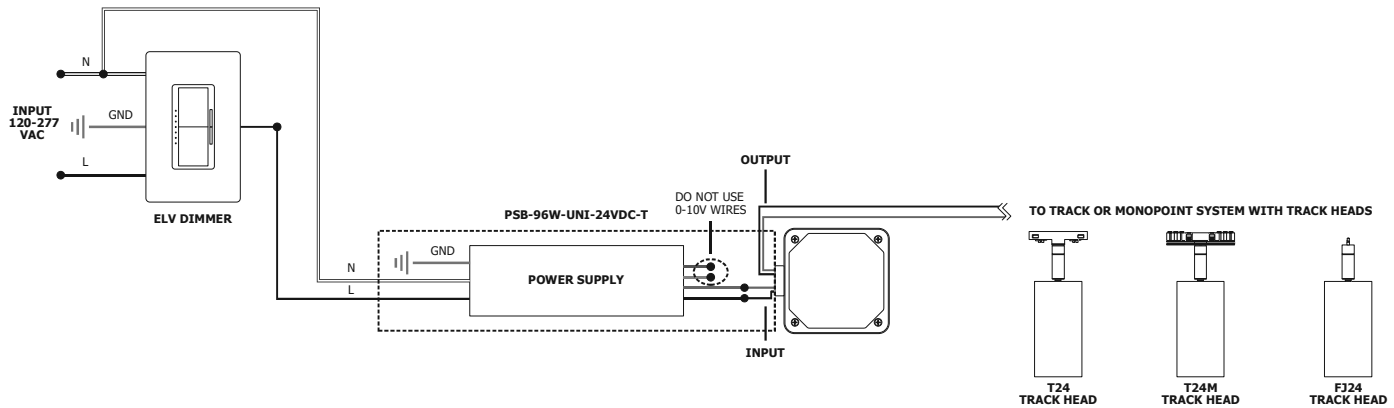

0-10V WIRING DIAGRAM

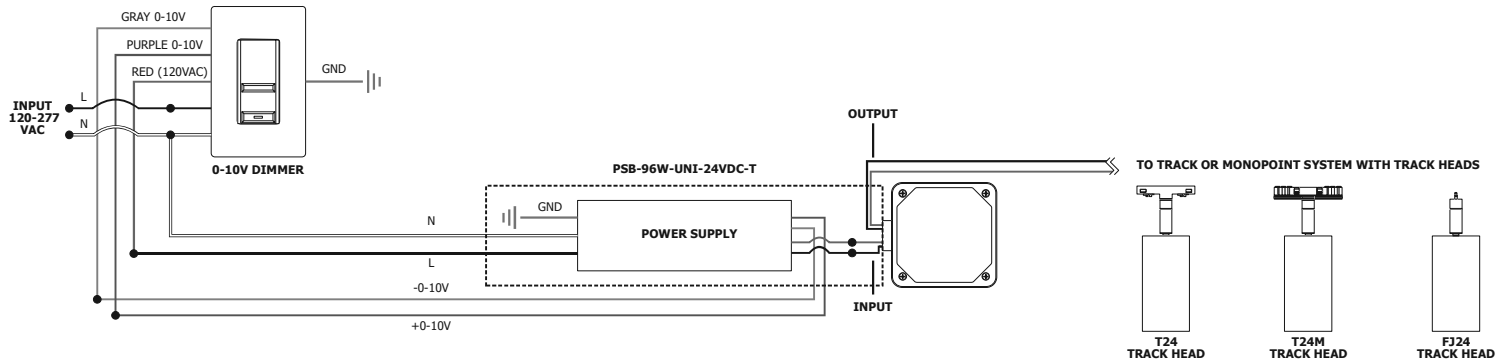

SMART WIRING DIAGRAM & NETWORK TOPOGRAPHY

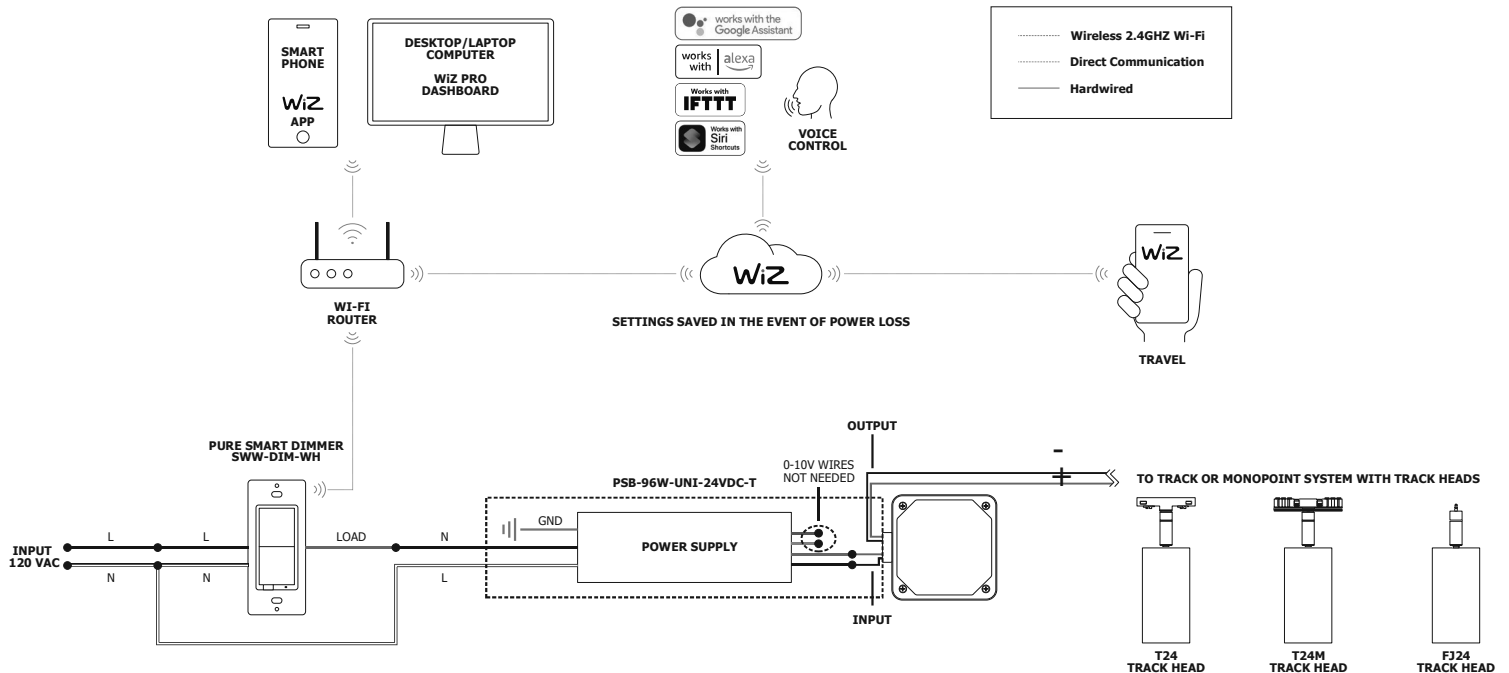

PROJECT		FIXTURE TYPE		DATE	
---------	--	--------------	--	------	--

T24 TM30 DATA

24VDC INTEGRATED LED, STATIC WHITE & WARM DIM TECHNOLOGY

TM-30 DATA: The data below is for Tubo Small. Consistent color temperatures among multiple track heads is possible through a 3 phase binning process in which each order is inspected with a color meter to ensure uniformity.

2400K | Rf: 91.2 | Rg: 96.8

Color Vector Graphic

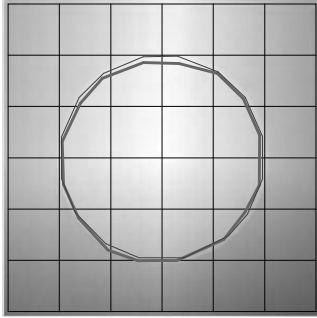

■ Test ■ Reference

HUE BIN	Rf	GRAPHIC SHIFTS %	
		CHROMA	HUE
1	92.0	-2.4%	1.5%
2	94.7	-2.1%	0.0%
3	95.4	-1.9%	-0.1%
4	88.7	-6.7%	-3.1%
5	92.8	-5.6%	1.0%
6	92.7	-3.4%	3.4%
7	89.9	-4.3%	4.1%
8	92.4	-1.4%	4.4%
9	89.0	-0.6%	5.8%
10	88.9	0.4%	6.2%
11	89.7	4.0%	5.4%
12	92.6	3.0%	-0.7%
13	90.9	1.1%	-7.0%
14	89.9	0.5%	-5.8%
15	92.1	-3.2%	0.1%
16	88.9	-1.7%	-6.3%

2700K | Rf: 87.7 | Rg: 96.1

Color Vector Graphic

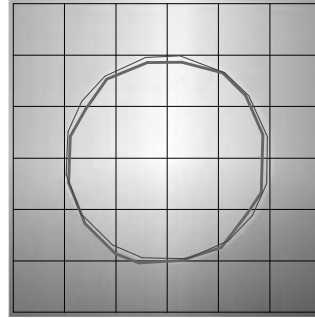

■ Test ■ Reference

HUE BIN	Rf	GRAPHIC SHIFTS %	
		CHROMA	HUE
1	88.0	-4.3%	2.6%
2	91.6	-2.4%	2.0%
3	93.7	-1.4%	1.9%
4	88.9	-5.6%	-3.1%
5	92.3	-5.5%	-0.5%
6	92.9	-3.5%	0.1%
7	84.5	-7.5%	4.6%
8	90.8	-3.0%	4.4%
9	84.5	-1.3%	8.3%
10	83.9	2.0%	9.8%
11	87.2	5.3%	7.1%
12	89.2	5.4%	-2.6%
13	88.7	0.3%	-7.8%
14	86.8	1.7%	-9.3%
15	87.6	-5.4%	-1.3%
16	83.6	-3.3%	-9.5%

3000K | Rf: 88.1 | Rg: 99.7

Color Vector Graphic

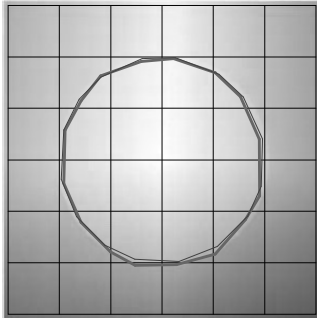

■ Test ■ Reference

HUE BIN	Rf	GRAPHIC SHIFTS %	
		CHROMA	HUE
1	92.5	-3.1%	0.3%
2	93.3	-2.3%	1.9%
3	90.9	-0.8%	3.9%
4	94.3	-1.1%	1.4%
5	92.5	-2.6%	1.5%
6	96.4	1.2%	-0.3%
7	92.6	-2.5%	-0.0%
8	96.9	-1.4%	0.2%
9	92.3	-1.8%	4.3%
10	86.6	-0.7%	7.0%
11	86.5	2.4%	8.2%
12	89.8	5.9%	1.7%
13	93.9	2.6%	-2.7%
14	89.4	5.1%	-5.8%
15	90.1	-0.1%	-4.7%
16	86.5	0.3%	-9.7%

3500K | Rf: 86.1 | Rg: 95.5

Color Vector Graphic

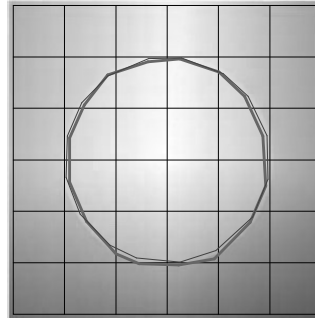

■ Test ■ Reference

HUE BIN	Rf	GRAPHIC SHIFTS %	
		CHROMA	HUE
1	90.8	-3.8%	0.3%
2	92.3	-2.8%	2.1%
3	89.7	-1.0%	4.3%
4	92.6	-1.4%	1.7%
5	91.8	-3.1%	1.3%
6	96.2	0.8%	-0.4%
7	92.9	-3.2%	0.2%
8	94.3	-2.5%	1.5%
9	90.4	-2.5%	5.2%
10	84.3	-1.4%	9.5%
11	83.1	3.5%	9.8%
12	88.2	4.8%	3.4%
13	94.0	2.7%	-2.0%
14	88.7	5.9%	-5.8%
15	88.7	0.7%	-5.9%
16	86.8	-0.7%	-6.7%

3000D | Rf: 89.8 | Rg: 101.4

Color Vector Graphic

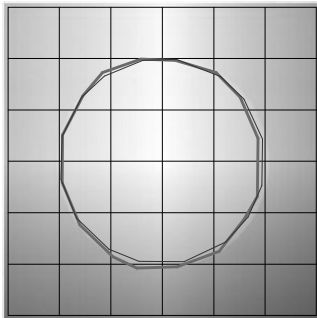

■ Test ■ Reference

HUE BIN	Rf	GRAPHIC SHIFTS %	
		CHROMA	HUE
1	90.2	-4.2%	1.5%
2	90.9	-2.0%	3.7%
3	87.9	0.8%	5.5%
4	92.1	-0.9%	0.6%
5	93.0	1.5%	1.6%
6	92.2	3.9%	-0.2%
7	92.1	-0.3%	-2.0%
8	96.7	0.0%	-1.2%
9	92.5	-0.6%	3.7%
10	88.3	1.1%	7.0%
11	87.2	4.1%	7.4%
12	87.2	6.7%	-1.0%
13	88.2	3.8%	-7.2%
14	85.3	4.3%	-9.9%
15	90.9	-2.2%	-3.6%
16	83.4	-2.2%	-11.2%

PROJECT	FIXTURE TYPE	DATE
---------	--------------	------