

TRULINE .5A STATIC WHITE

24VDC, 5/8" DRYWALL PLASTER-IN LED SYSTEM

DESIGNED BY GREGORY KAY | ASSEMBLED IN AMERICA

REV 10.16.23

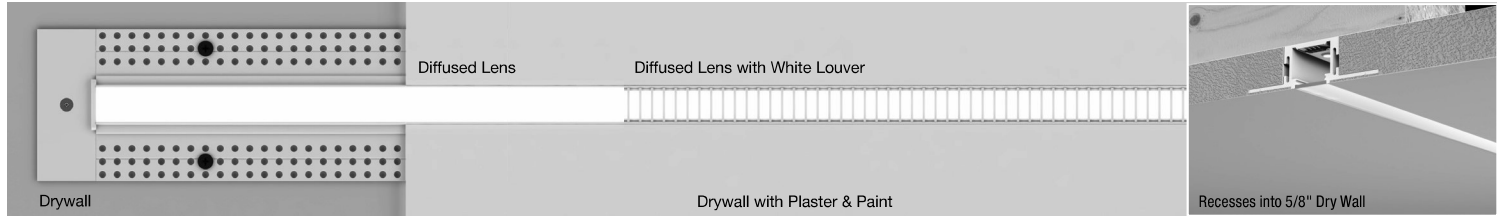

DESCRIPTION

PureEdge pioneered the TruLine .5A Plaster-in 24VDC LED system that Recesses within 5/8" drywall, without any joist modification. Redefining the relationship between Lighting and Interior Design, this Innovative and highly Efficient system blends seamlessly into the drywall, becoming part of the Architecture. The slim extrusions, LED strips, and lenses are field-cuttable and ordered in 1' increments (up to 40' before re-feeding). Multiple runs of channel mount flawlessly together providing smooth and Glare-free general illumination using Designer-grade Color Rendering LEDs (95+ CRI). With the ability to run in vertical, horizontal, and diagonal directions, the compositions are truly endless. The TruLine .5A Plaster-in LED System is offered in multiple wattage and color temperatures ranging from **2400K** through **4000K**. Click here for all [Other Color Temperatures](#). Coordinate installation with electrical and drywall contractors. Includes a 5-year pro-rated warranty. For custom designs and quotes, send drawings to design@PureEdgeLighting.com.

DESIGN NOTE

TruLine .5A can be installed on a single surface, join runs on multiple planes from wall to ceiling, or from one wall to an adjacent wall. Use TruLine .5A Build-It-Yourself (BIY) with pre-formed components to create desired configurations, including Mitered Picture Frame and Outside or Inside Corners for Room Wrapping installations. Create square or rectangular compositions with TruQuad .5A.

ORDERING & INSTALLATION

TruLine .5A can be secured to studs spaced 13"-24" apart or between studs with provided mounting straps. Requires Remote Power Supply (ordered separately) In-Wall Mounting Kits are available for select power supplies. Order in 1' increments, field-cuttable to any length.

MAXIMUM LENGTHS BEFORE RE-FEEDING

- 2WDC, 2.5 watts per foot - 40'
- 5WDC, 4.4 watts per foot - 20'
- 7WDC, 7.5 watts per foot - 12'

PureEdge is the Original Designer of 5/8" Drywall Lighting Products with the Most Experience in the industry.

LAMP

- Offered in multiple Static White Color Temperatures: 2400K, 2700K, 3000K, 3500K & 4000K
- Lumen Performance: 356lm/ft at 3000K 7W per foot
- Designer Grade High CRI 95+ LEDs
- Average life: 50,000 hours
- For additional color temperatures refer to other specifications

REMOTE POWER SUPPLIES*, DIMMERS & CONTROLS (SOLD SEPARATELY)

24VDC, Class 2 wiring

- [Pure Smart™ WiZ Pro Power Supplies & Controls](#)
- [UNI Driver: Universal Dimming \(TRIAC, ELV, 0-10V\)](#)
- [Lutron Hi-Lume/Ecosystem](#)

*In-Wall Mounting and drop ceiling Kits available for select power supplies

APPLICATIONS

Designed for any Indoor space with drywall, including Damp locations. Ideal applications in Residential, Commercial, Retail, and Hospitality environments.

COMPLIANCE

*Title 24 JA8 listed for 2700K CCT and above when used with PureEdge remote Universal power supplies, ETL, Class 2, Damp Location, Made in USA.

For quick & easy reference, plus the most up-to-date pricing, use our [TruLine .5A Configurator](#)

System	Watts Per Foot	Length in Feet	Color Temperature
TL.5A	5WDC	20FT	ST27K
TL.5A TruLine .5A	2WDC 2.5 Watts (40ft Max)	1-40FT	ST24K 2400K Very Warm White
TL.5ADW TruLine .5A with White Louver	5WDC 5 Watts (20ft Max)	1-20FT	ST27K 2700K Incandescent White
	7WDC 7.5 Watts (12ft Max)	1-12FT	ST30K 3000K Warm White
			ST35K 3500K Neutral White
			ST40K 4000K Cool White

DELIVERED LUMENS

WATTS PER FOOT	STATIC WHITE														
	2.5W					4.4W					7.5W				
COLOR TEMPERATURE	24K	27K	30K	35K	40K	24K	27K	30K	35K	40K	24K	27K	30K	35K	40K
LUMENS PER FOOT (lm/ft)	178	180	188	216	227	330	333	347	398	420	509	515	536	615	649
LUMENS PER WATT (lm/w)	71	72	75	86	91	75	76	79	91	96	70	70	73	84	89
CRI	92+	92+	92+	92+	92+	92+	92+	92+	92+	92+	92+	92+	92+	92+	92+

To determine the necessary wire gauge use our [Voltage Drop Calculator](#)

PROJECT		FIXTURE TYPE		DATE	
---------	--	--------------	--	------	--

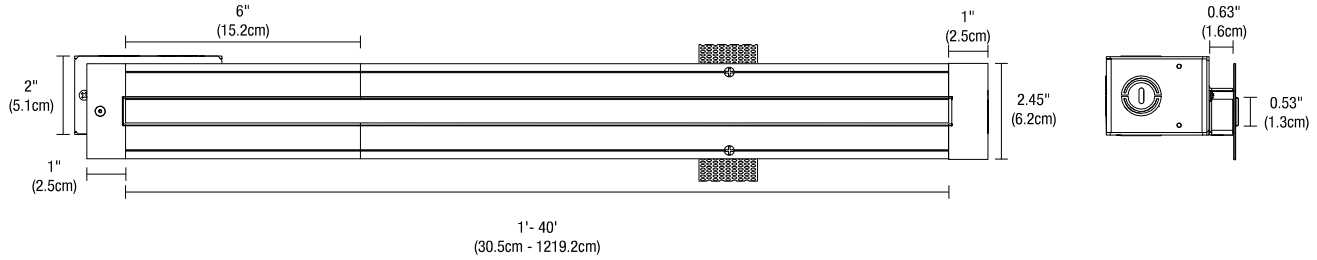

INCLUDED COMPONENTS

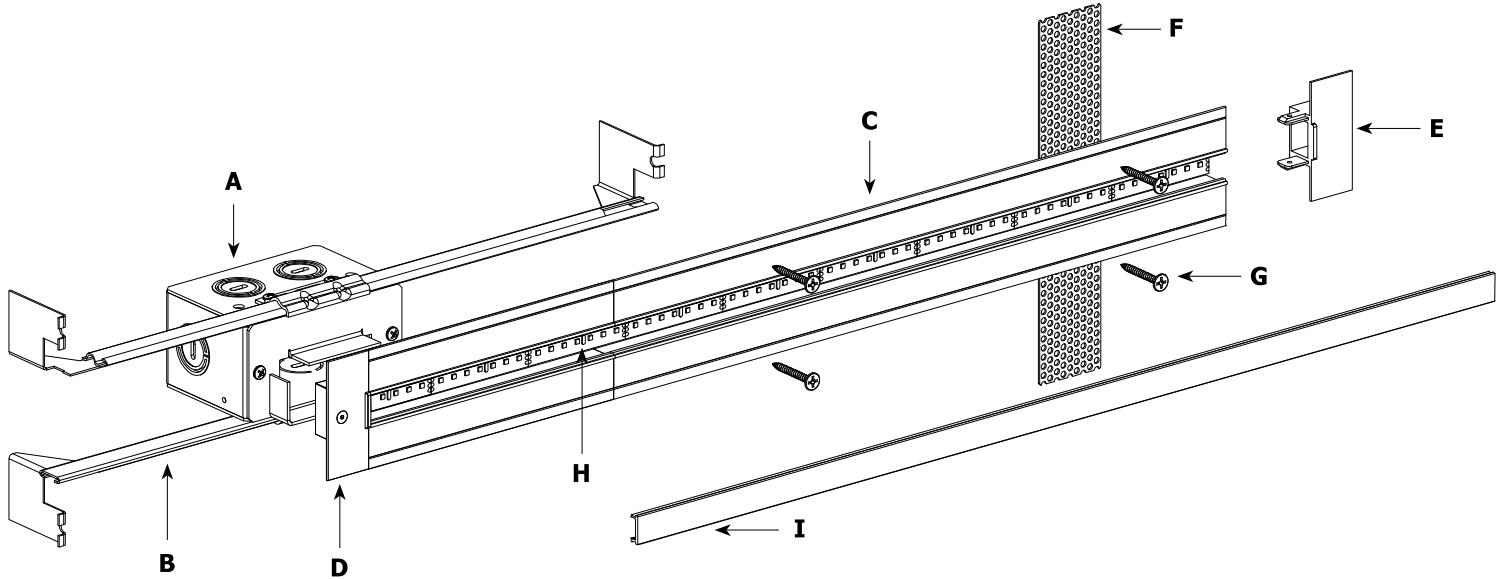

A. JUNCTION BOX

Mounts behind drywall with Adjustable Mounting Bars. Low Voltage 24VDC wires from Remote Power Supply connect to LED wires inside box. Junction Box opening is covered by channel. Required at the beginning of each run and necessary to rough-in electrical before TruLine installation. Junction Box is also included with each TruLine channel order

B. ADJUSTABLE MOUNTING BARS

Provide flexibility for mounting in a variety of spaces and orientations. May be secured to studs that are spaced 13"-24" apart.

C. TRULINE .5A CHANNEL

5/8" deep extrusion houses single row of LED Strip.

D. POWER END CAP

Provides a finished look and prevents light leak at the feed-end of a run where LED Strip enters channel.

E. TAKE-UP BOX

Prevents dark spots at the end of a run by tucking excess LED Strip safely behind the wall.

F. MOUNTING STRAP

Secures channel to drywall when wall stud is unavailable.

G. DRYWALL SCREW

Secures channel to drywall and stud.

H. LED STRIP

Your selection of LED Strip.

I. LENS

0.5" wide diffused white lens projects a clean line of light without LED pixelation.

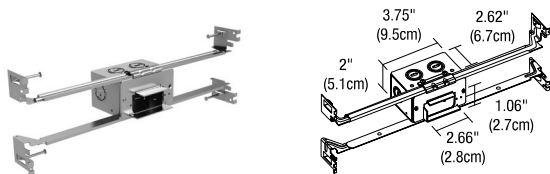

JUNCTION BOX ROUGH-IN COMPONENT

One Junction Box is included with TruLine .5A. Order additional Junction Box separately to rough-in electrical wiring before drywall installation. Quick shipment available.

System	Size	Component
TL.5A	1RE	JBOX
TL.5A TruLine .5A	1RE 1" Rectangle	JBOX Junction Box

PROJECT	FIXTURE TYPE	DATE
---------	--------------	------

LED STRIP TM30 DATA

24VDC, STATIC WHITE, WARM DIM & DYNAMIC/TUNABLE WHITE

TM-30-15 DATA: The data below is for bare LED Static White Strip. Consistent color temperatures throughout a single strip and among multiple strips is possible through a 3 phase binning process in which each order is inspected with a color meter to ensure uniformity.

2400K | Rf: 84.5 | Rg: 94.4

Color Vector Graphic

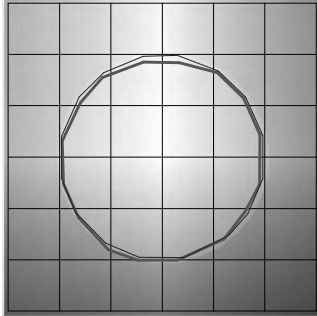

■ Test ■ Reference

HUE BIN	Rf	GRAPHIC SHIFTS %	
		CHROMA	HUE
1	92	-2.4%	1.5%
2	94.7	-2.1%	-0.0%
3	95.4	-1.9%	-0.1%
4	88.7	-6.7%	-3.1%
5	92.8	-5.6%	1.0%
6	92.7	-3.4%	3.4%
7	89.9	-4.3%	4.1%
8	92.4	-1.4%	4.4%
9	89	-0.6%	5.8%
10	88.9	0.4%	6.2%
11	89.7	4.0%	5.4%
12	92.6	3.0%	-0.7%
13	90.9	1.1%	-7.0%
14	89.9	0.5%	-5.8%
15	92.1	-3.2%	0.1%
16	88.9	-1.7%	-6.3%

2700K | Rf: 87.7 | Rg: 96.1

Color Vector Graphic

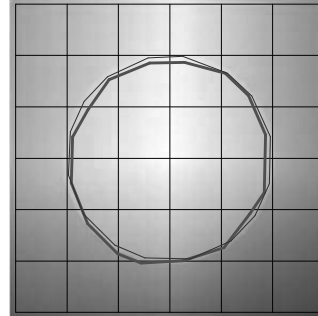

■ Test ■ Reference

HUE BIN	Rf	GRAPHIC SHIFTS %	
		CHROMA	HUE
1	88.0	-4.3%	2.6%
2	91.6	-2.4%	2.0%
3	93.7	-1.4%	1.9%
4	88.9	-5.6%	-3.1%
5	92.3	-5.5%	-0.5%
6	92.9	-3.5%	0.1%
7	84.5	-7.5%	4.6%
8	90.8	-3.0%	4.4%
9	84.5	-1.3%	8.3%
10	83.9	2.0%	9.8%
11	87.2	5.3%	7.1%
12	89.2	5.4%	-2.6%
13	88.7	0.3%	-7.8%
14	86.8	1.7%	-9.3%
15	87.6	-5.4%	-1.3%
16	83.6	-3.3%	-9.5%

3000K | Rf: 88.1 | Rg: 99.7

Color Vector Graphic

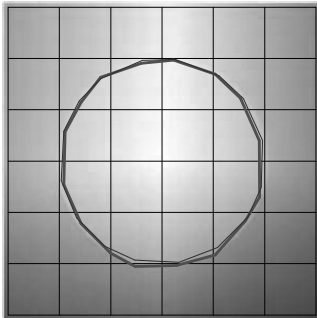

■ Test ■ Reference

HUE BIN	Rf	GRAPHIC SHIFTS %	
		CHROMA	HUE
1	92.5	-3.1%	0.3%
2	93.3	-2.3%	1.9%
3	90.9	-0.8%	3.9%
4	94.3	-1.1%	1.4%
5	92.5	-2.6%	1.5%
6	96.4	1.2%	-0.3%
7	92.6	-2.5%	-0.0%
8	96.9	-1.4%	0.2%
9	92.3	-1.8%	4.3%
10	86.6	-0.7%	7.0%
11	86.5	2.4%	8.2%
12	89.8	5.9%	1.7%
13	93.9	2.6%	-2.7%
14	89.4	5.1%	-5.8%
15	90.1	-0.1%	-4.7%
16	86.5	0.3%	-9.7%

3500K | Rf: 86.1 | Rg: 95.5

Color Vector Graphic

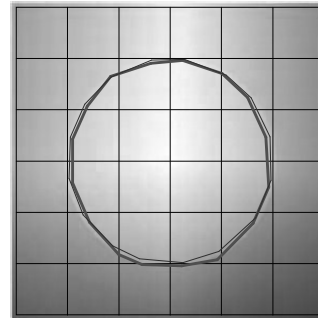

■ Test ■ Reference

HUE BIN	Rf	GRAPHIC SHIFTS %	
		CHROMA	HUE
1	90.8	-3.8%	0.3%
2	92.3	-2.8%	2.1%
3	89.7	-1.0%	4.3%
4	92.6	-1.4%	1.7%
5	91.8	-3.1%	1.3%
6	96.2	0.8%	-0.4%
7	92.9	-3.2%	0.2%
8	94.3	-2.5%	1.5%
9	90.4	-2.5%	5.2%
10	84.3	-1.4%	9.5%
11	83.1	3.5%	9.8%
12	88.2	4.8%	3.4%
13	94.0	2.7%	-2.0%
14	88.7	5.9%	-5.8%
15	88.7	0.7%	-5.9%
16	86.8	-0.7%	-6.7%

4000K | Rf: 87.6 | Rg: 96.8

Color Vector Graphic

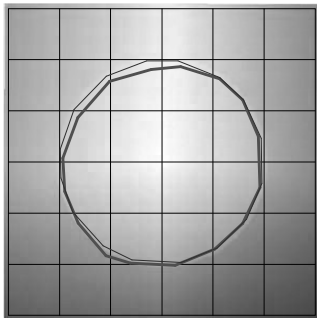

■ Test ■ Reference

HUE BIN	Rf	GRAPHIC SHIFTS %	
		CHROMA	HUE
1	88.9	-2.4%	2.5%
2	93.3	-0.4%	0.8%
3	94.8	-1.0%	-0.6%
4	87.9	-4.9%	-3.6%
5	85.3	-9.4%	-2.6%
6	90.2	-6.0%	0.2%
7	85.3	-7.6%	4.6%
8	83.7	-4.1%	8.2%
9	79.5	-1.1%	13.8%
10	78.6	1.5%	12.1%
11	83.5	6.4%	7.8%
12	90.9	3.6%	-1.1%
13	88.3	1.7%	-6.3%
14	91.9	-0.4%	-2.2%
15	84.5	-0.9%	-5.5%
16	84.7	-1.1%	-4.4%

PROJECT	FIXTURE TYPE	DATE
---------	--------------	------

TRULINE .5A WARM DIM

24VDC, 5/8" DRYWALL PLASTER-IN LED SYSTEM

DESIGNED BY GREGORY KAY | ASSEMBLED IN AMERICA

REV 12.12.22

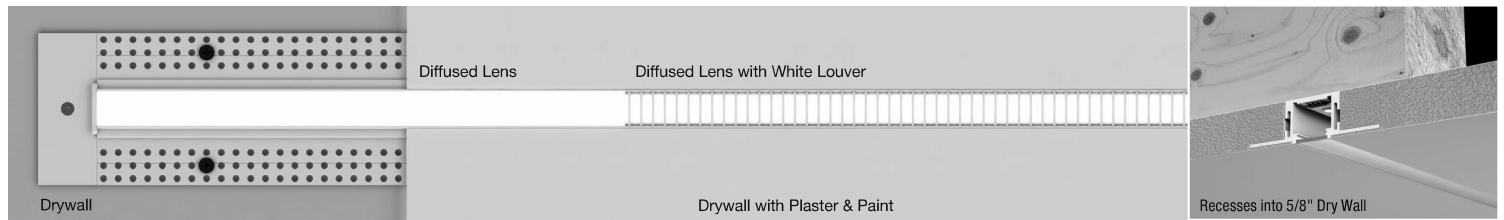

DESCRIPTION

PureEdge pioneered the TruLine .5A Plaster-in 24VDC LED system that Recesses within 5/8" drywall, without any joist modification. Redefining the relationship between Lighting and Interior Design, this Innovative and highly Efficient system blends seamlessly into the drywall, becoming part of the Architecture. The slim extrusions, LED strips, and lenses are field-cuttable and ordered in 1' increments (up to 20' before re-feeding). Multiple runs of channel mount flawlessly together providing smooth and Glare-free general illumination using Designer-grade Color Rendering LEDs (95+ CRI). With the ability to run in vertical, horizontal, and diagonal directions, the compositions are truly endless. Warm Dim technology (27D & 30D) mimics an incandescent atmosphere by decreasing the color temperature as you dim. Our Warm Dim strips can be dimmed all the way down to a soothing amber hue at 1800K, reminiscent of candlelight along the halogen curve. Click here for all [Other Color Temperatures](#). Coordinate installation with electrical and drywall contractors. Includes a 5-year pro-rated warranty. For custom designs and quotes, send drawings to design@PureEdgeLighting.com.

DESIGN NOTE

TruLine .5A can be installed on a single surface, join runs on multiple planes from wall to ceiling, or from one wall to an adjacent wall. Use TruLine .5A Build-It-Yourself (BIY) with pre-formed components to create desired configurations, including Mitered Picture Frame and Outside or Inside Corners for Room Wrapping installations. Create square or rectangular compositions with TruQuad .5A.

ORDERING & INSTALLATION

TruLine .5A can be secured to studs spaced 13"-24" apart or between studs with provided mounting straps. Requires Remote Power Supply (ordered separately) In-Wall Mounting Kits are available for select power supplies. Order in 1' increments, field-cuttable to any length.

MAXIMUM LENGTHS BEFORE RE-FEEDING

- 5WDC, 4.8 watts per foot - 20'

LAMP

- Warm Dim: **27D** and **30D** dim down to 1800K, resembling halogen light sources
- Lumen Performance: 398lm/ft at 3000K (30D) 5W per foot
- Designer Grade High CRI 95+ LEDs
- Average Lamp Life 50,000 hours
- For additional color temperatures refer to other specifications

REMOTE POWER SUPPLIES*, DIMMERS & CONTROLS (SOLD SEPARATELY)

24VDC, Class 2 wiring

- **UNI Driver: Universal Dimming (TRIAC, ELV, 0-10V)**
- **Lutron Hi-Lume/Ecosystem**

*In-Wall Mounting and drop ceiling Kits available for select power supplies

APPLICATIONS

Designed for any Indoor space with drywall, including Damp locations. Ideal applications in Residential, Commercial, Retail, and Hospitality environments.

COMPLIANCE

Title 24 JA8 listed when used with PureEdge remote Universal power supplies, ETL, RoHS, Class 2, Damp Location, Made in USA.

For quick & easy reference, plus the most up-to-date pricing, use our [TruLine .5A Configurator](#)

PureEdge is the Original Designer of 5/8" Drywall Lighting Products with the Most Experience in the industry.

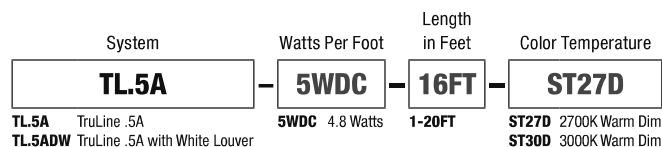

PROJECT		FIXTURE TYPE		DATE	
---------	--	--------------	--	------	--

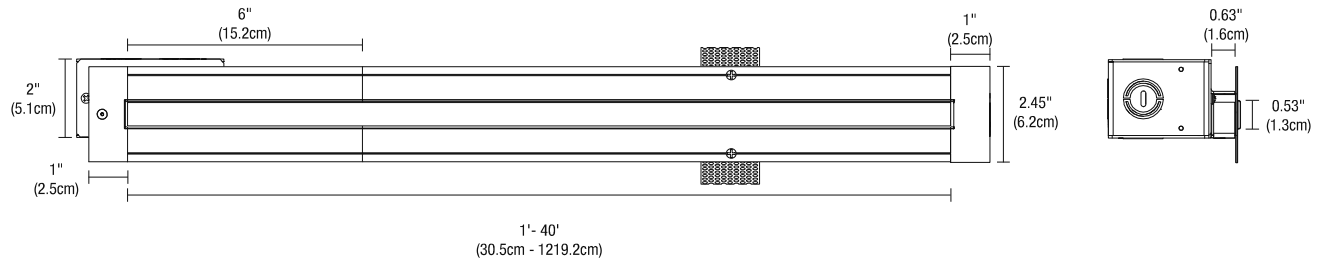

INCLUDED COMPONENTS

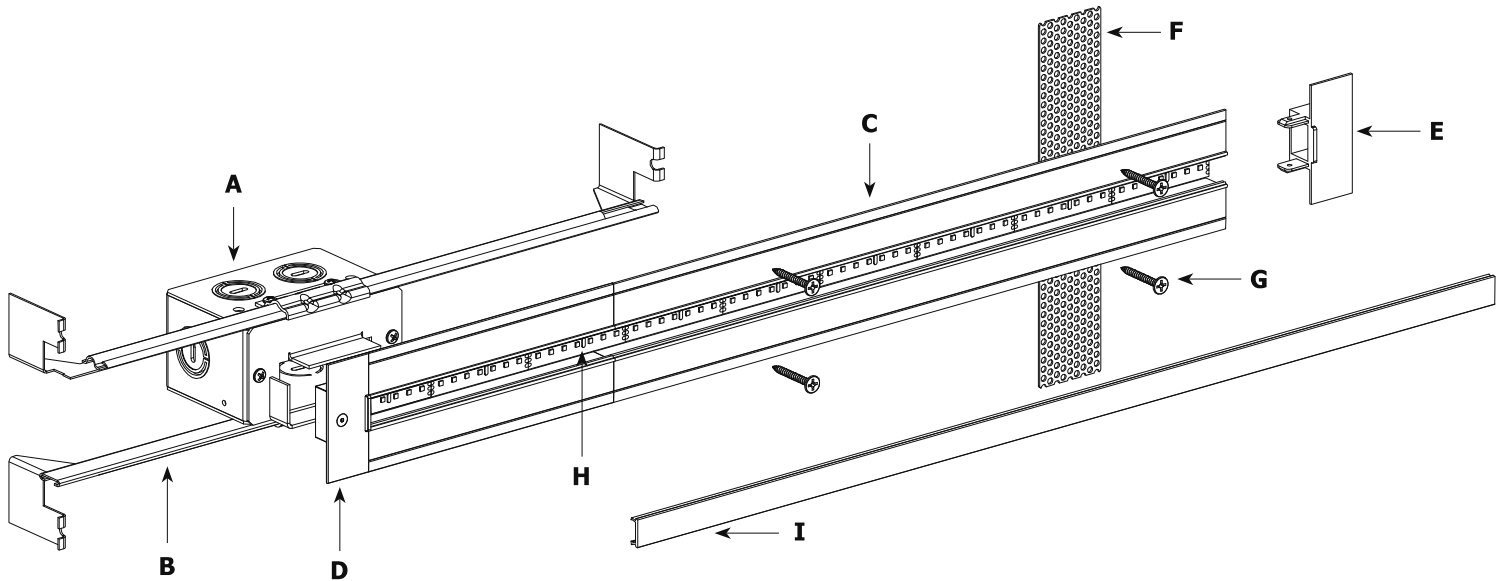

A. JUNCTION BOX

Mounts behind drywall with Adjustable Mounting Bars. Low Voltage 24VDC wires from Remote Power Supply connect to LED wires inside box. Junction Box opening is covered by channel. Required at the beginning of each run and necessary to rough-in electrical before TruLine installation. Junction Box is also included with each TruLine channel order

B. ADJUSTABLE MOUNTING BARS

Provide flexibility for mounting in a variety of spaces and orientations. May be secured to studs that are spaced 13"-24" apart.

C. TRULINE .5A CHANNEL

5/8" deep extrusion houses single row of LED Strip.

D. POWER END CAP

Provides a finished look and prevents light leak at the feed-end of a run where LED Strip enters channel.

E. TAKE-UP BOX

Prevents dark spots at the end of a run by tucking excess LED Strip safely behind the wall.

F. MOUNTING STRAP

Secures channel to drywall when wall stud is unavailable.

G. DRYWALL SCREW

Secures channel to drywall and stud.

H. LED STRIP

Your selection of LED Strip.

I. LENS

0.5" wide diffused white lens projects a clean line of light without LED pixelation.

PROJECT		FIXTURE TYPE		DATE	
---------	--	--------------	--	------	--

TRULINE .5A WARM DIM

24VDC, 5/8" DRYWALL PLASTER-IN LED SYSTEM

REV 12.12.22

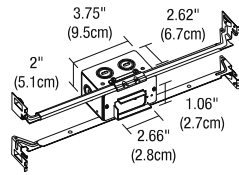
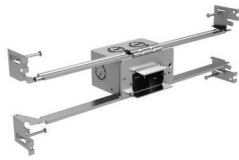

JUNCTION BOX ROUGH-IN COMPONENT

One Junction Box is included with TruLine .5A. Order additional Junction Box separately to rough-in electrical wiring before drywall installation. Quick shipment available.

System	Size	Component
TL.5A	1RE	JBOX
TL.5A TruLine .5A	1RE 1" Rectangle	JBOX Junction Box

DELIVERED LUMENS

NOMINAL LAMP DATA	ST5A	
WATTS PER FOOT	4.8W	
COLOR TEMPERATURE	27D	30D
LUMENS PER FOOT (lm/ft)	380	398
LUMENS PER WATT (lm/w)	79	83
CRI	94+	94+

To determine the necessary wire gauge use our [Voltage Drop Calculator](#)

LENGTH LOAD CHARTS

5 WATTS PER FOOT

LENGTH IN FEET	WATTS	LENGTH IN FEET	WATTS	LENGTH IN FEET	WATTS	LENGTH IN FEET	WATTS
1	5	6	30	11	54	16	78
2	10	7	34	12	58	17	82
3	16	8	40	13	64	18	88
4	20	9	44	14	68	19	92
5	24	10	48	15	72	20	96

PROJECT		FIXTURE TYPE		DATE	
---------	--	--------------	--	------	--

LED STRIP TM30 DATA

24VDC, 5/8" DRYWALL PLASTER-IN LED SYSTEM

TM-30-15 DATA: The data below is for bare LED Warm Dim Strip. Consistent color temperatures throughout a single strip and among multiple strips is possible through a 3 phase binning process in which each order is inspected with a color meter to ensure uniformity.

2700D | Rf: 90.7 | Rg: 101.1

Color Vector Graphic

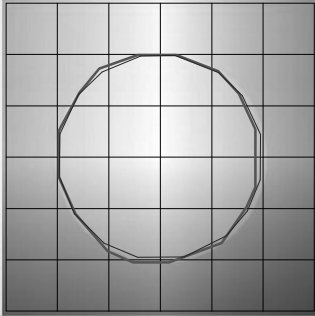

■ Test ■ Reference

HUE BIN	Rf	GRAPHIC SHIFTS %	
		CHROMA	HUE
1	90.9	-4.1%	1.1%
2	91.8	-2.2%	3.2%
3	89.0	0.2%	5.0%
4	92.9	-1.1%	0.8%
5	93.9	1.1%	1.7%
6	93.3	3.3%	0.0%
7	93.1	-0.5%	-1.9%
8	97.2	-0.3%	-0.9%
9	93.4	-1.0%	3.2%
10	89.9	-0.1%	5.6%
11	87.0	4.7%	7.2%
12	89.2	5.8%	-0.2%
13	89.1	3.5%	-6.7%
14	86.3	4.1%	-9.2%
15	91.4	-2.0%	-3.6%
16	84.7	-2.1%	-10.3%

3000D | Rf: 90.6 | Rg: 101.1

Color Vector Graphic

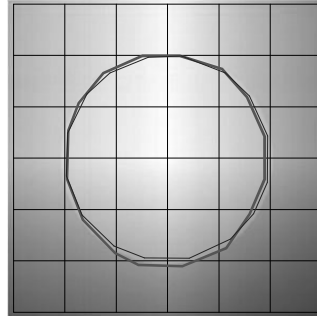

■ Test ■ Reference

HUE BIN	Rf	GRAPHIC SHIFTS %	
		CHROMA	HUE
1	91.5	-3.5%	1.3%
2	92.2	-1.8%	3.0%
3	89.3	0.5%	4.8%
4	92.7	-1.1%	0.6%
5	93.3	0.5%	1.4%
6	93.8	2.7%	-0.8%
7	91.2	-2.1%	-0.2%
8	97.0	-0.5%	-0.7%
9	92.5	-0.7%	3.8%
10	88.3	0.9%	7.1%
11	87.5	3.9%	7.6%
12	88.2	6.2%	-0.2%
13	89.9	3.4%	-6.0%
14	86.9	4.4%	-8.5%
15	91.9	-1.9%	-2.9%
16	84.7	-1.3%	-10.6%

PROJECT	FIXTURE TYPE	DATE
---------	--------------	------