

FLEX NEON LRT7 BENDS LEFT/RIGHT 0.7" THREE SIDED LENS

24VDC INDOOR / OUTDOOR 2W | 5W | 7W STATIC WHITE, WARM DIM & TUNABLE WHITE

ASSEMBLED IN AMERICA

REV 04.26.21

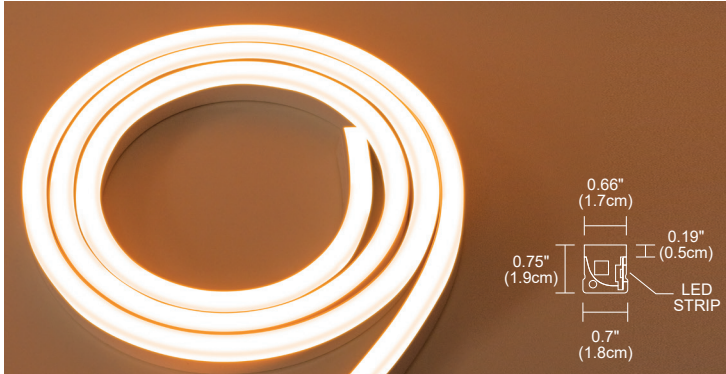

DESCRIPTION

LRT7 Flexible Neon Bends Left to Right with a 0.7" wide three-sided lens, offering superior color quality and performance while creating uniform illumination without visible dots. Flex Neon can be Flush or Surface Mounted. Choose from 9 different color temperatures ranging from 2000K to 3500K, including two Warm Dim options of 2400K (24D) or 2700K (27D) and Tunable White (2K6K). Tunable White technology grants independent control for adjusting LED color temperature and brightness. Use with two dimmers or, our proprietary Tunable White Controller (CDMX-1) for fast and accurate adjustment with three pre-set scenes (Ordered separately). The (W) is an IP65 rated wet location fixture featuring watertight barrel connections. The (S) Seamless (for continuous, seamless runs), is rated for Indoor Damp Locations ONLY and uses Class 2 bare wire connectors. Fixture includes a 5-year pro-rated warranty. Patent pending.

SPECIFICATIONS

Flat top view 0.5" wide 0.75" high

INPUT	24VDC with 5" leads
POWER SUPPLIES	Remote 24VDC power supply required
POWER CONSUMPTION	2.5, 4.4 or 7.3 watts per foot
INCREMENTS	2.4" or 3"
MAX LENGTH	2W- 40ft, 5W- 20ft, 7W- 12ft
MATERIAL	UV Resistant PVC
OPERATING TEMPERATURE	-4° F (-20° C) to 122° F (+50° C)
AVERAGE LED LIFE	50,000 hrs
WARRANTY	5 Year pro-rated
COMPLIANCE	Class 2 Wiring Indoor Applications, Outdoor Wet Location with Water Tight Barrel Connectors IP65 Rated, ETL listed, Title 24

REMOTE POWER SUPPLIES*, DIMMERS & CONTROLS (SOLD SEPARATELY)

- UNI Driver: Universal Dimming (TRIAC, ELV, 0-10V) with corresponding dimmer
- 0-10V
- Lutron Hi-Lume®
- Color Changing (DMX)

LUMEN PERFORMANCE AT 3000K 7W PER FOOT (SEE COMPLETE CHART PG 2)

LUMEN OUTPUT	560 lm/ft	EFFICIENCY	77 lm/watt
CRI	94	R9	76
BEAM ANGLE	120°	BEAM TOLERANCE	+/- 30CCT

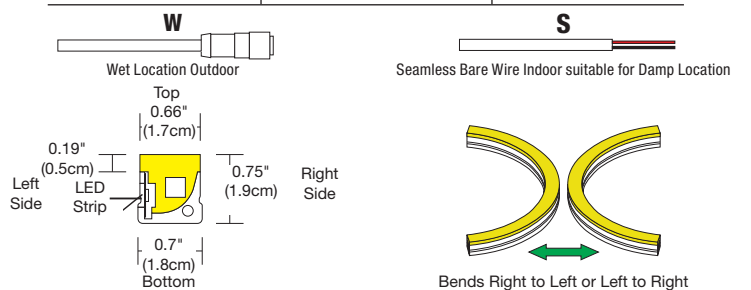
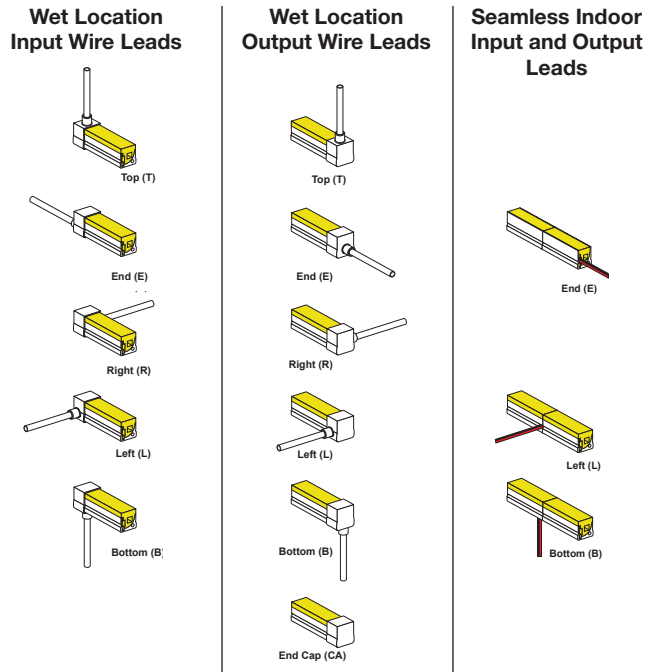

System	Viewing Angle Model Shape	Wattage	Length in Inches	Color Temperature	5" Input Wire Feed	5" Output Wire	Environment	
FN	LRT7	2W	120	27K	E	L	W	
FN Flex Neon 24V	LRT7 Left or Right side bend Three Sided Lens 0.6" x 0.75"	2W 2.5 watts per foot 5W 5 watts per foot 7W 7.5 watts per foot	6-480 (40ft max) 6-240 (20ft max) 6-144 (12ft max)	20K 2000K Candle Light White 22K 2200K Amber White 24K 2400K Very Warm White 24D* 2400K Warm Dim, Dims to 1800K 27K 2700K Incandescent White	27D* 2700K Warm Dim, Dims to 2000K 30K 3000K Warm White 35K 3500K Neutral White 2K6K* Tunable White 2000K-6500K	T* Top Power Input Wire E* End Power Input Wire L Left Power Input Wire R* Right Power Input Wire B Bottom Power Input Wire	T* Top Wire Lead Out E End Wire Lead Out L Left Wire Lead Out R* Right Wire Lead Out B Bottom Wire Lead Out CA Cap at end, no feed through	S Seamless Indoor/ Damp location bare wire leads Bottom and Left Feed Only W Outdoor wet location Barrel Connector cable leads

*Static & Tunable White: 2.4" increments Warm Dim: 3" increments *5 Watt Only *Not available for Seamless indoor

PROJECT	FIXTURE TYPE	DATE
---------	--------------	------

FLEX NEON LRT7 BENDS LEFT/RIGHT 0.7" THREE SIDED LENS

24VDC INDOOR / OUTDOOR 2W | 5W | 7W STATIC WHITE, WARM DIM & TUNABLE WHITE

REV 04.26.21

Lamp Data: Lamp Data for Flex Neon LRT7

WATTS PER FOOT	FN-LRT7																							
	2W							5W							7W									
COLOR TEMPERATURE	20K	22K	24K	27K	30K	35K	57K	20K	22K	24K	24D*	27K	27D*	30K	35K	57K	20K	22K	24K	27K	30K	35K	40K	57K
LUMENS PER FOOT (lm/ft)	143	158	175	193	211	262	278	278	308	339	425	371	465	424	461	491	374	420	466	513	560	642	698	742
LUMENS PER WATT (lm/w)	57	63	70	77	84	105	111	63	70	77	89	84	97	96	105	112	51	58	64	70	77	88	96	102
CRI	92	92	92	92	92	92	92	92	92	92	92	92	92	92	92	92	92	92	92	92	92	92	92	92

WATTS PER FOOT	2K6K*							
	5w							
COLOR TEMPERATURE	20K	24K	27K	30K	35K	40K	57K	65K
LUMENS PER FOOT (lm/ft)	288	323	301	312	324	320	318	317
LUMENS PER WATT (lm/w)	56	63	67	68	69	70	71	72
CRI	92	93	93	92	92	92	84	85

*Tunable White has a variance in color temperature due to the curvature of the material.

Drawings: Flex Neon LRT7

Seamless (S) Connection Indoor / Damp Rated with No End Cap

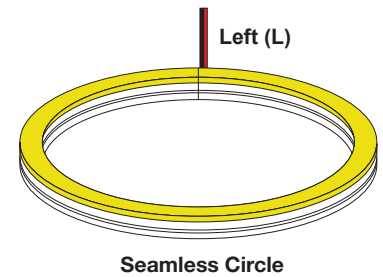
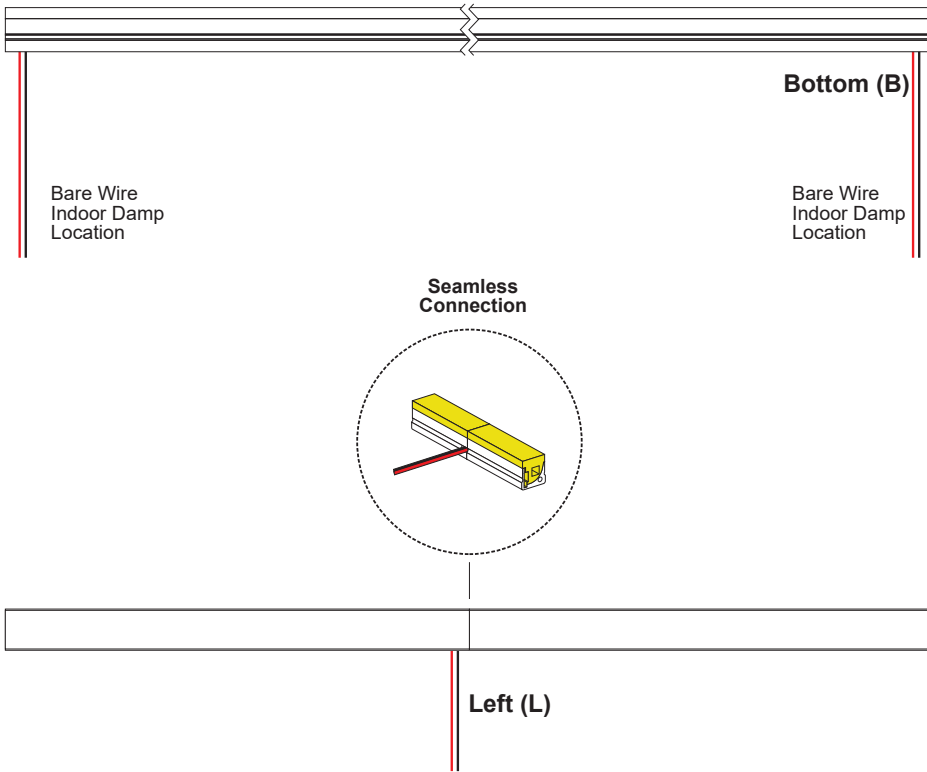

Wet (W) Outdoor Location with End Cap

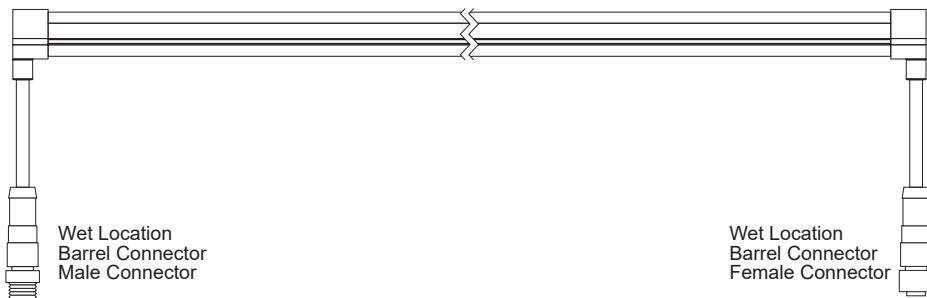

PROJECT	FIXTURE TYPE	DATE
---------	--------------	------

FLEX NEON LRT7 BENDS LEFT/RIGHT 0.7" THREE SIDED LENS

24VDC INDOOR / OUTDOOR 2W | 5W | 7W STATIC WHITE, WARM DIM & TUNABLE WHITE

REV 04.26.21

LENGTH CHART Actual lengths for Flex Neon LRT7

LENGTH CHART - STATIC WHITE

Ordering Code (Nominal Size)	Actual Length	Ordering Code (Nominal Size)	Actual Length	Ordering Code (Nominal Size)	Actual Length	Ordering Code (Nominal Size)	Actual Length	Ordering Code (Nominal Size)	Actual Length	Ordering Code (Nominal Size)	Actual Length	Ordering Code (Nominal Size)	Actual Length
3	3.15	72	72.75	142	142.35	212	211.95	281	281.55	348	348.75	416	415.95
5	5.55	75	75.15	144	144.75	214	214.35	284	283.95	351	351.15	418	418.35
8	7.95	77	77.55	147	147.15	216	216.75	286	286.35	353	353.55	420	420.75
10	10.35	80	79.95	149	149.55	219	219.15	288	288.75	356	355.95	423	423.15
12	12.75	82	82.35	152	151.95	221	221.55	291	291.15	358	358.35	425	425.55
15	15.15	84	84.75	154	154.35	224	223.95	293	293.55	360	360.75	428	427.95
17	17.55	87	87.15	156	156.75	226	226.35	296	295.95	363	363.15	430	430.35
20	19.95	89	89.55	159	159.15	228	228.75	298	298.35	365	365.55	432	432.75
22	22.35	92	91.95	161	161.55	231	231.15	300	300.75	368	367.95	435	435.15
24	24.75	94	94.35	164	163.95	233	233.55	303	303.15	370	370.35	437	437.55
27	27.15	96	96.75	166	166.35	236	235.95	305	305.55	372	372.75	440	439.95
29	29.55	99	99.15	168	168.75	238	238.35	308	307.95	375	375.15	442	442.35
32	31.95	101	101.55	171	171.15	240	240.75	310	310.35	377	377.55	444	444.75
34	34.35	104	103.95	173	173.55	243	243.15	312	312.75	380	379.95	447	447.15
36	36.75	106	106.35	176	175.95	245	245.55	315	315.15	382	382.35	449	449.55
39	39.15	108	108.75	178	178.35	248	247.95	317	317.55	384	384.75	452	451.95
41	41.55	111	111.15	180	180.75	250	250.35	320	319.95	387	387.15	454	454.35
44	43.95	113	113.55	183	183.15	252	252.75	322	322.35	389	389.55	456	456.75
46	46.35	116	115.95	185	185.55	255	255.15	324	324.75	392	391.95	459	459.15
48	48.75	118	118.35	188	187.95	257	257.55	327	327.15	394	394.35	461	461.55
51	51.15	120	120.75	190	190.35	260	259.95	329	329.55	396	396.75	464	463.95
53	53.55	123	123.15	192	192.75	262	262.35	332	331.95	399	399.15	466	466.35
56	55.95	125	125.55	195	195.15	264	264.75	334	334.35	401	401.55	468	468.75
58	58.35	128	127.95	197	197.55	267	267.15	336	336.75	404	403.95	471	471.15
60	60.75	130	130.35	200	199.95	269	269.55	339	339.15	406	406.35	473	473.55
63	63.15	132	132.75	202	202.35	272	271.95	341	341.55	408	408.75	476	475.95
65	65.55	135	135.15	204	204.75	274	274.35	344	343.95	411	411.15	478	478.35
68	67.95	137	137.55	207	207.15	276	276.75	346	346.35	413	413.55	480	480.75
70	70.35	140	139.95	209	209.55	279	279.15						

LENGTH CHART - WARM DIM

Ordering Code (Nominal Size)	Actual Length	Ordering Code (Nominal Size)	Actual Length	Ordering Code (Nominal Size)	Actual Length	Ordering Code (Nominal Size)	Actual Length	Ordering Code (Nominal Size)	Actual Length	Ordering Code (Nominal Size)	Actual Length	Ordering Code (Nominal Size)	Actual Length
3	3.75	75	75.75	138	138.75	207	207.75	276	276.75	345	345.75	414	414.75
6	6.75	78	78.75	141	141.75	210	210.75	279	279.75	348	348.75	417	417.75
9	9.75	81	81.75	144	144.75	213	213.75	282	282.75	351	351.75	420	420.75
12	12.75	84	83.75	147	147.75	216	216.75	285	285.75	354	354.75	423	423.75
15	15.75	87	86.75	150	150.75	219	219.75	288	288.75	357	357.75	426	426.75
18	18.75	90	89.75	153	153.75	222	222.75	291	291.75	360	360.75	429	429.75
21	21.75	93	92.75	156	156.75	225	225.75	294	294.75	363	363.75	432	432.75
24	24.75	96	95.75	159	159.75	228	228.75	297	297.75	366	366.75	435	435.75
27	27.75	99	98.75	162	162.75	231	231.75	300	300.75	369	369.75	438	438.75
30	30.75	102	101.75	165	165.75	234	234.75	303	303.75	372	372.75	441	441.75
33	33.75	105	104.75	168	168.75	237	237.75	306	306.75	375	375.75	444	444.75
36	36.75	108	107.75	171	171.75	240	240.75	309	309.75	378	378.75	447	447.75
39	39.75	111	110.75	174	174.75	243	243.75	312	312.75	381	381.75	450	450.75
42	42.75	114	113.75	177	177.75	246	246.75	315	315.75	384	384.75	453	453.75
45	45.75	117	116.75	180	180.75	249	249.75	318	318.75	387	387.75	456	456.75
48	48.75	120	119.75	183	183.75	252	252.75	321	321.75	390	390.75	459	459.75
51	51.75	123	122.75	186	186.75	255	255.75	324	324.75	393	393.75	462	462.75
54	54.75	126	125.75	189	189.75	258	258.75	327	327.75	396	396.75	465	465.75
57	57.75	129	128.75	192	192.75	261	261.75	330	330.75	399	399.75	468	468.75
60	60.75	132	131.75	195	195.75	264	264.75	333	333.75	402	402.75	471	471.75
63	63.75	135	133.75	198	198.75	267	267.75	336	336.75	405	405.75	474	474.75
66	66.75			201	201.75	270	270.75	339	339.75	408	408.75	477	477.75
69	69.75			204	204.75	273	273.75	342	342.75	411	411.75	480	480.75
72	72.75												

PROJECT		FIXTURE TYPE		DATE	
---------	--	--------------	--	------	--



EXT.7 Light Channel

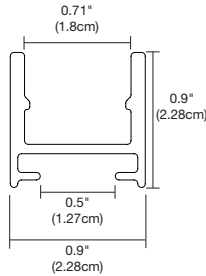

INTERIOR OR EXTERIOR CHANNEL

Interior or exterior channel features an aluminum extrusion with mounting clips included every 2ft. Available in length up to 10ft long and may be cut at the job site.

Product	Length	Finish
EXT.7	10FT	SA
EXT.7 Extrusion 0.7" Wide	4FT 4 Feet 5FT 5 Feet 8FT 8 Feet 10FT 10 Feet	SA Satin Aluminum WH White

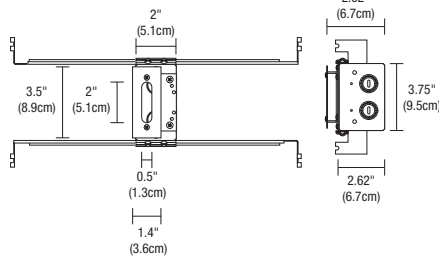
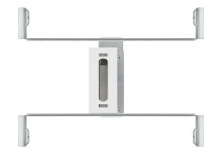

1" RECTANGLE CANOPY & J-BOX (INCLUDED WITH 1R SELECTED IN FIXTURE ORDERING CODE)

The Slim-Profile Junction Box with Hanger Bars mounts to studs spaced between 14.5" and 25" apart behind drywall. Allows low voltage DC wires from Remote Power Supply to connect to channel wires. The Junction Box opening is covered by the fixture for a clean, safe connection. Includes a Goof Plate, for poor plastering around J-box.

System	Canopy	Product
C	1RE	JBOX
C Channel	1RE 1" Rectangle	JBOX Junction Box

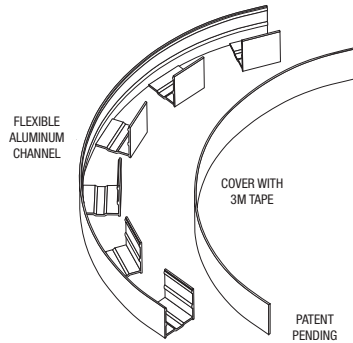
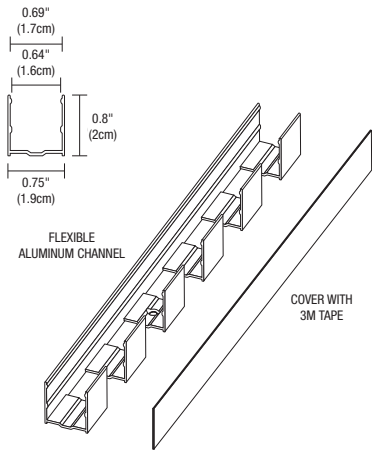

FLEXIBLE ALUMINUM CHANNEL

Flexible aluminum channel is designed to work specifically with Flex Neon for practical and professional mounting. The channel can make large radius 90° turns, perfect circles and sweeping bends that follow the form of architectural details, soffits, signage and more - consider using this channel to guide your linear LED lighting design. Patent Pending.

Product	Length	Finish
FX-EXT.7	4FT	WH
FX-EXT.7 Flexible Extrusion 0.7" Wide	4FT 4 Feet	BK Black WH White



LCS.6-MCL

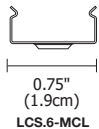

LCS.6-MCL

MOUNTING CLIPS

LCS.6 mounting clips are provided with every 12" of Flex Neon and may be ordered separately as replacement parts. The LCS.6-MCL-075 rotates Light Channel up to 75 degrees. LCS.6-MCL-90 mounts Light Channel at a 90 degree angle.



LCS.6-MCL-075

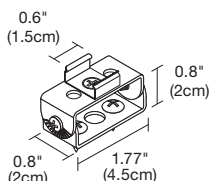

LCS.6-MCL-075

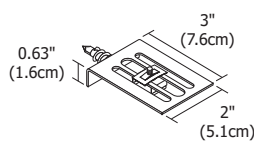

LCS.6-MCL-90

System	Product	Type
LCS.6	MCL	075
LCS.6 Flex Neon Left Right 0.6"	MCL Mounting Clip	Standard, Leave Blank 075 Adjust 0-75° 90 Mounts at 90°

PROJECT	FIXTURE TYPE	DATE



FLEX NEON OUTDOOR ACCESSORIES AND J-BOX'S

24VDC INDOOR / OUTDOOR 2W | 5W | 7W STATIC WHITE, WARM DIM & TUNABLE WHITE



REV 04.26.21

FLEX NEON TIE STRAP

Use for mounting to poles for extra support, every 6"-12" (30 per package).



Product	Type
SS	ST
SS LED Flex Neon	ST Tie Strap

DIRECT BURIAL LOCATION CABLE ORDER PER FOOT

Our Direct Burial, 2 Conductor Plus ground, 12 Gauge Cable is a durable and adaptable cable suitable for transmitting power, control, and switching in outdoor wet and in ground environments. Keep within 60 ft between fixture and power supply. Cable sold by the foot, simply specify the length needed by the foot.



Product	Gauge	Cable
DB	12G	2C
DB Direct Burial	12G 12 Gauge	2C 2 Conductor

WET AND DAMP LOCATION CABLE ORDER PER FOOT

Our Wet Location, 5 Conductor, 14 Gauge Cable is a durable and adaptable cable suitable for transmitting power, control, and switching in indoor and outdoor wet and damp environments. Cable sold by the foot, simply specify the length needed by the foot. Keep within 50 ft between fixture and power supply. Cable sold by the foot, simply specify the length needed by the foot.

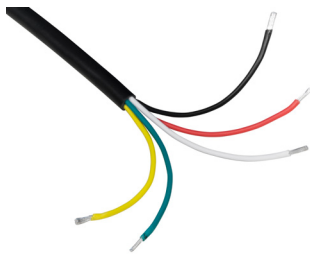

Product	Gauge	Cable
OC	14G	5C
OC Outdoor Cable	14G 14 Gauge	5C 5 Conductor

WET LOCATION JUNCTION BOX

Wet-rated low voltage Splice Box with connectors.

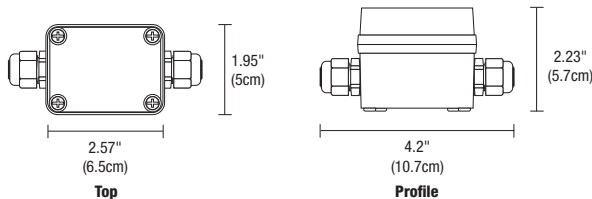

Product	Type	Option
2RE	JBOX	W
2RE 2" Rectangle	JBOX Junction Box	W Wet Location

PROJECT	FIXTURE TYPE	DATE
---------	--------------	------



FLEX NEON OUTDOOR ACCESSORIES AND J-BOX'S

24VDC INDOOR / OUTDOOR 2W | 5W | 7W STATIC WHITE, WARM DIM & TUNABLE WHITE



REV 04.26.21



WET LOCATION JUNCTION BOX WITH 6" POWER CABLE

This watertight, multi-fixture Junction Box is especially designed for lighting in wet and damp locations. It is versatile, rugged and simple to install. The Junction Box comes standard with a 6" Flexible Cable providing easy, safe, and reliable connections for 24V low voltage luminaires. This box is approved for indoor and outdoor usage and complies with all the requirements of UL1241 and the National Electric Code.

Product	Canopy	Product	Size	Option
SS	2RE	JBOX	6IN	W
SS LED Soft Strip Flex Neon	2RE 2" Rectangle	JBOX Junction Box	6IN 6" Four Wire Connection	W Wet Location

POWER CABLE CONNECTOR WET LOCATION

The flexible power cable connector is designed to work in outdoor environments for safe and reliable connections. This Flexible Connector is easy to install and configure, helping you create innovative lighting designs in an outdoor commercial or residential space.

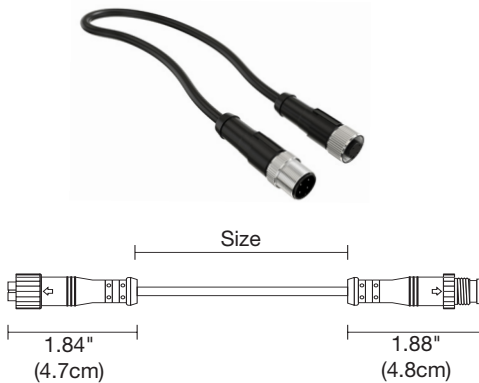

Product	Type	Size	Option
SS	CFX	12IN	W
SS Soft Strip and Flex Neon	CFX Flexible 4 Wire Connector	12IN 12" 96IN 96"	W Wet Location

WET LOCATION T-CONNECTOR

Our Wet Location T-Connector is a robust rugged design especially suited to withstand the challenges of damp and wet environments. This unique T-Connector has one Male and two Female Connectors and is suitable for multiple indoor and outdoor uses. Versatile design is easy to use, making installation quick and efficient.



Product	Type	Option
SS	TC	W
SS Soft Strip and Flex Neon	TC T-Connector 4 Wire	W Wet Location

PROJECT	FIXTURE TYPE	DATE
---------	--------------	------

0-10 VOLT (010) POWER SUPPLIES & RECOMMENDED DIMMERS

ORDERING CODE	PSB-25W-010-24VDC	PSB-60W-010-24VDC	PSB-96W-010-24VDC
SPECIFICATIONS			
MAXIMUM LOAD	25W	60W	96W
INPUT VOLTAGE	120-277VAC	120-277VAC	120-277VAC
OUTPUT VOLTAGE	24VDC	24VDC	24VDC
DIMENSIONS	12.4" X 3.12" X 2.18"	12.4" X 3.12" X 2.18"	12.4" X 3.12" X 2.18"
CLASSIFICATION	CLASS 2	CLASS 2	CLASS 2
T-BAR MOUNTING	PSB-25W-010-24VDC-TB	PSB-60W-010-24VDC-TB	PSB-96W-010-24VDC-TB
IN-WALL MOUNTING	PSB-25W-010-24VDC-IW	PSB-60W-010-24VDC-IW	PSB-96W-010-24VDC-IW

0-10 VOLT (010) POWER SUPPLIES & RECOMMENDED DIMMERS

ORDERING CODE	PSB-2X96W-010-24VDC	PSB-3X96W-010-24VDC	PSB-4X96W-010-24VDC
SPECIFICATION			
MAXIMUM LOAD	2X96W	3X96W	4X96W
INPUT VOLTAGE	120-277VAC	120-277VAC	120-277VAC
OUTPUT VOLTAGE	24VDC	24VDC	24VDC
DIMENSIONS	12.15" X 6.48" X 2.18"	14" X 10" X 3"	17" X 13" X 3"
CLASSIFICATION	CLASS 2	CLASS 2	CLASS 2
T-BAR MOUNTING	PSB-2X96W-010-24VDC-TB	PSB-3X96W-010-24VDC-TB	PSB-4X96W-010-24VDC-TB
IN-WALL MOUNTING	PSB-2X96W-010-24VDC-IW	N/A	N/A

DIMMING & CONTROLS

PHILIPS SUNRISE: SR1200ZTUNV	•	•	•
LUTRON DIVA: DVTV-WH, DVSTV-WH	•	•	•
LUTRON NOVA T: NTSTV-DV-XX	•	•	•
LUTRON GRAFIX EYE QS: QSGRJ-XP	•	•	•
LUTRON RADIO RA2: RRD-10ND	•	•	•
LEVITON: LEV40050	•	•	•
LEVITON IP710-LFZ	•	•	•
LEGRAND: ADPD4FBL3P2W4	•	•	•

- Flicker free dimming
- Aluminum casing for optimal heat dissipation
- Isolated output power per NEC and UL safety requirements
- UL & ETL recognized/ listed, meets UL 8750, 1310 requirements

- Auto-reset; short circuit, overload and thermal protection
- Class 2 power supply
- Efficient, High power factor > 90

**Up + Down Light fixtures and Systems can be controlled individually or together depending on the power supply selection.

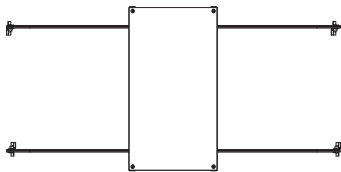

T-BAR Mounting Kit: Includes power supply, box cover, and T-bar hangers for installing Junction Box above ceiling with in easy reach. Comes with 4ft of 14 gauge pair Teflon cables with quick secure connectors.

Ordering Codes:
 PSB-25W-010-24VDC-TB,
 PSB-60W-010-24VDC-TB,
 PSB-96W-010-24VDC-TB,
 PSB-2X96W-010-24VDC-TB
 PSB-3X96W-010-24VDC-TB
 PSB-4X96W-010-24VDC-TB

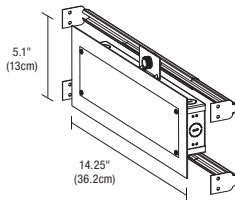

5.1" x 14.25" In-Wall Mounting Kit: Includes power supply, box cover and stud hangers for installing Junction Box in wall. Select "IW" in the options section of compatible power supply ordering codes if an In-Wall Mounting Kit is needed.

Ordering Codes: PSB-25W-010-24VDC-IW, PSB-60W-010-24VDC-IW, PSB-96W-010-24VDC-IW

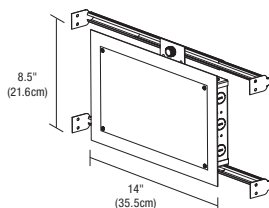

8.5" x 14" In-Wall Mounting Kit: Includes power supply, box cover and stud hangers for installing Junction Box in wall. Select "IW" in the options section of compatible power supply ordering codes if an In-Wall Mounting Kit is needed.

Ordering Codes: PSB-2X96W-010-24VDC-IW

PROJECT	FIXTURE TYPE	DATE
---------	--------------	------

SAMPLE WIRING DIAGRAMS 24VDC 010

Application: 0-10V Dimming Applications For Static White and Warm Dim

Dimming: Dimmable with 0-10V dimmers: Signify (Phillips) Sunrise: SR1200ZTUNV, Leviton Dimmers: LEV40050, IP710-LFZ, *IP710-DLZ *(Built in LED locator light) Legrand Dimmer: ADPD4FBL3P2W4 Lutron Systems: Lutron GRAFIX Eye QS Main Unit (with DRX-TVI) Radio Ra2 (with GRX-TVI)

0-10V DIMMER

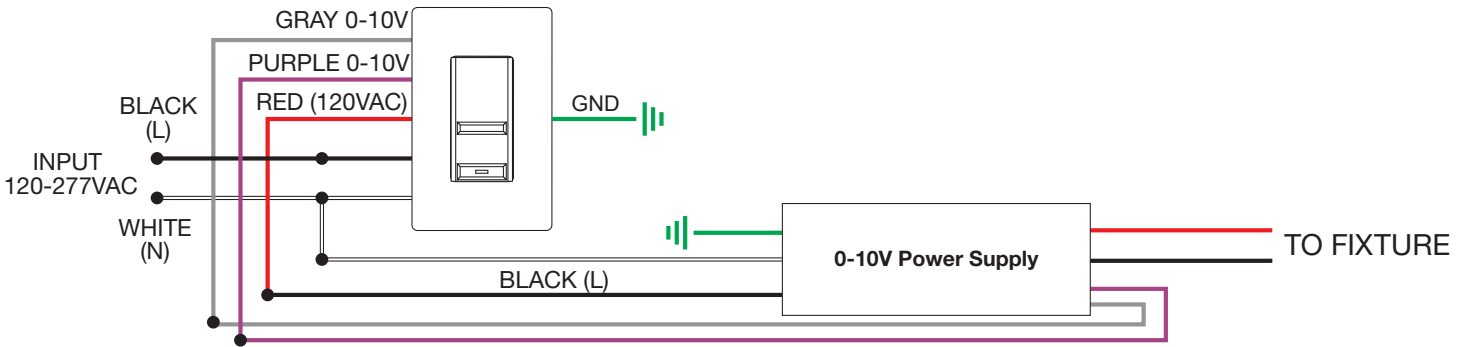

Application: Dual 0-10V dimming for Static White

Dimming: Dimmable with Dual 0-10V dimmers: Signify (Phillips) Sunrise: SR1200ZTUNV, Leviton Dimmers: LEV40050, IP710-LFZ, *IP710-DLZ *(Built in LED locator light), Legrand Dimmer: ADPD4FBL3P2W4, Lutron Systems: Lutron GRAFIX Eye QS Main Unit (with DRX-TVI) Radio Ra2 (with GRX-TVI)

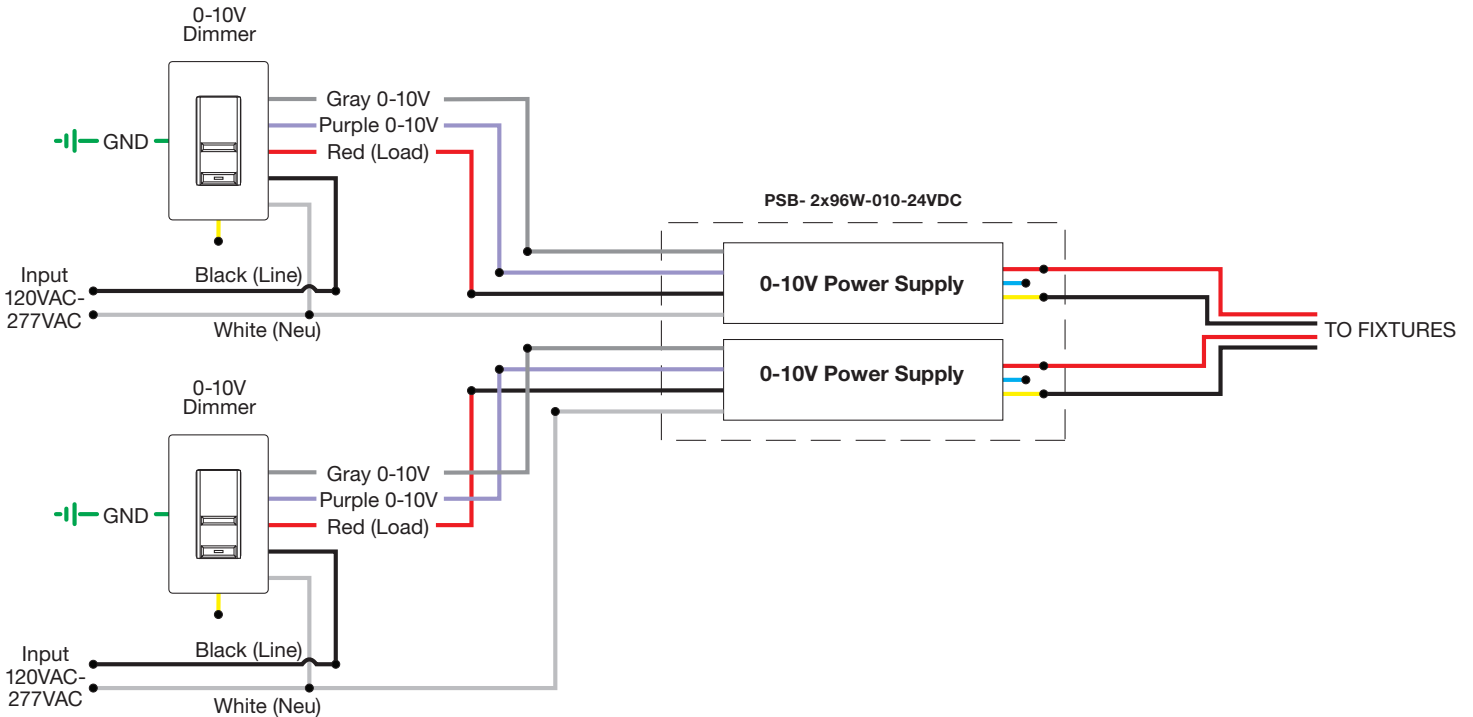

PROJECT	FIXTURE TYPE	DATE
---------	--------------	------

ELECTRONIC LOW-VOLTAGE (ELV) POWER SUPPLIES & RECOMMENDED DIMMERS ^{†‡}				
ORDERING CODES	PS-60L-ELV-24VDC 	PSB-60W-ELV-24VDC 	PSB-2X60W-ELV-24VDC 	PSB-100W-ELV-24VDC
SPECIFICATIONS				
MAXIMUM LOAD	60W NON-IC, 50W-IC (FITS IN JBOX)	60W	2X60W	96W
INPUT VOLTAGE	120VAC	120VAC	120VAC	120VAC
OUTPUT VOLTAGE	24VDC	24VDC	24VDC	24VDC
DIMENSIONS	2.25" X 1.25" X 0.83"	8.125" X 2" X 1.75"	12.15" X 6.48" X 2.18"	9.25" X 3.5" X 2"
CLASSIFICATION	CLASS 2	CLASS 2	CLASS 2	CLASS 2
T-BAR MOUNTING	N/A	PSB-60W-ELV-24VDC-TB	PSB-2X60W-ELV-24VDC-TB	PSB-100W-ELV-24VDC-TB
IN WALL MOUNTING	N/A	PSB-60W-ELV-24VDC-IW	PSB-2X60W-ELV-24VDC-IW	PSB-100W-ELV-24VDC-IW
ELECTRONIC LOW-VOLTAGE (ELV) POWER SUPPLIES & RECOMMENDED DIMMERS ^{†‡}				
ORDERING CODES	PSB-2X100W-ELV-24VDC 	PSB-3X100W-ELV-24VDC 	PSB-4X100W-ELV-24VDC 	
SPECIFICATIONS				
MAXIMUM LOAD	2X96W	3X96W	4X96W	
INPUT VOLTAGE	120VAC	120VAC	120VAC	
OUTPUT VOLTAGE	24VDC	24VDC	24VDC	
DIMENSIONS	12.15" X 6.48" X 2.18"	14" X 10" X 3"	17" X 13" X 3"	
CLASSIFICATION	CLASS 2	CLASS 2	CLASS 2	
T-BAR MOUNTING	PSB-2X100W-ELV-24VDC-TB	PSB-3X100W-ELV-24VDC-TB	PSB-4X100W-ELV-24VDC-TB	
IN WALL MOUNTING	PSB-2X100W-ELV-24VDC-IW	N/A	N/A	
DIMMING AND CONTROLS				
LUTRON DIVA: DVELV-300P	•	•	•	
LUTRON SKYLARK: SELV-300P	•	•	•	
LUTRON RADIO RA2: RRD-6NA	•	•	•	
LUTRON MAESTRO: MAELV-600	•	•	•	
LEGRAND ADORNE: ADTP-703TUM4	•	•	•	

[†]22K - 57K color temperatures are compatible with 0-10V, ELV, and Lutron Hi-Lume® Power Supplies. Warm Dim (27D, 30D) color temperatures are only compatible with ELV power supplies. Tunable White color temperature is compatible with 0-10V, ELV, DMX, and Lutron Hi-Lume® Power Supplies. Color (RGB, RGB+W) and Static Color (Amber, Blue, Green, or Red) are compatible with DMX Power Supplies.

[‡]Electrical Panels using Siemens/Murray AFCI breakers are not compatible with this ELV transformer. Use 0-10 Volt power supplies with this breaker

With N-Lite Dimming Do Not use ELV power supplies, use only 0-10 volt or Uni drivers power supplies

**Up + Down Light fixtures and Systems can be controlled individually or together depending on the power supply selection.

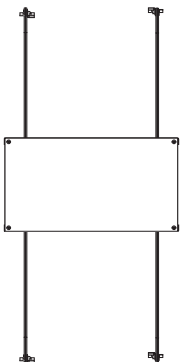

T-Bar Mounting Kit: Includes power supply, box cover, and T-bar hangers for installing Junction Box above ceiling with in easy reach. Comes with 4' of 14 gauge pair Teflon cables with quick secure connectors.

Ordering Codes : PSB-60W-ELV-24VDC-TB
PSB-100W-ELV-24VDC-TB
PSB-2X60W-ELV-24VDC-TB
PSB-2X100W-ELV-24VDC-TB
PSB-3X100W-ELV-24VDC-TB
PSB-4X100W-ELV-24VDC-TB

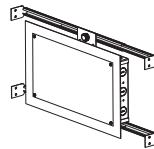

In-Wall Mounting Kit: Includes power supply, box cover and stud hangers for installing Junction Box in wall. Select "IW" in the options section of compatible power supply ordering codes if an In-Wall Mounting Kit is needed.

Ordering Codes 5.1" x 14.25": PSB-60W-ELV-24VDC-IW
PSB-100W-ELV-24VDC-IW

Ordering Codes 8.5" x 14.25": PSB-2X60W-ELV-24VDC-IW
PSB-2X100W-ELV-24VDC-IW

PROJECT		FIXTURE TYPE		DATE	
---------	--	--------------	--	------	--

SAMPLE WIRING DIAGRAMS 24VDC ELV

Application: ELV dimming for Static White

Dimming: Dimmable with ELV dimmer: Legrand, Adorne ADTP703TU; Lutron: Diva DVELV-300P, Skylark SELV-300P, Maestro MAELV-600 and Radio Ra 2

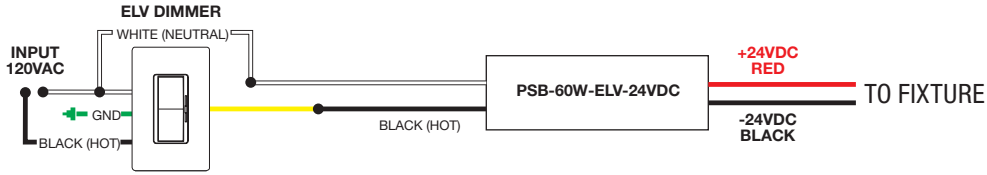

Application: ELV dimming for Static White

Dimming: Dimmable with ELV dimmer: Legrand, Adorne ADTP703TU; Lutron: Diva DVELV-300P, Skylark SELV-300P, Maestro MAELV-600 and Radio Ra 2

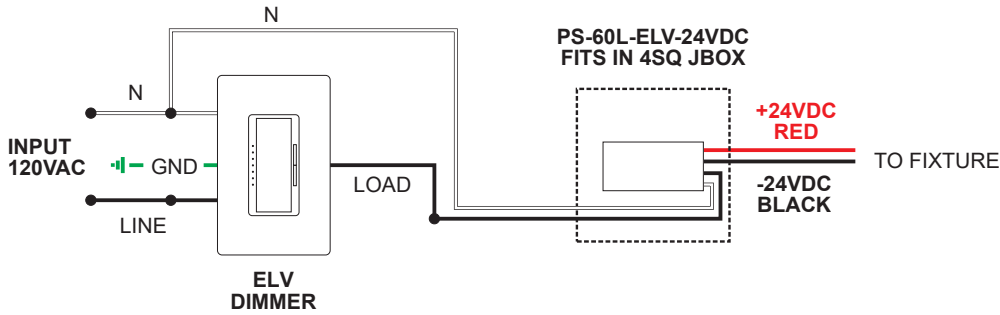

Application: Dual ELV dimming for Static White

Dimming: Dimmable with ELV dimmer: Legrand, Adorne ADTP703TU; Lutron: Diva DVELV-300P, Skylark SELV-300P, Maestro MAELV-600 and Radio Ra 2

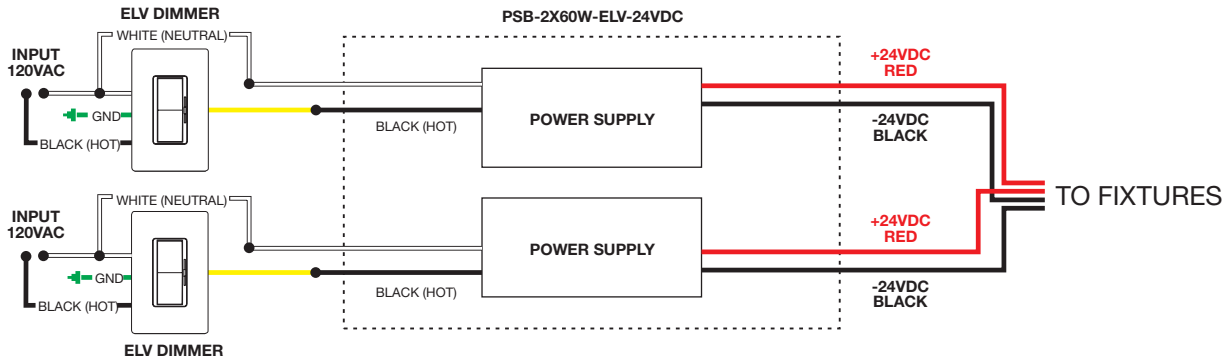

PROJECT		FIXTURE TYPE		DATE	
---------	--	--------------	--	------	--

OUTDOOR CONSTANT VOLTAGE REMOTE POWER SUPPLIES

24VDC, UNI - UNIVERSAL DIMMING WITH ELV, TRIAC, & 0-10V WET LOCATION

REV 04.26.21



Con-1-2CORD-O Cord conductors included

UNI STATIC WHITE POWER SUPPLY WET LOCATION

Universal Power Supply: 120/277VAC-24VDC with Universal dimming ELV, Triac or 0-10V dimmers. 100-0% Flicker free dimming. Aluminum casing for optimal heat dissipation. Isolated output power per NEC and UL safety requirements. UL & ETL recognized/ listed, meets UL8750, 1310 requirement. Auto-reset; short circuit, overload and thermal protection. Class 2 power supply. Efficient, High power factor > 0.90. Exceeds California Title 24 Requirements AAA rating. Efficiency > 84% Power Factor > 0.90. Case TC 90C° Max. Protection Input / Output Storage -30°C / +90°C Humidity 95% RH Max. Class 2 Power Supply Dimming ELV, Triac, 0-10V IP Rating IP67



Product	Wattage	Type	Voltage	Option
PSB	60W	UNI	24VDC	W
PSB Power Supply with Aluminum Casing	60Watts 96W	UNI Uni Driver	24VDC 24VDC	W Wet Location

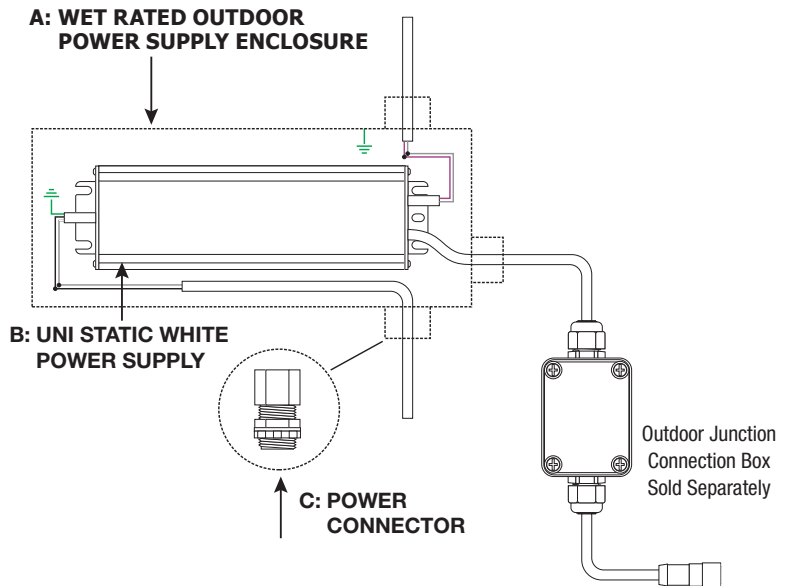
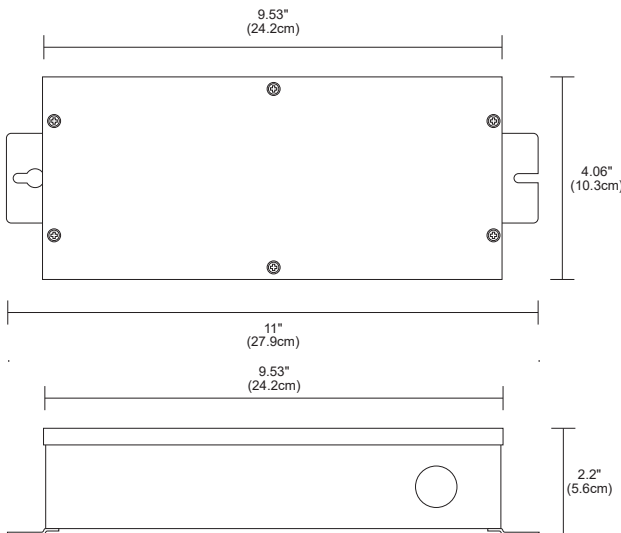

COMPATIBLE DIMMERS:

TRIAC DIMMING & CONTROLS
LUTRON SKYLARK: S2-L-WH
LUTRON DVLV-600P-WH
LUTRON DVLV-603P-WH
LUTRON MALV-600-WH
LUTRON MALV-1000-WH
LUTRON MA-R-XX

ELV DIMMING & CONTROLS
LUTRON DIVA: DVELV-300P
LUTRON SKYLARK: SELV-300P
LUTRON RADIO RA2: RRD-6NA
LUTRON MAESTRO: MAELV-600
LEGRAND ADORNE: ADTP-703TUM4
0-10 DIMMING & CONTROLS
PHILIPS SUNRISE: SR1200ZTUNV
LUTRON DIVA: DVTW-WH, DVSTV-WH
LUTRON NOVA T: NTSTV-DV-XX
LUTRON GRAFIK EYE QS: QSGRJ-XP
LUTRON RADIO RA2: RRD-10ND
LEVITON: LEV40050
LEVITON IP710-LFZ
LEGRAND: ADPD4FBL3P2W4

A. WET RATED OUTDOOR POWER SUPPLY ENCLOSURE

Use of Outdoor requires a Wet Location Junction Box to house the wire connection from the Power Supply. The Outdoor Connection Box is sold separately. A and B come together in the above product.

B. UNI STATIC WHITE POWER SUPPLY

The product above is the power supply inside an aluminum enclosure. Outdoor has a maximum run length of 40' at 2 watts per foot or 20' at 5 watts.

C. POWER CONNECTOR

Power Connector connects to the remote power supply. Comes connected to each end of the fixture

- Flicker free dimming
- Class 2 power supply
- Efficient, High power factor > 0.90
- Aluminum casing for optimal heat dissipation
- Isolated output power per NEC and UL safety requirements

- UL & ETL recognized/ listed, meets UL 8750, 1310 requirements
- Auto-reset; short circuit, overload and thermal protection
- The Solid State Constant Voltage Uni-Power Supply is compatible with most commercially available Dimmers:
 - Triac Dimmer: (Forward Phase) Typically used for the dimming of Incandescent and Low Voltage Magnetic Transformers
 - ELV Dimmer: (Reverse Phase) Dimming of Electronic Low Voltage Transformers and Power Supply's used for LED lighting
 - 0-10 Dimmer: Dims the Low Voltage side of a 0-10 volt power supply commonly used in large scale lighting or commercial applications.
- The Uni-Power Supply is recommended with any Siemens/Murray brand of arc fault breaker to overcome the issues with tripping the breakers with an ELV LED Low Voltage Drivers.

PROJECT	FIXTURE TYPE	DATE
---------	--------------	------

INDOOR CONSTANT VOLTAGE REMOTE POWER SUPPLIES

24VDC, UNIVERSAL DIMMING WITH ELV, TRIAC, & 0-10V FOR STATIC WHITE, WARM DIM

REV 04.26.21

UNIVERSAL POWER SUPPLIES & RECOMMENDED DIMMERS

ORDERING CODE	PSB-40W-UNI-24VDC	PSB-60W-UNI-24VDC	PSB-2X40W-UNI-24VDC	PSB-2X60W-UNI-24VDC
SPECIFICATIONS				
MAXIMUM LOAD	40W	60W	2X40W	2X60W
INPUT VOLTAGE	120-277VAC	120-277VAC	120-277VAC	120-277VAC
OUTPUT VOLTAGE	24VDC	24VDC	24VDC	24VDC
DIMENSIONS	12.4" X 3.12" X 2.18"	12.4" X 3.12" X 2.18"	12.15" X 6.48" X 2.18"	12.15" X 6.48" X 2.18"
CLASSIFICATION	CLASS 2	CLASS 2	CLASS 2	CLASS 2
T-BAR MOUNTING	PSB-40W-UNI-24VDC-TB	PSB-60W-UNI-24VDC-TB	PSB-2X40W-UNI-24VDC-TB	PSB-2X60W-UNI-24VDC-TB
IN-WALL MOUNTING	PSB-40W-UNI-24VDC-IW	PSB-60W-UNI-24VDC-IW	PSB-2X40W-UNI-24VDC-IW	PSB-2X60W-UNI-24VDC-IW

UNIVERSAL POWER SUPPLIES & RECOMMENDED DIMMERS

ORDERING CODE	PSB-96W-UNI-24VDC	PSB-2X96W-UNI-24VDC	PSB-3X96W-UNI-24VDC	PSB-4X96W-UNI-24VDC
SPECIFICATIONS				
MAXIMUM LOAD	96W	2X96W	3X96W	4X96W
INPUT VOLTAGE	120-277VAC	120-277VAC	120-277VAC	120-277VAC
OUTPUT VOLTAGE	24VDC	24VDC	24VDC	24VDC
DIMENSIONS	12.4" X 3.12" X 2.18"	12.15" X 6.48" X 2.18"	14" X 10" X 3"	17" X 13" X 3"
CLASSIFICATION	CLASS 2	CLASS 2	CLASS 2	CLASS 2
T-BAR MOUNTING	PSB-96W-UNI-24VDC-TB	PSB-2X96W-UNI-24VDC-TB	PSB-3X96W-UNI-24VDC-TB	PSB-4X96W-UNI-24VDC-TB
IN-WALL MOUNTING	PSB-96W-UNI-24VDC-IW	PSB-2X96W-UNI-24VDC-IW	NA	NA

ELV DIMMING & CONTROLS

LUTRON DIVA: DVELV-300P	•	•	•	•
LUTRON SKYLARK: SELV-300P	•	•	•	•
LUTRON RADIO RA2: RRD-6NA	•	•	•	•
LUTRON MAESTRO: MAELV-600	•	•	•	•
LEGRAND ADORNE: ADTP-703TUM4	•	•	•	•

0-10 DIMMING & CONTROLS

PHILIPS SUNRISE: SR1200ZTUNV	•	•	•	•
LUTRON DIVA: DDTV-WH, DVSTV-WH	•	•	•	•
LUTRON NOVA T: NTSTV-DV-XX	•	•	•	•
LUTRON GRAFIX EYE QS: QSGRJ-XP	•	•	•	•
LUTRON RADIO RA2: RRD-10ND	•	•	•	•
LEVITON: LEV40050	•	•	•	•
LEVITON IP710-LFZ	•	•	•	•
LEGRAND: ADPD4FBL3P2W4	•	•	•	•

TRIAC DIMMING & CONTROLS

LUTRON SKYLARK: S2-L-WH	•	•	•	•
LUTRON DIVA DVLV-600P-WH	•	•	•	•
LUTRON DIVA DVLV-603P-WH	•	•	•	•
LUTRON MAESTRO MALV-600-WH	•	•	•	•
LUTRON MAESTRO MALV-1000-WH	•	•	•	•
LUTRON MAESTRO MA-R-XX	•	•	•	•

- Flicker free dimming
- Aluminum casing for optimal heat dissipation
- Isolated output power per NEC and UL safety requirements
- UL & ETL recognized/ listed, meets UL 8750, 1310 requirements
- Auto-reset; short circuit, overload and thermal protection
- Class 2 power supply
- Efficient, High power factor > 0.90

- The Solid State Constant Voltage Uni-Power Supply is compatible with most commercially available Dimmers:
 - Triac Dimmer: (Forward Phase) Typically used for the dimming of Incandescent and Low Voltage Magnetic Transformers
 - ELV Dimmer: (Reverse Phase) Dimming of Electronic Low Voltage Transformers and Power Supplies used for LED lighting
 - 0-10 Dimmer: Dims the Low Voltage side of a 0-10 volt power supply commonly used in large scale lighting or commercial applications.
- The Uni-Power Supply is recommended with any Siemens/Murray brand of arc fault breaker to overcome the issues with tripping the breakers with an ELV LED Low Voltage Drivers.

*Tunable White requires Dual power Supplies and Controls. For single control use with our proprietary Tunable White Controller CDMX-1, refer to Universal Tunable White Power Supply Specifications.
Up + Down Light fixtures and Systems can be controlled individually or together depending on the power supply selection.

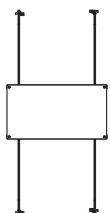

T-BAR Mounting Kit: Includes power supply, box cover, and T-bar hangers for installing Junction Box above ceiling with in easy reach. Comes with 4' of 14 gauge pair Teflon cables with quick secure connectors.

Ordering Codes : PSB-40W-UNI-24VDC-TB, PSB-60W-UNI-24VDC-TB, PSB-96W-UNI-24VDC-TB, PSB-2X40W-UNI-24VDC-TB, PSB-2X60W-UNI-24VDC-TB, PSB-2X96W-UNI-24VDC-TB, PSB-3X96W-UNI-24VDC-TB, PSB-4X96W-UNI-24VDC-TB

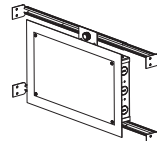

In-Wall Mounting Kit: Includes power supply, box cover and stud hangers for installing Junction Box in wall. Select "IW" in the options section of compatible power supply ordering codes if an In-Wall Mounting Kit is needed.

Ordering Codes 5.1" x 14.25": PSB-40W-UNI-24VDC-IW, PSB-60W-UNI-24VDC-IW, PSB-96W-UNI-24VDC-IW

Ordering Codes 8.5" x 14.25": PSB-2X40W-UNI-24VDC-IW, PSB-2X60W-UNI-24VDC-IW, PSB-2X96W-UNI-24VDC-IW

PROJECT	FIXTURE TYPE	DATE
---------	--------------	------

WIRING DIAGRAMS UNIVERSAL POWER SUPPLY

Application: ELV dimming for Static White and Warm Dim

Dimming: Dimmable with ELV dimmer: Legrand, Adorne ADTP703TU; Lutron: Diva DVELV-300P, Skylark SELV-300P, Maestro MAELV-600 and Radio Ra 2

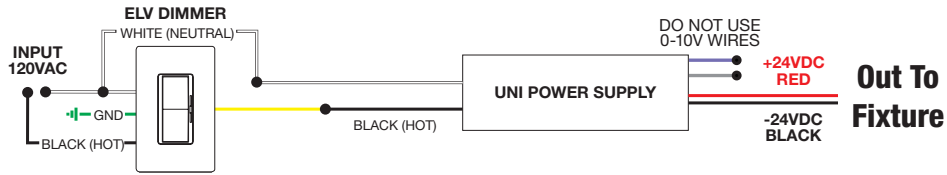

Application: 0-10V dimming for Static White

Dimming: Dimmable with 0-10V dimmer: Philips Sunrise: SR1200ZTUNV; Lutron Diva: DVTV-WH, DVSTV-WH; Lutron Nova T: NTSTV-DV-XX; Lutron Grafix EYE QS: QSGRJ-XP; Lutron Radio Ra2: RRD-10ND; Leviton: LEV40050; Leviton IP710-LFZ; Legrand: ADPD4FBL3P2W4

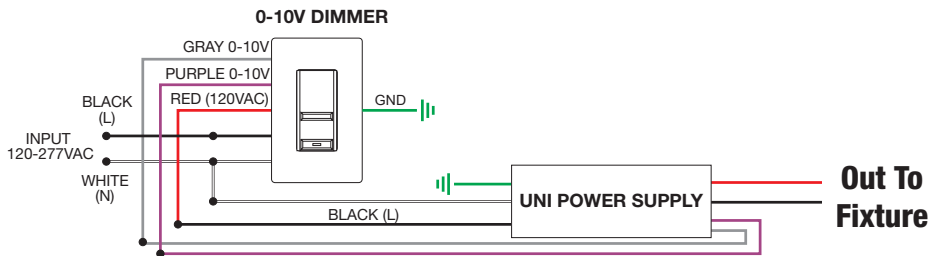

Application: Triac dimming for two power supplies, use for Static White

Dimming: Dimmable with Triac dimmer: Lutron: Skylark S2-L

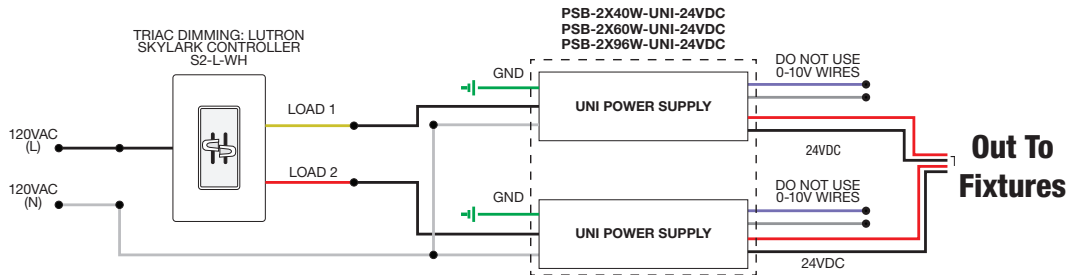

PROJECT	FIXTURE TYPE	DATE
---------	--------------	------

TUNABLE WHITE DMX CONTROLLER AND POWER SUPPLIES

24VDC INDOOR CONSTANT VOLTAGE POWER SUPPLIES WITH DRIVERS

REV 04.26.21

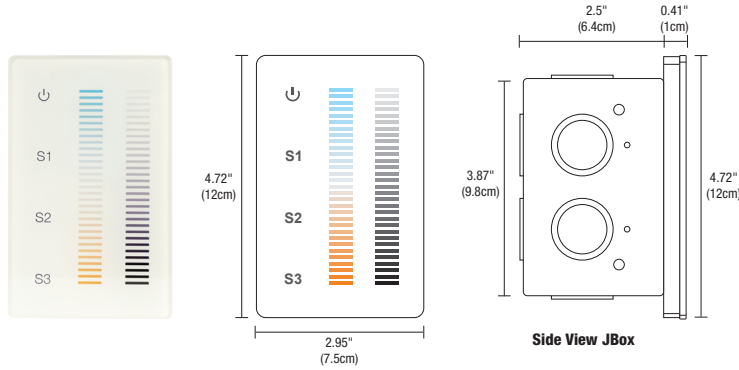

DESCRIPTION:

The Tunable White Touch Controller offers fast and accurate Color Temperature adjustment and the ability to regulate the Brightness Independently. The modern Glass faceplate features illuminated indicators, and a back-lit night light that softly illuminates the controller when powered off. Designed for Tunable White, and dual-color LED installations within a single zone. The two Vertical Touch sliders are precise and sensitive, allowing you to fine-tune your perfect Color Temperature at any point between **2000K** (Sunset) to **6500K** (Daylight White) while selecting over 250 levels of Brightness in a smooth, uninterrupted transition. Create Thousands of White Color Combinations while maintaining even Brightness and overall saturation. Easily save three pre-set scenes for different times of the day. Support health, performance, and general well-being using Human-Centric lighting by fine-tuning the biological effects that light has on the circadian cycle using the latest in LED technology. Includes a power adapter that fits behind the controller within a standard junction box and fits inside a standard single-gang receptacle (not for use in a multi-gang box). Use with an insulated, 24 AWG stranded, tinned copper wire (Belden #9841). Power Supplies are Sold Separately. Includes a 5 year pro-rated warranty.

APPLICATIONS:

Indoor

OUTPUT SIGNAL:

USITT DMX 512 (1990)

INSTALLATION:

Fits in a single gang 2.5" deep junction box. Not compatible with multi-gang boxes.

LABELS:

ROHS, FCC, Damp Location, ETL/UL

POWER INPUT:

120-240VAC

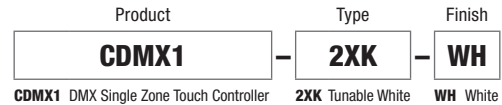
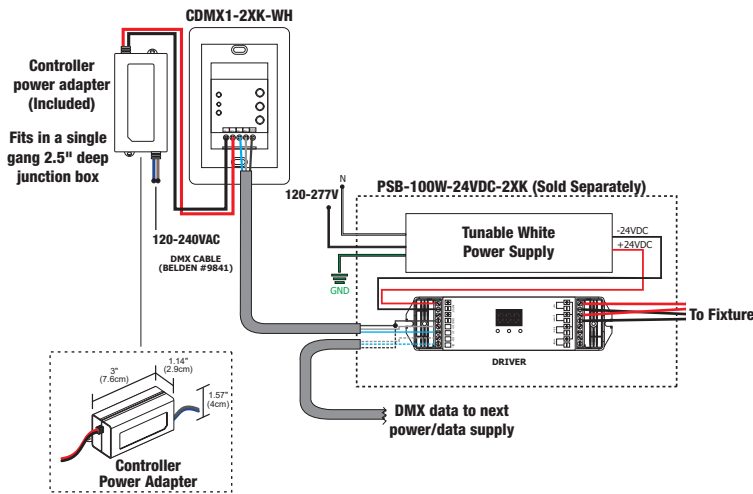

COLOR CHANGING (DMX) POWER SUPPLIES				
ORDERING CODE	PSB-100W-24VDC-2XK	PSB-2X100W-24VDC-2XK	PSB-3X100W-24VDC-2XK	PSB-4X100W-24VDC-2XK
SPECIFICATIONS				
MAXIMUM LOAD OF LED STRIP LENGTH	100W 5 WATTS - 20FT MAX. 10 WATTS - 10FT MAX.	2X100W 5 WATTS 2 X 20FT MAX. 10 WATTS - 2 X 10FT MAX.	3X100W 5 WATTS 3 X 20FT MAX. 10 WATTS - 3 X 10FT MAX.	4X100W 5 WATTS 4 X 20FT MAX. 10 WATTS - 4 X 10FT MAX.
INPUT VOLTAGE	120-277VAC	120-277VAC	120-277VAC	120-277VAC
OUTPUT VOLTAGE	24VDC	24VDC	24VDC	24VDC
DIMENSIONS	12.4" X 6.48" X 2.18"	14" X 10" X 3"	17" X 10" X 3"	17" X 10" X 3"
CLASSIFICATION	CLASS 2	CLASS 2	CLASS 2	CLASS 2
T-BAR MOUNTING	PSB-100W-24VDC-2XK-TB	PSB-2X100W-24VDC-2XK-TB	PSB-3X100W-24VDC-2XK-TB	PSB-4X100W-24VDC-2XK-TB
IN-WALL MOUNTING	PSB-100W-24VDC-2XK-IW	NA	NA	NA
DMX TUNABLE WHITE DIMMING & CONTROLS				
TUNABLE WHITE TOUCH CONTROLLER (CDMX1-2XK)	•	•	•	•

- Flicker free dimming
- Aluminum casing for optimal heat dissipation
- Isolated output power per NEC and UL safety requirements
- UL & ETL recognized/ listed, meets UL 8750, 1310 requirements

- Auto-reset; short circuit, overload and thermal protection
- Class 2 power supply
- Efficient, High power factor > 0.90

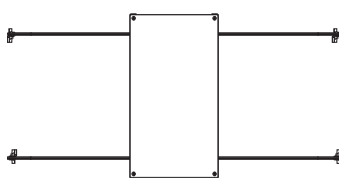

T-Bar Mounting Kit: Includes power supply, box cover, and T-bar hangers for installing Junction Box above ceiling with in easy reach. Comes with 4ft of 14 gauge pair Teflon cables with quick secure connectors.

Ordering Codes:
 PSB-100W-24VDC-2XK-TB
 PSB-2x100W-24VDC-2XK-TB
 PSB-3x100W-24VDC-2XK-TB
 PSB-4x100W-24VDC-2XK-TB

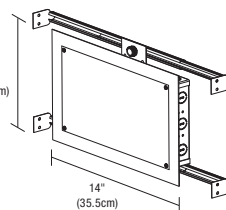

8.5" x 14" In-Wall Mounting Kit: Includes power supply, box cover and stud hangers for installing Junction Box in wall. Select "IW" in the options section of compatible power supply ordering codes if an In-Wall Mounting Kit is needed.

Ordering Codes:
 PSB-100W-24VDC-2XK-IW

PROJECT	FIXTURE TYPE	DATE
---------	--------------	------

Tunable White uses one or two power supplies, dependent on the controller or dimmer(s) used. Lutron Hi-Lume® can be used in both single or dual power formats, dependent on the controller or dimmer(s).

LUTRON HI-LUME® PREMIER .1% ECOSYSTEM®		
ORDERING CODES	2-WIRE ECOSYSTEM LTEA4U1UKL-CV240	3-WIRE ECOSYSTEM L3DA4U1UKL-CV240
SPECIFICATIONS		
MAXIMUM LOAD	5W-40W	5W-40W
INPUT VOLTAGE	120-277VAC	120-277VAC
OUTPUT VOLTAGE	24VDC	24VDC
DIMENSIONS	4" X 4.89" X 2.62"	4" X 4.89" X 2.62"
CLASSIFICATION	CLASS 2	CLASS 2
T-BAR MOUNTING	NA	NA
DIMMING AND CONTROLS		
RADIO RA2	•	•
HOMEWORKS QS	•	•
PHPM-3F-120	•	•
PHPM-3F-DV	•	•
BCI-0-10	•	•

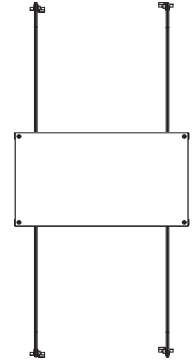

T-BAR Mounting Kit: Includes power supply, box cover, and T-bar hangers for installing Junction Box above ceiling with in easy reach. Comes with 4' of 14 gauge pair Teflon cables with quick secure connectors.

Ordering Code: L3D0-96W24V-U-TB

*Tunable White Color Temperature is compatible with 0-10V, ELV, DMX, and Lutron Hi-Lume® Power Supplies.

WIRING DIAGRAM: DMX Control with Lutron Grafik Eye Control Unit - PSB-100W-24VDC-2XK

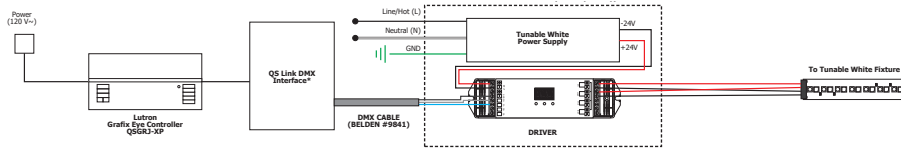

*PureEdge does not provide or sell this product

WIRING DIAGRAM: 0-10V Dimming with Lutron Grafik Eye Control Unit or Wall box controller - PSB-96W-010-24VDC-2XK

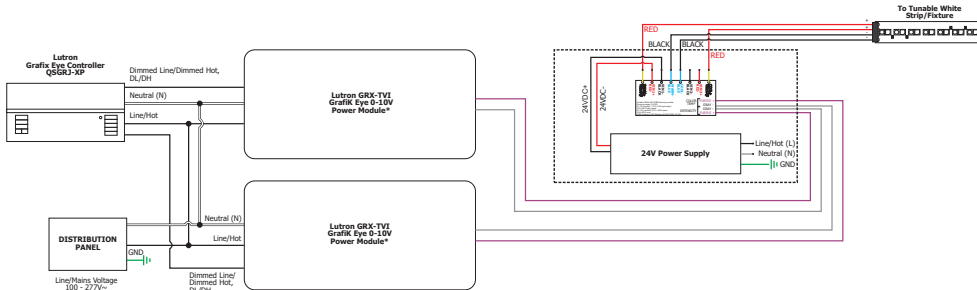

*PureEdge does not provide or sell this product



*PureEdge does not provide or sell this product

PROJECT		FIXTURE TYPE		DATE	
---------	--	--------------	--	------	--

INDOOR CONSTANT VOLTAGE REMOTE POWER SUPPLIES

24VDC, LUTRON ECOSYSTEM

LUTRON HI-LUME® PREMIER .1% ECOSYSTEM®†

ORDERING CODES	L3D0-96W24V-U	2-WIRE ECOSYSTEM LTEA4U1UKL-CV240	3-WIRE ECOSYSTEM L3DA4U1UKL-CV240
			
SPECIFICATIONS			
MAXIMUM LOAD	96W	5W-40W	5W-40W
INPUT VOLTAGE	120-277VAC	120-277VAC	120-277VAC
OUTPUT VOLTAGE	24VDC	24VDC	24VDC
DIMENSIONS	10.5" X 5.5" X 2"	4" X 4.89" X 2.62"	4" X 4.89" X 2.62"
CLASSIFICATION	CLASS 2	CLASS 2	CLASS 2
T-BAR MOUNTING	L3D0-96W24V-U-TB	NA	NA
DIMMING AND CONTROLS			
RADIO RA2	•	•	•
HOMEWORKS QS	•	•	•
PHPM-3F-120	•	•	•
PHPM-3F-DV	•	•	•
BCI-0-10	•	•	•

†24K - 57K color temperatures are compatible with 0-10V, ELV, and Lutron Hi-lume® Power Supplies. Warm Dim (27D, 30D) color temperatures are only compatible with ELV power supplies.

2-Wire EcoSystem Wiring Diagram

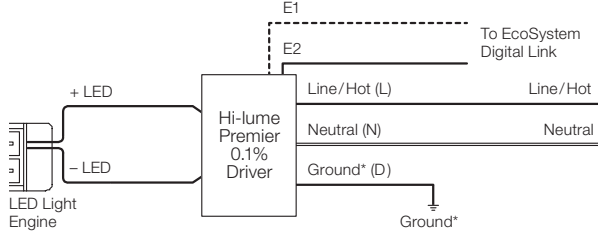

LTEA4U1UKL-CV240

3-Wire Wiring Diagram

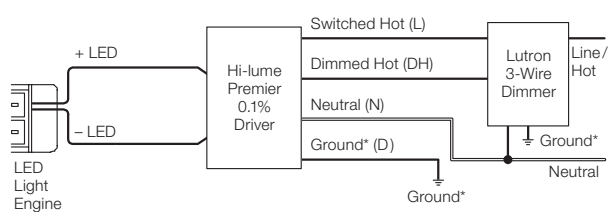

L3DA4U1UKL-CV240

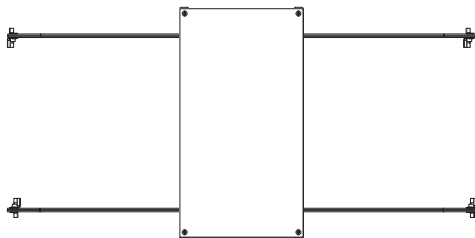

T-BAR Mounting Kit: Includes power supply, box cover, and T-bar hangers for installing Junction Box above ceiling with in easy reach. Comes with 4ft of 14 gauge pair Teflon cables with quick secure connectors.

Ordering Code: L3D0-96W24V-U-TB

PROJECT		FIXTURE TYPE		DATE	
---------	--	--------------	--	------	--

TUNABLE WHITE DMX WET LOCATION POWER SUPPLIES

24VDC OUTDOOR CONSTANT VOLTAGE

REV 04.26.21



PSB-100W-24VDC-2XK-W



PSB-2X100W-24VDC-2XK-W

DESCRIPTION

Our Surface Mount, exterior-rated Tunable White supplies utilize drivers for powering 24VDC constant voltage products. These products are the ideal power supplies for all Color Changing, damp or wet LED lighting solutions. Our constant voltage LED Power Supplies for outdoor environments are designed to provide regulated voltage through the DMX driver to the LED module. Designed for outdoor Cirrus, Soft Strip and Flex Neon.

- Universal Input Voltage
- Ripple Free
- IP65 – For Both Indoor and Outdoor Use
- No Minimum Load Requirement
- Class 2, Class P
- Auto-Reset Protection for Short Circuit & Over-Temperature
- Over Load Protection – CC Mode

CONTROLS

- CDMX1-2XK - Single zone DMX touch controller
- CTP - Multiple zone DMX touch controller

POWER INPUT

Universal Input voltage ranging from 120 to 277VAC

DIMENSIONS

PSB-100W-24VDC-2XK-W

Length: 10"
Width: 7.1"
Height: 3.3"
Weight: 1.6lbs

PSB-2X100W-24VDC-2XK-W

Length: 11.8"
Width: 9.1"
Height: 3.4"
Weight: 2.26lbs

LABELS

Assembled in America, Class P, Class 2, IP65, 120-277V, Dimmable, RoHS Compliant, 24VD

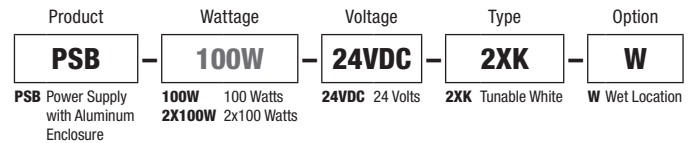

REQUIRED COMPONENTS SOLD SEPARATELY

WIRING DIAGRAM

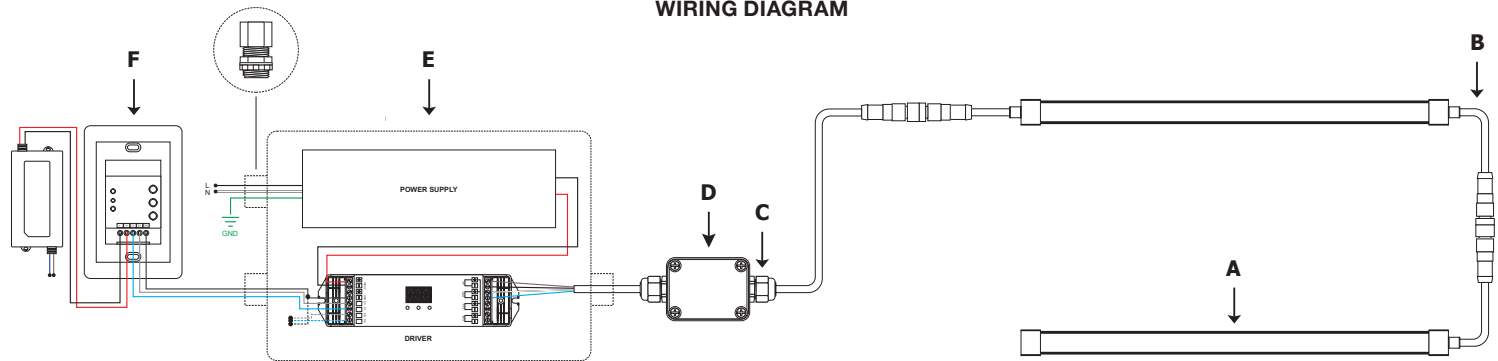

A. OUTDOOR 24VDC FIXTURE OR FLEX NEON

Wet location Cirrus, Flex Neon or Soft Strip. Please refer to fixture ordering code for incremental lengths. Cirrus, Flex Neon and Soft Strip are not field cuttable or submersible.

B. POWER CABLE CONNECTOR

The flexible power cable connector is designed to work in outdoor environments for safe and reliable connections.

C. POWER CONNECTOR

Sold Separately for Cirrus, Flex Neon and wet location Soft Strip.
*Included with Wet Location LED Soft Strips - comes connected to each end of the LED Soft Strip sealed in water-resistant silicone.

D. OUTDOOR CONNECTION BOX

Wet-rated low voltage Splice Box with connectors.

E. OUTDOOR RATED POWER SUPPLY WITH DMX DRIVER

Outdoor rated Power Supplies are required for use with a Outdoor LED Soft Strip and fixtures.

F. CONTROLLER (SOLD SEPARATELY)

CDMX1-2XK or CTP

PROJECT	FIXTURE TYPE	DATE
---------	--------------	------

PSB- X100W-24VDC

24 VOLT DC, NON-DIMMING POWER SUPPLY

DESIGNED BY GREGORY KAY | ASSEMBLED IN AMERICA

REV 04.26.21



PSB-100W-24VDC

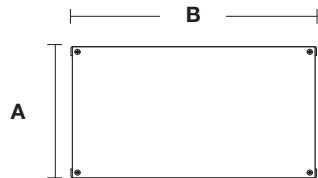

TOP VIEW

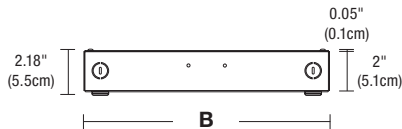

SIDE VIEW

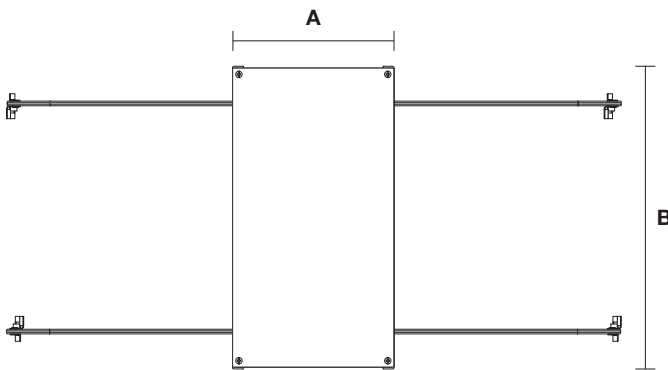

PSB-100W-24VDC-TB
(T-BAR GRID CEILING)

DESCRIPTION

Non-Dim Power Supply accepts input voltage in a range of 120 - 277VAC and outputs 24VDC power up to 4x100 watts. The enclosure provides a space inside for electrical connections. In-Wall Power Supply Kit includes power supply, box cover and stud hangers for installing Junction Box in wall. Power Supply features short circuit and overload and over temperature protection. Indoor applications only.

APPLICATIONS

Indoor*

*To avoid overheating the power supply, install it in a ventilated remote location where air flows. Maintain proper spacing among power supplies when multiple power supplies are installed in the same remote location.

MOUNTING

Surface mounted with conduit access

POWER INPUT

120-277VAC

POWER OUTPUT

Class 2; 24 volts DC 4A, up to 4x100 watts maximum

EFFICIENCY

90%

AMBIENT OPERATING TEMPERATURE

-25° C to 90° C

Product	Wattage	Voltage	Options
PSB	100W	24VDC	STANDARD (Leave Blank)
PSB Power Supply with Enclosure Box	100W 100 Watts 2X100W 2 x 100 Watts 3X100W 3 x 100 Watts 4X100W 4 x 100 Watts	24VDC 24 Volt DC	TB T-Bar Grid Ceiling IW* In-Wall Kit *Only 100W & 2x100W

STANDARD & T-BAR DIMENSIONS

	A	B
PSB-100W-24VDC	3.12"	12.4"
PSB-2X100W-24VDC	6.48"	12.15"
PSB-3X100W-24VDC	10"	14"
PSB-4X100W-24VDC	13"	17"



PSB-100W-24VDC-IW

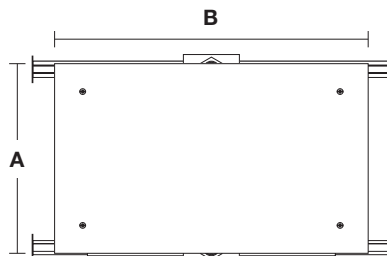

PSB-100W-24VDC-IW (IN WALL KIT)

IN-WALL DIMENSIONS

	A	B
PSB-100W-24VDC-IW	5.1"	14.25"
PSB-2X100W-24VDC-IW	8.5"	14.25"
PSB-3X100W-24VDC-IW	12"	14"
PSB-4X100W-24VDC-IW	15"	14"

PROJECT		FIXTURE TYPE		DATE	
---------	--	--------------	--	------	--

LED STRIP TM30 DATA

24VDC, STATIC WHITE, WARM DIM & DYNAMIC/TUNABLE WHITE

TM-30-15 DATA: The data below is for ST2A, ST5A, ST7A and ST10A bare LED Soft Strips. Consistent color temperatures throughout a single strip and among multiple strips is possible through a 3 phase binning process in which each order is inspected with a color meter to ensure uniformity.

2200K | Rf: 90.5 | Rg: 99.9

Color Vector Graphic

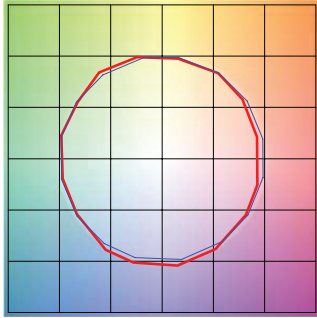

■ Test ■ Reference

GRAPHIC SHIFTS %			
HUE BIN	Rf	CHROMA	HUE
1	88.3	-5.2%	1.0%
2	90.1	-3.6%	3.7%
3	87.5	-0.5%	5.6%
4	93.9	-1.2%	1.3%
5	94.7	0.7%	2.1%
6	93.7	2.6%	0.7%
7	93.5	-1.5%	-2.2%
8	97.8	-0.4%	-0.2%
9	93.7	-1.5%	2.4%
10	90.8	-0.8%	4.9%
11	89.3	3.7%	5.4%
12	90.2	4.6%	1.0%
13	89.0	4.4%	-9.7%
14	75.4	0.6%	-15.1%
15	90.7	-1.7%	-5.0%
16	84.2	-4.4%	-9.1%

2400K | Rf: 90.2 | Rg: 99.3

Color Vector Graphic

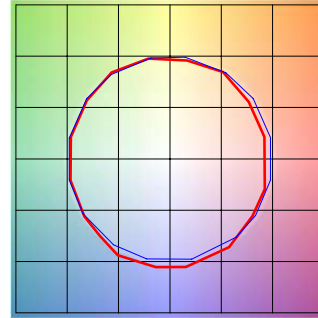

■ Test ■ Reference

GRAPHIC SHIFTS %			
HUE BIN	Rf	CHROMA	HUE
1	89.0	-4.8%	1.1%
2	90.4	-3.7%	3.2%
3	88.1	-0.7%	5.2%
4	93.0	-2.1%	0.9%
5	94.5	-0.1%	2.0%
6	94.7	1.7%	0.6%
7	93.7	-1.9%	-1.5%
8	96.8	-1.2%	0.2%
9	91.9	-1.8%	3.7%
10	88.8	-0.9%	6.1%
11	87.5	3.8%	7.1%
12	89.6	4.3%	0.3%
13	88.1	4.2%	-9.1%
14	82.5	2.8%	-10.6%
15	91.4	-2.1%	-4.2%
16	84.0	-3.6%	-9.9%

2700K | Rf: 89.5 | Rg: 98.3

Color Vector Graphic

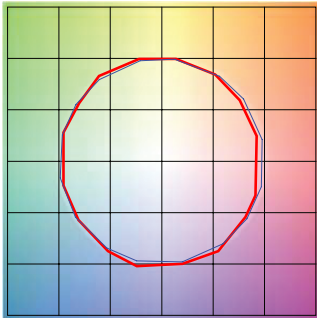

■ Test ■ Reference

GRAPHIC SHIFTS %			
HUE BIN	Rf	CHROMA	HUE
1	88.6	-5.2%	0.9%
2	90.3	-3.6%	2.9%
3	88.4	-1.5%	5.0%
4	91.9	-2.5%	1.4%
5	93.5	-0.9%	2.3%
6	95.7	0.9%	-0.4%
7	91.1	-3.7%	-0.5%
8	95.8	-2.0%	0.4%
9	90.5	-2.6%	4.5%
10	84.9	-1.1%	8.7%
11	85.0	2.3%	9.8%
12	88.1	5.5%	1.5%
13	90.9	2.9%	-5.2%
14	86.2	4.3%	-8.9%
15	90.7	-2.4%	-3.6%
16	83.0	-2.7%	-11.3%

3000K | Rf: 88.7 | Rg: 98.2

Color Vector Graphic

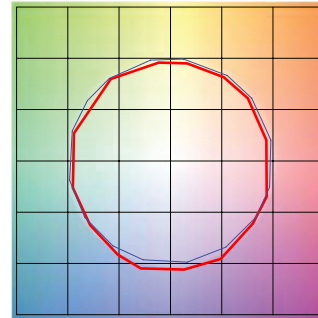

■ Test ■ Reference

GRAPHIC SHIFTS %			
HUE BIN	Rf	CHROMA	HUE
1	88.3	-5.2%	0.8%
2	90.2	-3.7%	2.7%
3	88.3	-1.6%	4.9%
4	92.2	-2.0%	1.8%
5	91.0	-3.5%	1.8%
6	95.8	0.4%	-0.4%
7	90.2	-4.4%	-0.0%
8	94.8	-2.6%	0.8%
9	89.2	-2.9%	6.0%
10	81.4	-1.5%	9.7%
11	82.9	2.3%	10.5%
12	88.3	6.7%	1.9%
13	91.9	2.8%	-4.0%
14	86.3	4.9%	-8.3%
15	87.1	-1.2%	-6.1%
16	83.2	-1.7%	-11.6%

3500K | Rf: 88.1 | Rg: 97.1

Color Vector Graphic

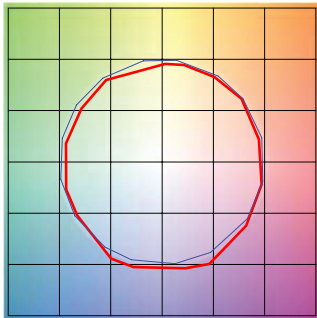

■ Test ■ Reference

GRAPHIC SHIFTS %			
HUE BIN	Rf	CHROMA	HUE
1	87.8	-5.2%	1.0%
2	90.8	-3.3%	2.3%
3	89.8	-1.6%	3.9%
4	91.0	-2.7%	0.9%
5	90.0	-5.4%	0.7%
6	95.6	-0.9%	-0.4%
7	90.0	-5.3%	1.4%
8	91.8	-3.6%	3.0%
9	87.1	-2.9%	7.3%
10	80.1	-1.3%	12.2%
11	81.8	4.1%	10.5%
12	88.2	5.1%	2.3%
13	92.4	2.1%	-3.8%
14	86.6	5.0%	-7.9%
15	86.2	-0.7%	-6.8%
16	84.5	-2.1%	-7.0%

5700K | Rf: 87.6 | Rg: 98.0

Color Vector Graphic

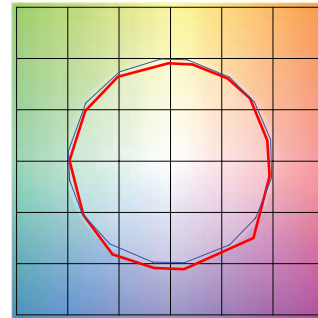

■ Test ■ Reference

GRAPHIC SHIFTS %			
HUE BIN	Rf	CHROMA	HUE
1	87.9	-3.9%	1.5%
2	92.3	-1.7%	2.7%
3	91.0	-1.2%	2.4%
4	91.5	-1.2%	1.6%
5	86.2	-5.9%	-0.4%
6	93.5	-3.2%	-0.2%
7	93.1	-3.8%	0.6%
8	85.9	-4.6%	5.9%
9	83.6	-4.0%	12.7%
10	75.8	-0.6%	13.6%
11	80.2	4.3%	10.4%
12	83.4	3.4%	1.8%
13	90.8	5.0%	-2.0%
14	91.8	1.3%	-3.3%
15	79.4	8.6%	-12.7%
16	93.4	-2.7%	-0.2%

PROJECT	FIXTURE TYPE	DATE
---------	--------------	------