

PSB-60W-UNI-24VDC

60WATT, 24VDC, UNIVERSAL DIMMING (ELV, TRIAC, 0-10V) STATIC WHITE & WARM DIM

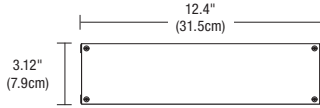

PSB-60W-UNI-24VDC



Top View

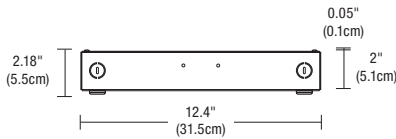

Side View



PSB-60W-UNI-24VDC-IW

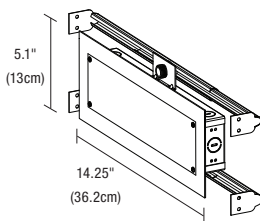

PSB-60W-UNI-24VDC-IW

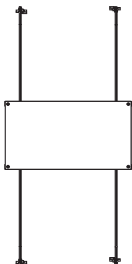

T-BAR Mounting Kit: Includes power supply, box cover, and T-bar hangers for installing Junction Box above ceiling with in easy reach. Comes with 4' of 14 gauge pair Teflon cables with quick secure connectors.

Ordering Code: PSB-60W-UNI-24VDC-TB

DESCRIPTION

Accepts input voltage in a range of 120 - 277VAC and outputs 24VDC power up to 60 watts. Can be used as a dimmable or non-dim Power Supply. Dims down 7% with an ELV dimmer or a 0-10 volt dimmer when two additional wires are connected to the dimmer. The enclosure provides a space inside for electrical connections. In-Wall Power Supply Kit includes power supply, box cover and stud hangers for installing Junction Box in wall. Power Supply features short circuit and overload and over temperature protection. Indoor applications only.

APPLICATIONS: Indoor*

To avoid overheating the power supply, install it in a ventilated remote location where air flows. Maintain proper spacing among power supplies when multiple power supplies are installed in the same remote location.

MOUNTING

Surface mounted with conduit access

POWER INPUT

120-277 volts AC, 50/60Hz

POWER OUTPUT

Class 2; 24 volts DC 4A, 60 watts maximum

EFFICIENCY

85%

DIMENSIONS

PSB-60W-UNI-24VDC: 12.4" x 3.12" x 2.18"

PSB-60W-UNI-24VDC-IW: 14.25" x 5.1" x 2.1"

AMBIENT OPERATING TEMPERATURE

-25C to 40C

ELV DIMMER TYPE

Legrand: Adorne ADTP703TU

Lutron: Diva DVELV-300P, Skylark SELV-300P,

Maestro MAELV-600 and Radio RA 2

0-10 DIMMER TYPE

Lutron: Radio RA2 (with GRX-TVI), Grafik Eye Qs (with GRX-TVI), Diva (with PP20); Nova T

Philips: Sunrise SR1200ZTUNV

Leviton: IP710-DL

DIMMING CURVE

Linear, Logarithmic 100% - 7% (HydraDrive)

Product	Wattage	Dimming	Voltage	Options
PSB	60W	UNI	24VDC	STANDARD (Leave Blank)
<small>PSB Power Supply with Enclosure Box</small>	<small>60W 60 Watt</small>	<small>UNI Universal Power Supply</small>	<small>24VDC 24 Volt DC</small>	<small>IW In-Wall Kit TB T-Bar TBCP T-Bar Chicago Plenum</small>

The Solid State Constant Voltage Uni-Power Supply is compatible with most commercially available Dimmers:

Triac Dimmer : (Forward Phase) Typically used for the dimming of Incandescent and Low Voltage Magnetic Transformers

ELV Dimmer : (Reverse Phase) Dimming of Electronic Low Voltage Transformers and Power Supply's used for LED lighting

0-10 Dimmer : Dims the Low Voltage side of a 0-10 volt power supply commonly used in large scale lighting or commercial applications.

*Title 24 with JA8 listed PureEdge products and systems

The Uni-Power Supply is recommended with any Siemens/Murray brand of arc fault breaker to overcome the issues with tripping the breakers with ELV Low Voltage Drivers.

PROJECT	FIXTURE TYPE	DATE
---------	--------------	------

PSB-60W-UNI-24VDC

60WATT, 24VDC, UNIVERSAL DIMMING (ELV, TRIAC, 0-10V) STATIC WHITE & WARM DIM

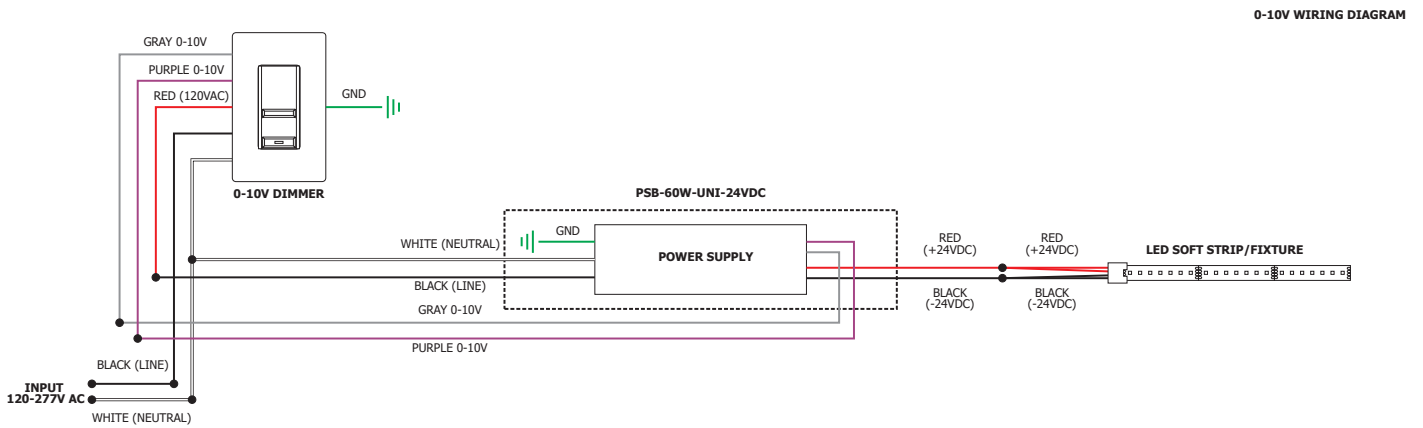
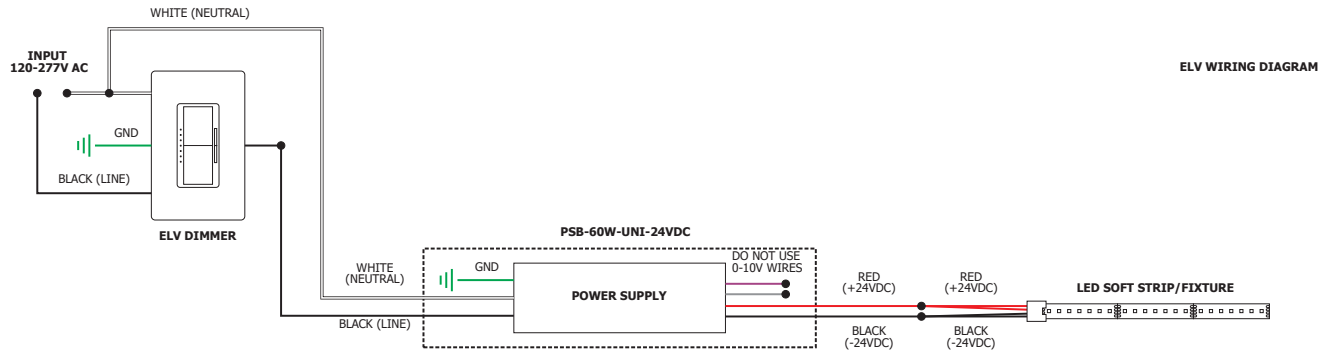

PROJECT	FIXTURE TYPE	DATE