

TUBO SMALL TRACK HEAD

24VDC INTEGRATED LED, STATIC WHITE & WARM DIM TECHNOLOGY

REV 01.19.21



T24-TUBS-SP-30K-WH

DESCRIPTION

The Tubo Small Track Head is an 8-watt luminaire that delivers up to 523 lumens blending practical technology with minimalist aesthetics making the most out of ceiling space while exhibiting a simple, modern design. Being part of an entirely Low Voltage 24VDC system, it offers unsurpassed efficiency in comparison to traditional track lighting systems. The cylindrical flat-back design houses the heat-sink, LED module, and integrated driver offering 360° horizontal rotation and 90° vertical aiming. Available in five Color Temperatures including Warm Dim (**30D**), that dims from 3000K-1800K exhibiting designer-grade color rendering as high as 98 CRI and R9-90. Choose from four different beam spreads as well as multiple lens accessories, including field-changeable, optic reflectors. With every element designed to be slender and unobtrusive, the Tubo Small provides superb illumination and functionality within a small package.

MOUNTING OPTIONS

Compatible with TruTrack Recessed Track (TR24-1C, TR24-2C) Pipeline Systems including Modular Suspension, Pipeline Track Suspension with Up Light and Pipeline Stem Mount Wall/Display (P1SDM, PT, PSTU2CR, PSTU2CR) and Surface Mount track (TS24-1C)

REMOTE POWER SUPPLIES (SOLD SEPARATELY)

- 24VDC Remote 010 Remote Power Supply

DIMMING

- Compatible with Lutron Diva, Skylark and Legrand 0-10 Volt dimmers
- Dimmable to 1%, Flicker less than 2%

LAMPING

COLOR TEMPERATURE	BEAM ANGLE REFERENCE 40°				
	24K	27K	30K	30D	35K
TOTAL LUMENS	523	427	494	428	485
WATTS	8.33	8.34	8.6	6.52	8.79
LUMENS PER WATT (lm/w)	63	51.2	55.5	65.7	55.2
CRI	92.7	96.5	92.8	96.4	98
TM-30 DATA	R9: 61 Rf: 91.3 Rg: 98.9	R9: 95 Rf: 93.2 Rg: 99.3	R9: 65 Rf: 90.7 Rg: 99.9	R9: 83 Rf: 93.1 Rg: 100.5	R9: 99 Rf: 93.3 Rg: 99.5
LAMP LIFE	60,000 Hours, 70% Lumen Maintenance				



T24-TUBS-SP-30K-BK

ACCESSORIES

Field adjustable single optic reflectors produce a smooth uniform beam at 20° / 40° / 60° beam spread options

TUBO SMALL	ORDERING CODE
20° BEAM SPREAD	REF-1.375-SP
25° BEAM SPREAD	REF-1.375-NF
40° BEAM SPREAD	REF-1.375-FL
60° BEAM SPREAD	REF-1.375-WF

APPLICATIONS

Designed for indoor use only, dry and damp locations. Ideal applications in Commercial, Retail, Residential, Hospitality, Education, and Healthcare Institutions.

WARRANTY / LABELS

Pro-rated 5 year warranty. Assembled in America, ETL (Conforms to UL1598 and CSA 22.2 #250.0) RoHs, Title 24 (Remote power supplies only)

FINISHES

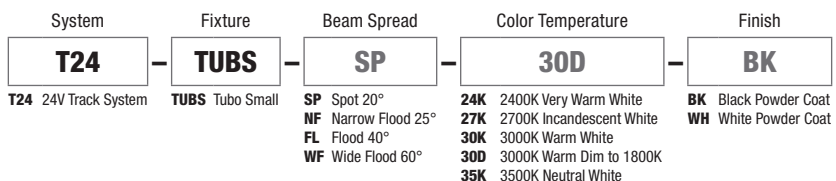
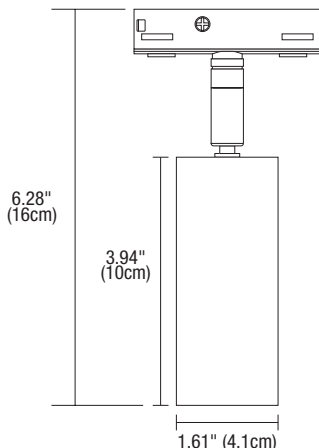
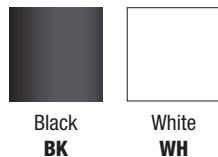

PROJECT	FIXTURE TYPE	DATE
---------	--------------	------



TUBO SMALL TRACK HEAD

24VDC INTEGRATED LED, STATIC WHITE & WARM DIM TECHNOLOGY

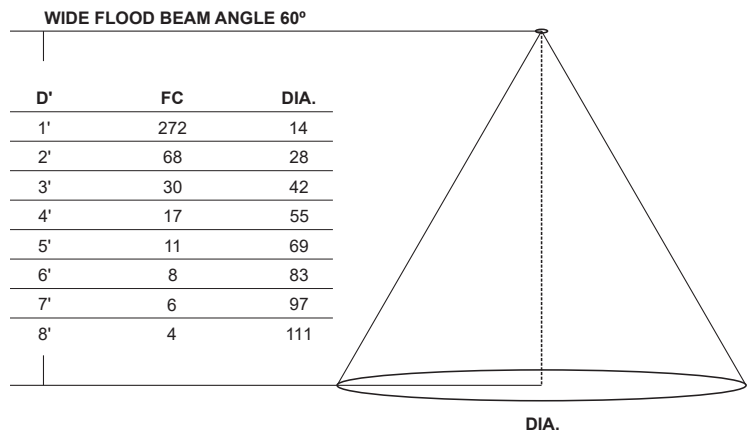
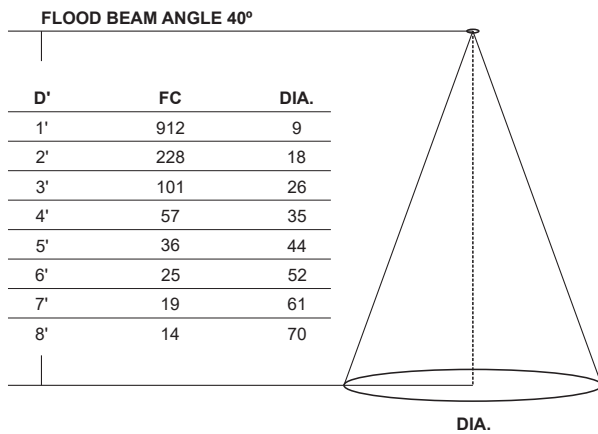
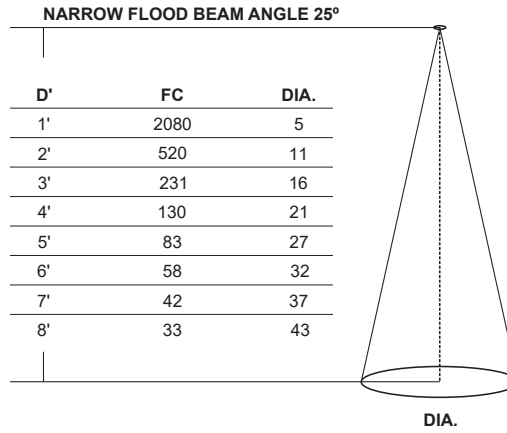
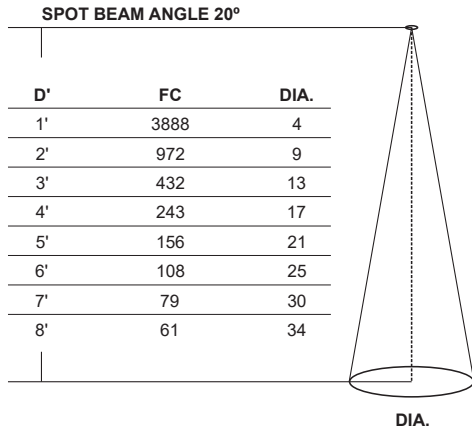
D - Distance from TUBO SMALL fixture (FT)
 FC - Initial foot candles at the center of beam
 DIA - Diameter (IN)



ADDITIONAL LENSES & ACCESSORIES

FILM LENS SOFT FOCUS		FILM LENS LINEAR SPREAD	
DIFFUSES A BEAM PATTERN TO PROVIDE EVEN ILLUMINATION		LINEAR SPREAD LENS DIRECTS LIGHT THROUGH 10° / 15° / 25° DEGREE BEAM LENS CREATING AN ELONGATED SHAPE, USED FOR LONG RECTANGLE PAINTINGS OR ART WORK. LINEAR SPREAD LENS DIRECTS LIGHT THROUGH 35° / 40° / 60° DEGREE BEAM LENS CREATING AN ELONGATED OVAL SHAPE, USED IN ART WORK AND WALL WASH APPLICATIONS.	
PRODUCT	TUBO SMALL 	PRODUCT	TUBO SMALL 
ORDERING CODE	LF-TUBS-SF, MF, WF	ORDERING CODE	LF-TUBS-LS

PROJECT	FIXTURE TYPE	DATE
---------	--------------	------

T24 TM30 DATA

24VDC INTEGRATED LED, STATIC WHITE & WARM DIM TECHNOLOGY

TM-30 DATA: The data below is for Tubo Small. Consistent color temperatures among multiple track heads is possible through a 3 phase binning process in which each order is inspected with a color meter to ensure uniformity.

2400K | Rf: 91.2 | Rg: 96.8
Color Vector Graphic

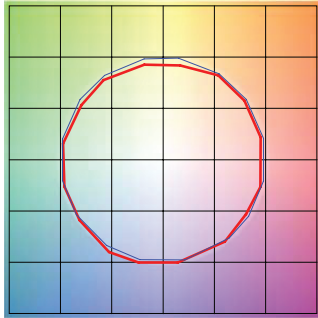

■ Test ■ Reference

HUE BIN	Rf	GRAPHIC SHIFTS %	
		CHROMA	HUE
1	92.0	-2.4%	1.5%
2	94.7	-2.1%	0.0%
3	95.4	-1.9%	-0.1%
4	88.7	-6.7%	-3.1%
5	92.8	-5.6%	1.0%
6	92.7	-3.4%	3.4%
7	89.9	-4.3%	4.1%
8	92.4	-1.4%	4.4%
9	89.0	-0.6%	5.8%
10	88.9	0.4%	6.2%
11	89.7	4.0%	5.4%
12	92.6	3.0%	-0.7%
13	90.9	1.1%	-7.0%
14	89.9	0.5%	-5.8%
15	92.1	-3.2%	0.1%
16	88.9	-1.7%	-6.3%

2700K | Rf: 87.7 | Rg: 96.1
Color Vector Graphic

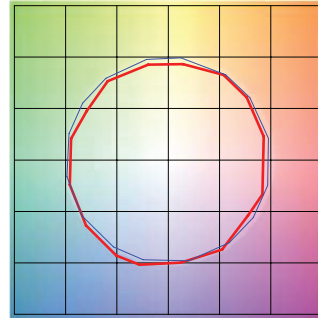

■ Test ■ Reference

HUE BIN	Rf	GRAPHIC SHIFTS %	
		CHROMA	HUE
1	88.0	-4.3%	2.6%
2	91.6	-2.4%	2.0%
3	93.7	-1.4%	1.9%
4	88.9	-5.6%	-3.1%
5	92.3	-5.5%	-0.5%
6	92.9	-3.5%	0.1%
7	84.5	-7.5%	4.6%
8	90.8	-3.0%	4.4%
9	84.5	-1.3%	8.3%
10	83.9	2.0%	9.8%
11	87.2	5.3%	7.1%
12	89.2	5.4%	-2.6%
13	88.7	0.3%	-7.8%
14	86.8	1.7%	-9.3%
15	87.6	-5.4%	-1.3%
16	83.6	-3.3%	-9.5%

3000K | Rf: 88.1 | Rg: 99.7
Color Vector Graphic

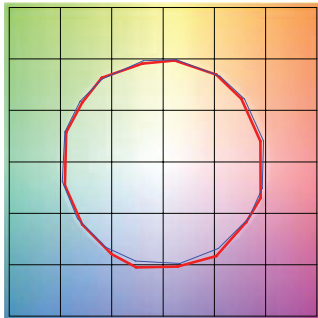

■ Test ■ Reference

HUE BIN	Rf	GRAPHIC SHIFTS %	
		CHROMA	HUE
1	92.5	-3.1%	0.3%
2	93.3	-2.3%	1.9%
3	90.9	-0.8%	3.9%
4	94.3	-1.1%	1.4%
5	92.5	-2.6%	1.5%
6	96.4	1.2%	-0.3%
7	92.6	-2.5%	-0.0%
8	96.9	-1.4%	0.2%
9	92.3	-1.8%	4.3%
10	86.6	-0.7%	7.0%
11	86.5	2.4%	8.2%
12	89.8	5.9%	1.7%
13	93.9	2.6%	-2.7%
14	89.4	5.1%	-5.8%
15	90.1	-0.1%	-4.7%
16	86.5	0.3%	-9.7%

3500K | Rf: 86.1 | Rg: 95.5
Color Vector Graphic

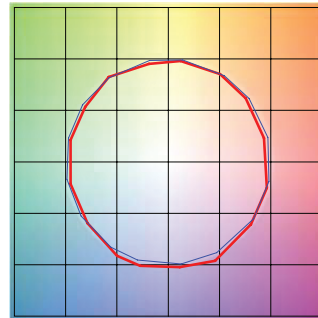

■ Test ■ Reference

HUE BIN	Rf	GRAPHIC SHIFTS %	
		CHROMA	HUE
1	90.8	-3.8%	0.3%
2	92.3	-2.8%	2.1%
3	89.7	-1.0%	4.3%
4	92.6	-1.4%	1.7%
5	91.8	-3.1%	1.3%
6	96.2	0.8%	-0.4%
7	92.9	-3.2%	0.2%
8	94.3	-2.5%	1.5%
9	90.4	-2.5%	5.2%
10	84.3	-1.4%	9.5%
11	83.1	3.5%	9.8%
12	88.2	4.8%	3.4%
13	94.0	2.7%	-2.0%
14	88.7	5.9%	-5.8%
15	88.7	0.7%	-5.9%
16	86.8	-0.7%	-6.7%

3000D | Rf: 89.8 | Rg: 101.4
Color Vector Graphic

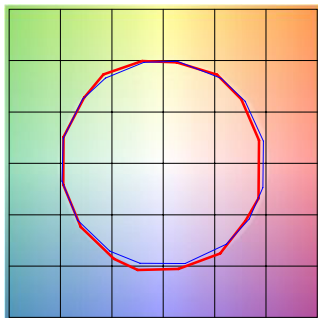

■ Test ■ Reference

HUE BIN	Rf	GRAPHIC SHIFTS %	
		CHROMA	HUE
1	90.2	-4.2%	1.5%
2	90.9	-2.0%	3.7%
3	87.9	0.8%	5.5%
4	92.1	-0.9%	0.6%
5	93.0	1.5%	1.6%
6	92.2	3.9%	-0.2%
7	92.1	-0.3%	-2.0%
8	96.7	0.0%	-1.2%
9	92.5	-0.6%	3.7%
10	88.3	1.1%	7.0%
11	87.2	4.1%	7.4%
12	87.2	6.7%	-1.0%
13	88.2	3.8%	-7.2%
14	85.3	4.3%	-9.9%
15	90.9	-2.2%	-3.6%
16	83.4	-2.2%	-11.2%

PROJECT	FIXTURE TYPE	DATE
---------	--------------	------